



深圳市华浩德电子有限公司

Shenzhen Fahold Electronics Co.,Ltd.

地址：深圳市宝安区石岩街道石龙社区石环路 4 号星光工业园 C 栋二、四、五、六楼

Add.:Floor 2,4,5, 6 Building C, Starlight Industrial Park, NO. 4, Shihuan Road,Shilong Community, Shiyan Town, Bao'an District, Shenzhen, China.

Product Name: 产品名称	FD-100H 系列防水电源					
	FD-100H-038/B/C/D	24-38V	2.3-3.3A	CE <input checked="" type="checkbox"/>	FCC <input checked="" type="checkbox"/>	UL <input checked="" type="checkbox"/>
Product Model: 产品型号	FD-100H-042/B/C/D	30-42V	1.5-3.0A	CE <input checked="" type="checkbox"/>	FCC <input checked="" type="checkbox"/>	UL <input checked="" type="checkbox"/>
	FD-100H-054/B/C/D	36-54V	1.8-2.4A	CE <input checked="" type="checkbox"/>	FCC <input checked="" type="checkbox"/>	UL <input checked="" type="checkbox"/>
	FD-100H-076/B/C/D	45-76V	1.2-1.85A	CE <input checked="" type="checkbox"/>	FCC <input checked="" type="checkbox"/>	UL <input checked="" type="checkbox"/>
	FD-100H-143/B/C/D	72-143V	0.7-1.3A	CE <input checked="" type="checkbox"/>	FCC <input checked="" type="checkbox"/>	UL <input checked="" type="checkbox"/>

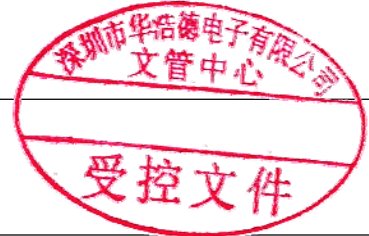

版本: REV.: 01

IGNATURE AND SEAL BY US /我司签字盖章		
日期:	2017-9-26	
Prepared By 编制	Checked By 审核	Approved By 批准

Please confirm and send it back with signature within 7 days. Otherwise we will assume your acceptance. And if any quality dissent, will execute according to this product specification.
 请确认后七日内回签，如不回签则视贵公司默认接受，在发生品质异常时按此份产品规格书执行。
CUSTOMER APPROVED SIGNATURE /客户承认盖章

Customer/客户:		
Customer Model No.客户型号:		
日期:		
ENG./工程	QA/品管	OTHER/其他

Comments 建议:

Feature特征:

- ◆ Constant current design. 恒流设计
- ◆ 3 in 1 dimming mode:0-10V,PWM,RX. 三合一调光
调光模式: 0-10v, PWM,RX
- ◆ Smoothly dimming(0-100%),can dim to off.
从0%-100%平滑调光, 且调光输出可关断
- ◆ TUV CB CE UL FCC Certified
- ◆ PROTECTION: Short Circuit, Open Circuit
保护: 短路保护, 开路保护
- ◆ Surge protection: 6KV.浪涌保护6KV
- ◆ SELV safe output design SELV. 安全输出设计

Application应用

- ◆ LED Advertising Sign,LED Architectural Lighting,LED Commercial Industrial Lighting,LED General Luminaries,LED广告牌, LED建筑照明, LED商业工业照明, LED灯具

Introduction 介绍

The document detail the electrical, mechanical and environmental specifications of a 80W constant current LED driver with 0-10V Dimming. This LED drive power supply is suitable only for LED load.

此份资料详细描述了一款 80W 系列带 0-10V 调光的 LED 恒流驱动电源的电器性能, 环境要求等。此款电源只适用于 LED 负载。

Model and Key parameters 型号和关键参数

Model 型号	Power (W) 功率	Output Voltage (Vdc) 输出电压	空载电压	Output current (mA) 输出电流	AC230V Efficiency(Typ.) 效率	AC100V Efficiency(Typ.) 效率
FD-100H-038/B/C/D	100	24-38	40	2300-3300	90%	87%
FD-100H-042/B/C/D	100	30-42	42	1500-3000	90%	87%
FD-100H-054/B/C/D	100	36-54	56	1800-2400	91%	88%
FD-100H-076/B/C/D	100	45-76	78	1200-1850	91.5%	88.5%
FD-100H-143/B/C/D	100	72-143	145	700-1300	92%	89%

Note:

- 1:测试条件为满载, 环境温度 25℃ Test conditions are full load, ambient temperature 25 °C
- 2: 可选字母 B,C,D 或空位, 表示输出增加不同的可选功能。默认空位表示可调电流 (基础机型);B 字母表示可三合一调光并可调电流, C 字母表示不可调光不可调电流, D 字母表示可三合一调光。
- 2: Optional letters B, C, D or empty, indicating that the output increases with different optional functions. The default position indicates that the current can be adjustable(basic model); letter B can be three-in-one dimming and fine-tuning current, letter C indicates that non dimmable and output current unadjustable, letter D refers to three-in-one dimming.

3:型号 C/D 后面标签上要写 YYYY,YYYY 代表输出电流, 如 FD-100H-42C-1800

The model C / D on the back of the label to write YYY and YYY for the output current, such as FD-100H-42C-1800

■ Technical data 技术参数

Input characteristics 输入特性	
Input Voltage 输入电压	100-277Vac
Input Frequency 输入频率	50/60Hz
Input Current (Typ.)输入电流 (典型值)	1300mAmax. @ 100-277Vac , 100% load
Inrush Current 输入电流	60Amax. @100Vac, 25℃
Power factor (Typ.) 功率因数 (典型值)	PF>0.9@100-277VAC, 100% load
THD 总谐波失真	THD<20% @100-277VAC, 100% load
Output characteristics 输出特性	
Current accuracy 电流精度	5%Io
No load Voltage 空载功耗	3Wmax
Ripple and Noise 纹波与噪声	500mVp-p
Line Regulation 线性调整率	5%Io
Load Regulation 负载调整率	5%Io
Turn On Delay Time 开机延时	Under normal conditions, the maximum delay time is 2 second
Protection functions 保护功能	
Open circuit 开路保护	When the LED disconnection the product is protected such as hiccup or when it is at the highest point of output voltage, the power supply shall be self-recovery when the fault condition is removed.当 LED 开路时, 产品进入保护状态, 如打嗝或钳在某输出最高电压状态, 产品不会损伤, 当故障排除或重新开机时, 电源恢复工作正常。
Short Circuit 短路保护	The input power shall decrease when the output rail short, the power supply shall be self-recovery when the fault condition is removed.当输出短路时输入功率会相应减小, 短路情况解除后, 电源自动恢复正常。
Environmental conditions 环境条件	
Operating Temperature 工作温度	-40℃ to +60℃
Operating Relative Humidity 湿度	10% to 90% RH, non-condensing
Storage Temperature 储存温度	-40℃ to +85℃
Storage Relative Humidity 储存湿度	10% to 90%RH, non-condensing (Sea level to 2,000 m)
Vibration 振动	10 to 500HZ Sweep at constant acceleration of 1.0G (depth: 3.5mm)for 1 Hour for each of the perpendicular axes X, Y, Z.

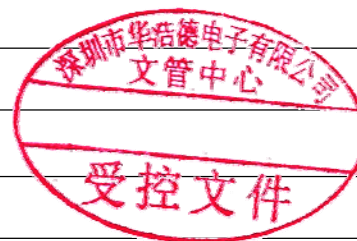

Degrees of Protection 防水等级	IP67
Safety compliance 安全标准	
Safety Standard 安规标准	GB19510.1,GB19510.14;EN61347-1,EN61347-2-13;UL8750, CSA C22.2No.250.13-12.
Dielectric Strength 介电强度	初级-次级: P-S:3750VAC/5mA/60S 初级-地: P-E:1500VAC/5mA/60S 次级-地: P-E:500VAC/5mA/60S
Insulation Resistance 绝缘电阻	I/P-O/P:>50M Ohms / 500VDC / 25°C / 70% RH.
Leakage Current 泄漏电流	The leakage current shall be less than 0.25mA for Class 2 at maximum input voltage
EMI	GB17743, GB17625.1; EN55015, EN61000-3-2, EN61000-3-3.
EMS	EN 61000-4-2, 3,4,5,6,8,11, EN 61547.
ESD 静电放电(静电) 免疫	静电放电/免疫 Severity Level 等级 Level3/3 级 空气放电: ±8KV Severity Level 等级 Level2/2 级 接触放电: ±4KV 性能标准: B
RF 射频场强度	射频电磁场药敏试验, 80-1000MHZ; Severity Level 等级 Level2/2 级, 3V/M; Performance Criterion 性能标准: A
EFT 电快速瞬变脉冲	Severity Level 等级: Level2/2 级 line to line 1.0kv 性能标准: B
Surge Immunity 浪涌雷击	Severity Level 等级: Level2/2 级, 差模 6.0kv Severity Level 等级: Level3/3 级, 共模 6.0kv Performance Criterion 性能标准: B
Reliability 可靠性	
Life Time 寿命	≥5Years H@230Vac, 100% load. See lifetime vs. Tc curve for the details
MTBF 平均无故障时间	≥ 200,000H@ 25°C, 230Vac, 80% load. (MIL-HDBK-217F)
Warranty 质保	5 years
Others 其它	
Dimensions 尺寸	172X66X38.2 (L*W*H)
Weight 重量	736±5g
Remark 备注	
<p>1. The parameters above including the power factor, THD, efficiency are all tested under the ambient temperature 25°C and humidity 50%, AC input 230V and 90% output load.此参数所得包括功率因数, 总谐波失真, 效率等所有测试均在 25°C 50%湿度 输入电压 230V 以及 90%输出负载的环境下测试。</p> <p>2. I_o is rate output current.</p>	

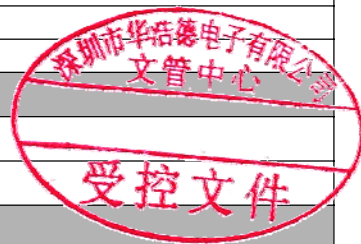

■ Dimmable feature 调光描述

Function			0-10V			PWM			RX			
Yes Or No			√			√			√			
0-10V	0	1	2	3	4	5	6	7	8	9	10	open
I _r	0	11%	20%	30%	40%	50%	60%	70%	80%	90%	100%	95%-108%
PWM	0	10%	20%	30%	40%	50%	60%	70%	80%	90%	100%	100%
I _r	0	6%	18%	30%	40%	50%	61%	71%	82%	92%	100%	95%-108%
RX	0	9KΩ	19KΩ	33KΩ	41KΩ	51KΩ	61KΩ	70KΩ	82KΩ	92KΩ	96KΩ	95-108KΩ
I _r	0	10%	20%	30%	40%	50%	60%	70%	80%	90%	100%	100%

Note:

- I_r is the output current percentages. I_r 为输出电流百分比
- I_r above is typical values. 以上 I_r 均为典型值

■ Efficiency vs. Load 效率负载

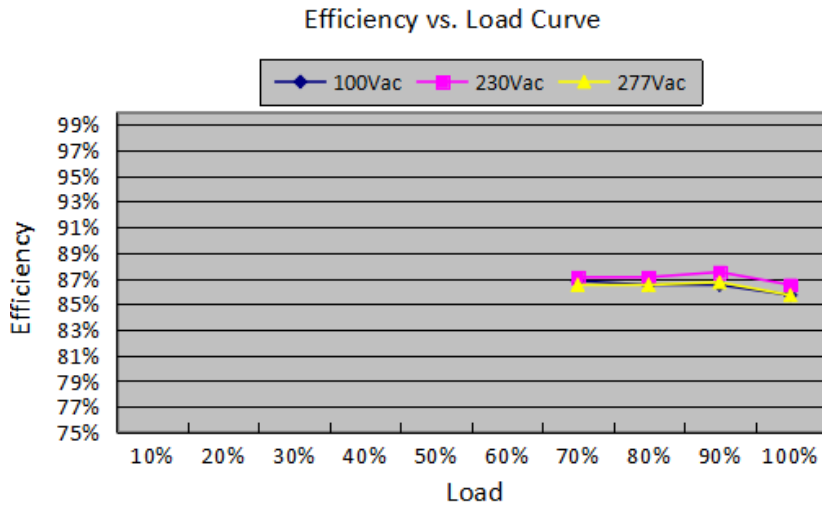

■ Power Factor 功率因素

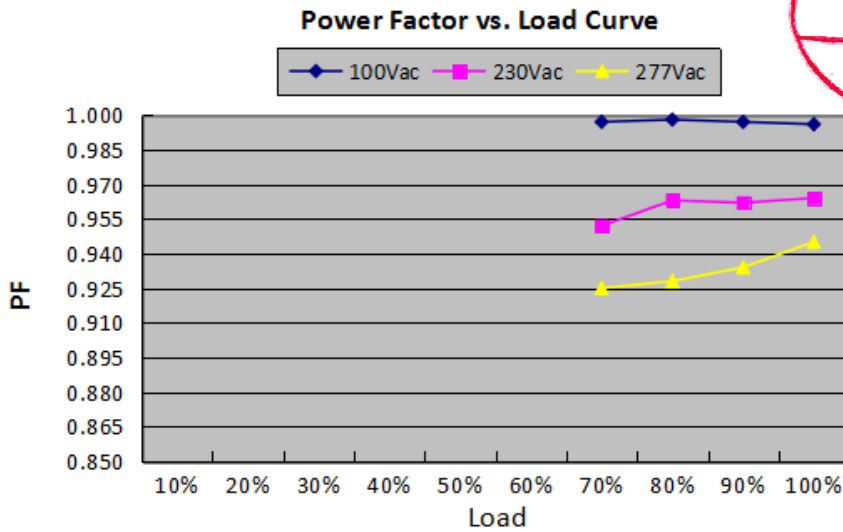

■ THD vs. Load THD 和负载

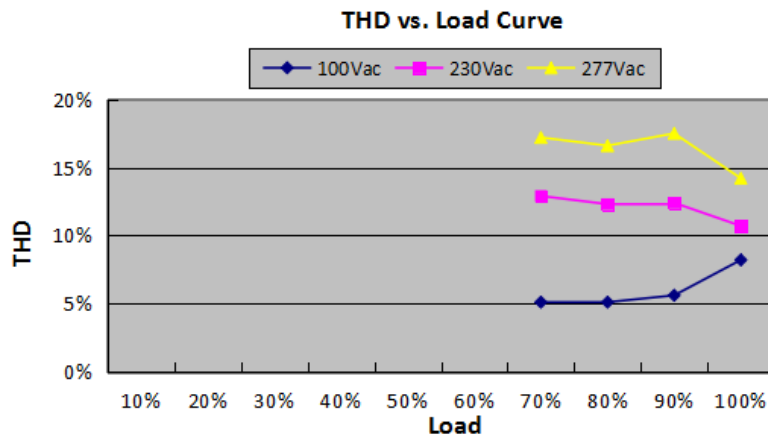

Life vs. Tc 寿命和温度

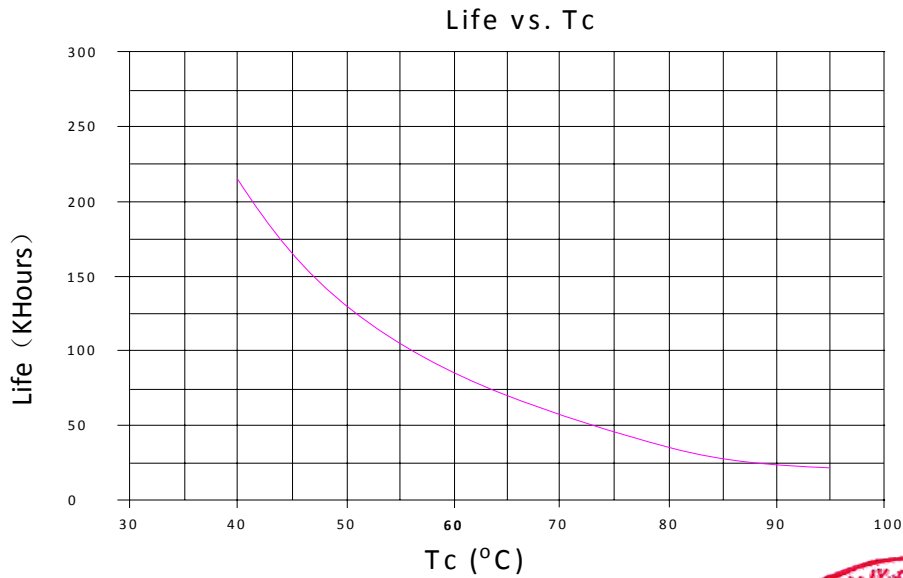

Dimensional Drawing (unit: mm) 尺寸图

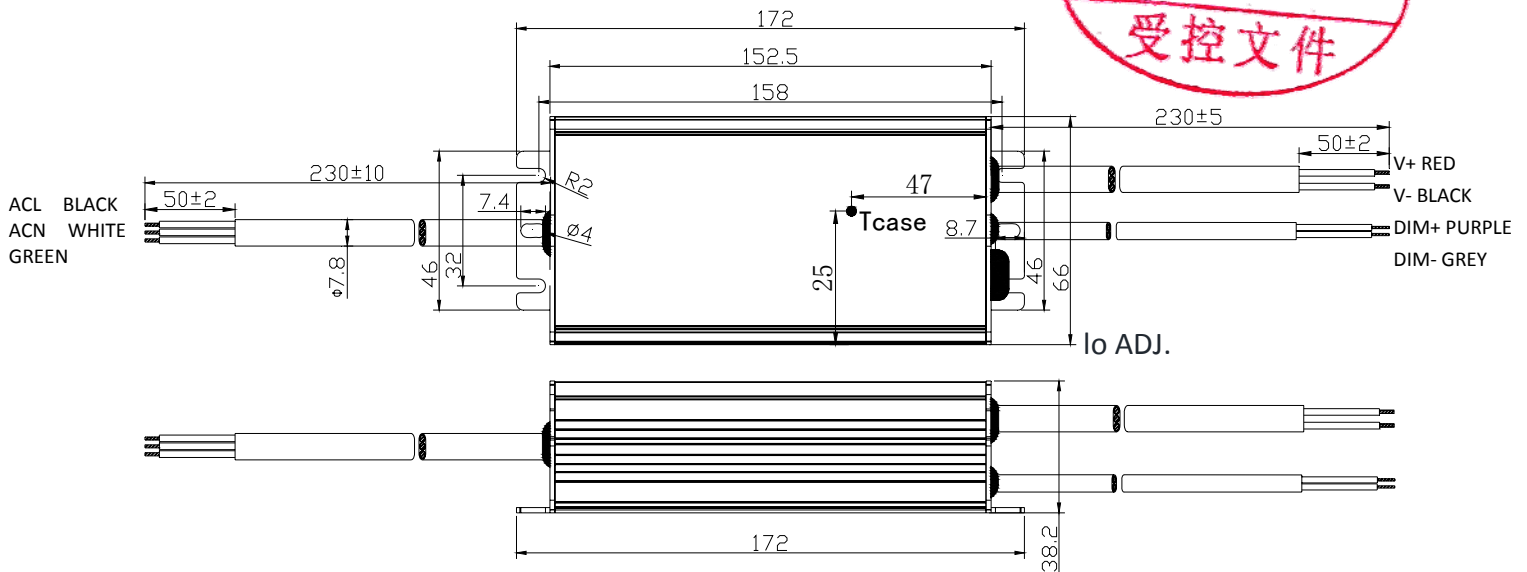

1:AC Power wires: UL SJTW18# 3x0.824MM(OD7.8MM) Black PVC Skin; Triaxial cables with Black, White, Green. Black: L, White: N, Green: GND

1:AC 电源线: UL SJTW18# 3x0.824MM(OD7.8MM)黑色 PVC 外皮, 黑白绿三芯线, 黑 L, 白 N, 绿 GND
 2:DC power wires: UL SJTW18# 2x0.824MM(OD7.8MM) Black PVC Skin; Two cables with black and red, Red LED+, Black LED-.

2:DC 电源线: UL SJTW18# 2x0.824MM(OD7.2MM)黑色 PVC 外皮, 红黑两芯线, 红 LED+, 黑 LED-
 3:Dimming Wires: UL2464(OD6.5MM) 20# Black PVC Skin, Two cables with Purple and Grey, Purple DIM+, Grey DIM-.

3:调光线:UL2464(OD6.5MM)20#黑色 PVC 外皮, 紫灰两芯线, 紫 DIM+, 灰 DIM-

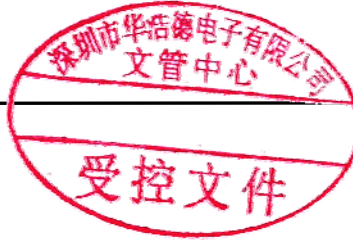

■ LABEL 标签

空位系列标签



www.fahold.com

Constant Current LED Driver
Model: FD-100H-042

OUTPUT

V+ RED

V- BLACK

Io ADJ.

INPUT: 100-240V~ 1.3A 50/60Hz OUTPUT: 30V-42V \approx 1.5-3.0A Max.100W

277V~ 0.5A 50/60Hz •tc

(277VAC for North America only) tc:90°C

Suitable for use in Dry,Damp and Wet Locations ta:60°C











ACL BLACK

ACN WHITE

GREEN

INPUT

OUTPUT

IP67

MADE IN CHINA

B 系列标签



www.fahold.com

Constant Current LED Driver
Model: FD-100H-042B

OUTPUT

V+ RED

V- BLACK

DIM+ PURPLE

DIM- GREY

Io ADJ.

INPUT: 100-240V~ 1.3A 50/60Hz OUTPUT: 30V-42V \approx 1.5-3.0A Max.100W

277V~ 0.5A 50/60Hz •tc

(277VAC for North America only) tc:90°C

Suitable for use in Dry,Damp and Wet Locations ta:60°C











ACL BLACK

ACN WHITE

GREEN

INPUT

OUTPUT

IP67

MADE IN CHINA

C 系列标签



www.fahold.com

Constant Current LED Driver
Model: FD-100H-042C-YYYY

OUTPUT

V+ RED

V- BLACK

INPUT: 100-240V~ 1.3A 50/60Hz OUTPUT: 30V-42V \approx 1.5-3.0A Max.100W

277V~ 0.5A 50/60Hz •tc

(277VAC for North America only) tc:90°C

Suitable for use in Dry,Damp and Wet Locations ta:60°C











ACL BLACK

ACN WHITE

GREEN

INPUT

OUTPUT

IP67

MADE IN CHINA

D 系列标签



www.fahold.com

Constant Current LED Driver
Model: FD-100H-042D-YYYY

OUTPUT

V+ RED

V- BLACK

DIM+ PURPLE

DIM- GREY

INPUT: 100-240V~ 1.3A 50/60Hz OUTPUT: 30V-42V \approx 1.5-3.0A Max.100W

277V~ 0.5A 50/60Hz •tc

(277VAC for North America only) tc:90°C

Suitable for use in Dry,Damp and Wet Locations ta:60°C











ACL BLACK

ACN WHITE

GREEN

INPUT

OUTPUT

IP67

MADE IN CHINA

Remark: Label Was Checked According to Order Current Required

备注: 标签根据订单电流勾选

Tel: 0755-2763 9266、2738 8980 Fax: 0755-2763 9269
www.fahold.com

第 8 页 共 9 页

安装注意事项 Installation considerations

1. 若产品有外部可调电位器，请在调整好电流之后，建议用 704 硅胶将调整电流的孔密封好，将防水胶塞盖好。

If the power supply has adjustable external potentiometer, after adjust output current, suggest using 704 silicone sealing good the hole and plug waterproof rubber.

2. 电源的防雷等级满足 IEC61000-4-5 等各国的标准要求，如果使用在雷电多发地区或电网环境相对复杂的地区，建议在电源的 AC 输入端加装专业的防雷模块。

Lightning protection level to meeting IEC61000-4-5 standard requirement, if you use the lightning occurs or the area of power grid environment is relatively complex, suggest in the power supply of the AC input terminal equipped with professional lightning protection module.

包装, 运输, 贮存 Package, Transportation & Storage

1. 包装 Package

a. 包装箱的外形尺寸为 (单位: mm): 长 X 宽 X 高=420X220X195;

package box outside dimension: L×W×H =420×220×195 (unit: mm);

b. 每箱产品的包装数量为 20 台;

product number in each box: 20PCS;

c. 整箱毛重 KG

whole box gross weight: kg;

2. 运输 Transportation

适用于车, 船, 飞机运输, 运输中应遮蓬, 防晒, 文明装卸。

Packaging is designed suitable for transportation by truck, ship, and plane. The products should be shielded from sunshine, and loaded and unloaded carefully.

3. 贮存 Storage

产品贮存应符合 GB3873-83 的规定。

贮存期限超过一年的产品要重新检验, 合格后方可使用。

The product storage meet the standard of the GB 3873-83.

Product should be rechecked over 1 year.

