



Product Data Sheet

PN:5054FV37UV40WC



5050SMD LED-1W 370nm+400nm LED



ATTENTION

OBSERVE PRECAUTIONS FOR HANDLING
ELECTROSTATIC DISCHARGE
SENSITIVE DEVICES

Features

- Dimensions:5.0mm×5.0mm×H3.5mm
- Color :Purple LED
- Lens: Yellow Diffused Epoxy
- Chip Material:InGaN
- Chip Dimension:550um*875um
- Number of Chips:2pcs
- High reliability,High radiant intensity
- Low forward voltage
- Meet ROHS, Green Product

Applications

- Ideal for backlight
- Medical appliances
- Indicator Light

Package Dimensions

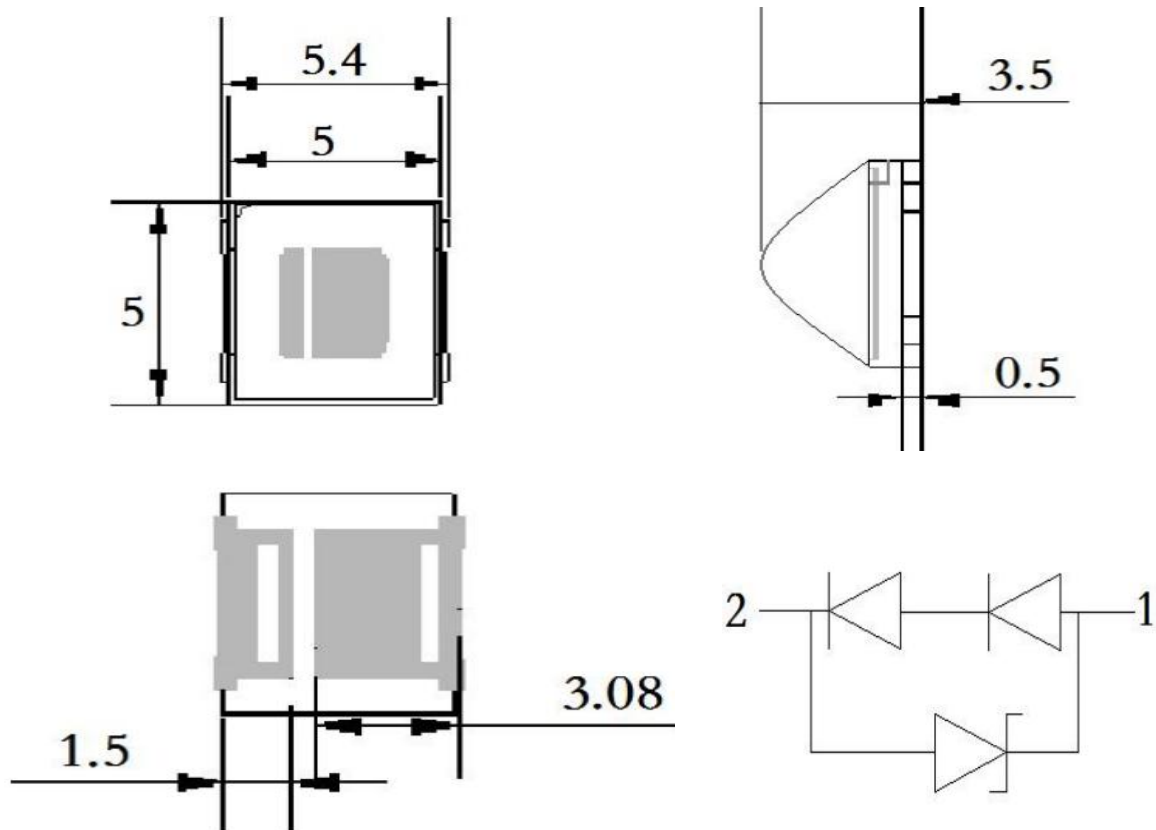

Notes:

- 1.All dimensions are in millimeters ;
- 2.Tolerance is ± 0.10 mm unless otherwise noted.
- 3.The mark is Cathode.

Absolute Maximum Ratings (Tc=25°C)

| Parameter | Symbol | Rating | Unit |
|--------------------------------------|--------|------------|-------|
| Power Dissipation | Pd | 1000 | mW |
| Pulse Forward Current | IFP | 200 | mA |
| Forward Current | IF | ≤150 | mA |
| Reverse Voltage | VR | 5 | V |
| Junction Temperature | Tj | 100 | °C |
| Operating Temperature | Topr | -40 ~ +80 | °C |
| Storage Temperature Range | Tstg | -40 ~ +100 | °C |
| Soldering Temperature | Tsol | 245 | °C |
| Electro-Static-Discharge(HBM) | ESD | 1000 | V |
| Service life under normal conditions | Time | 60000 | H |
| Warranty | Time | 2 | Years |
| Antistatic bag | Piece | 1000 | Bag |

*Pulse Forward Current Condition:Duty 1% and Pulse Width=10us.

*Soldering Condition:Soldering condition must be completed with 3 seconds at 260°C

Electrical Optical Characteristics(Tc=25°C)

| Parameter | Symbol | Min | Typ | Max | Unit | Test Condition |
|-----------------|--------|-----|-----|-----|------|----------------|
| Forward Voltage | VF | 6.5 | 7.0 | 7.5 | V | IF=150mA |
| Luminous Power | PO | 200 | | 300 | mw | IF=150mA |
| Peak Wavelength | λP | 365 | 370 | 375 | nm | IF=150mA |
| | | 395 | 400 | | | |
| Half Width | Δλ | | 60 | | nm | IF=150mA |
| Viewing Angle | 2θ1/2 | | 70 | | deg | IF=150mA |
| Reverse Current | IR | | | 5 | uA | VR=5V |

*Luminous Intensity is measured by ZWL600.

*θ1/2 is the off-axis angle at which the luminous intensity is half the axial luminous intensity.

Bin code definition● **IV Rank@IF=150mA**

| Rank | Min | Max | Unit |
|------|-----|-----|------|
| IV | 200 | 300 | mw |

● **VF Rank@IF=150mA**

| Rank | Min | Max | Unit |
|------|-----|-----|------|
| VF | 6.5 | 7.0 | V |
| | 7.0 | 7.5 | |

● **Wp@IF=150mA**

| Rank | Min | Max | Unit |
|------|-----|-----|------|
| Wp | 365 | 370 | V |
| | 370 | 375 | |
| | 395 | 400 | V |

Typical Electrical-Optical Characteristics Curves

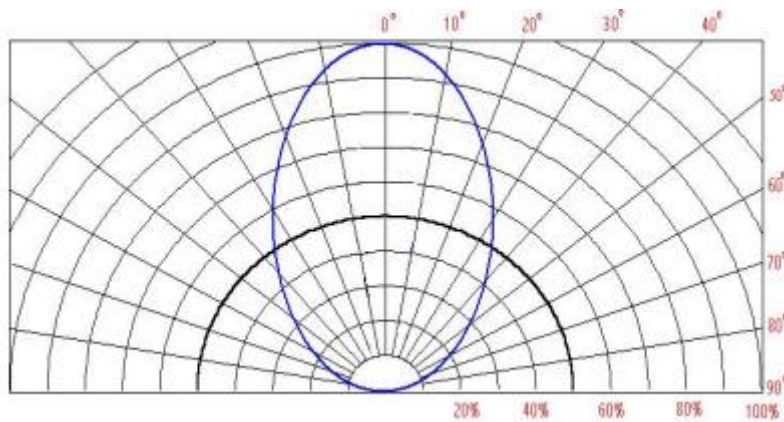
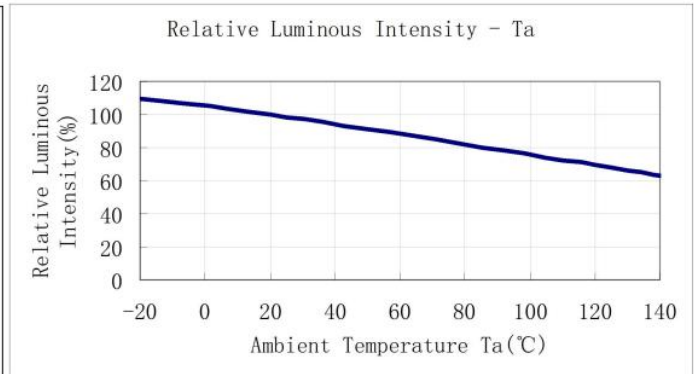
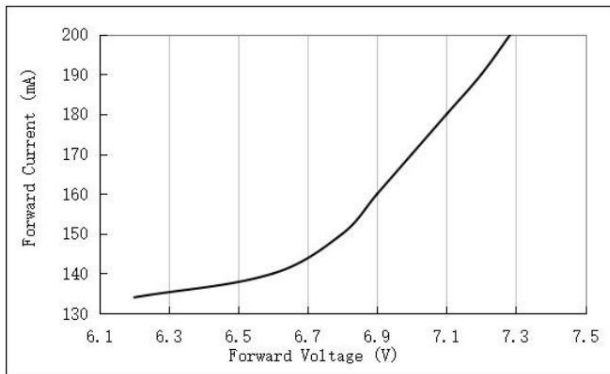
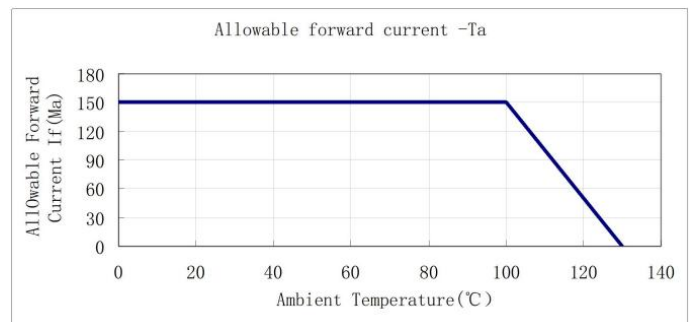
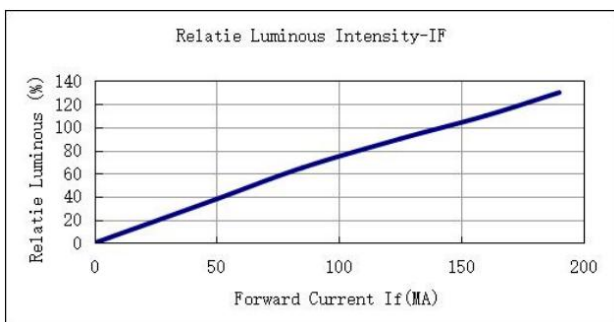
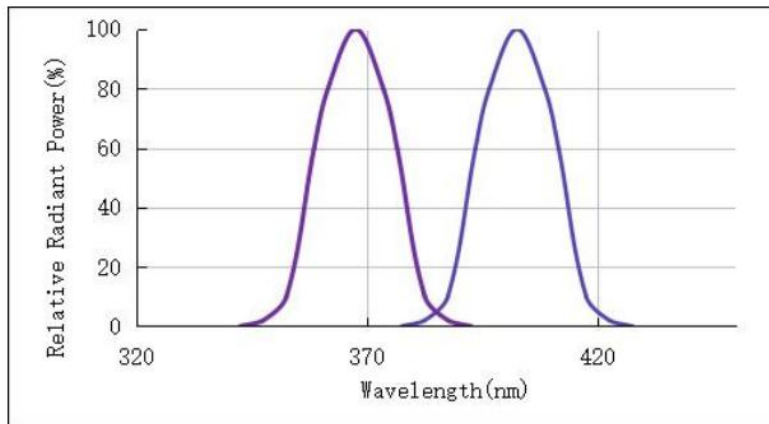

Tape specifications (Units:mm)

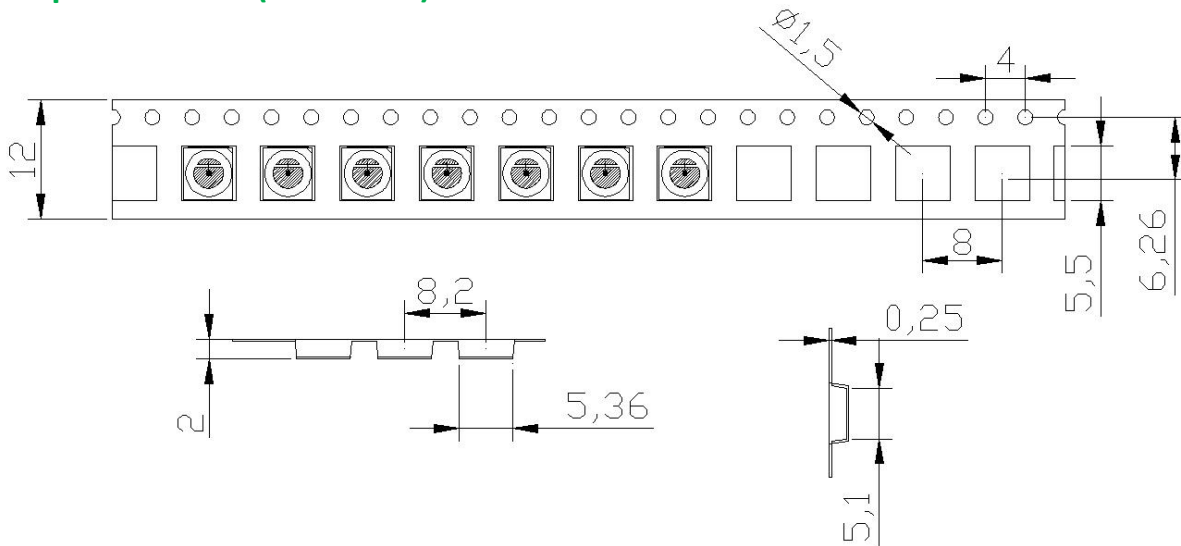

Reel Dimensions

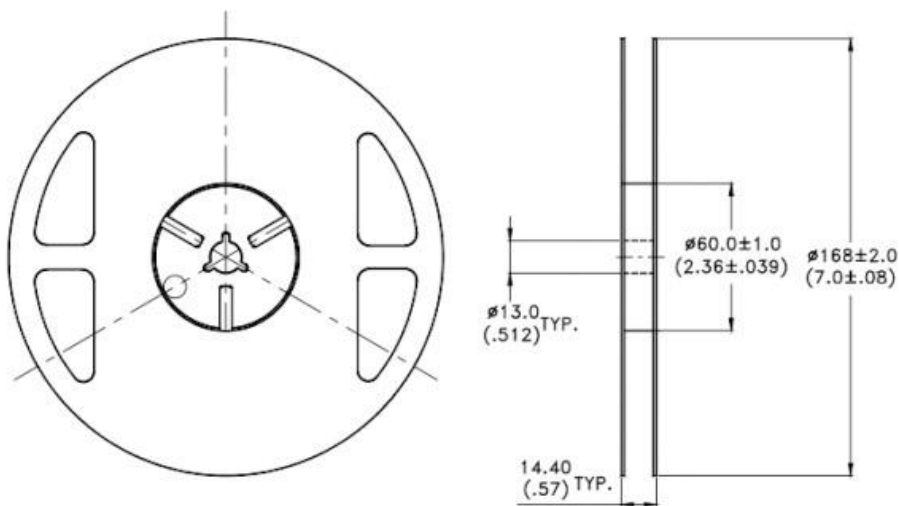

Notes:

1. Empty component pockets sealed with top cover tape.
2. 6.6 inch reel-1000 pieces per reel.

Moisture Resistant Packaging

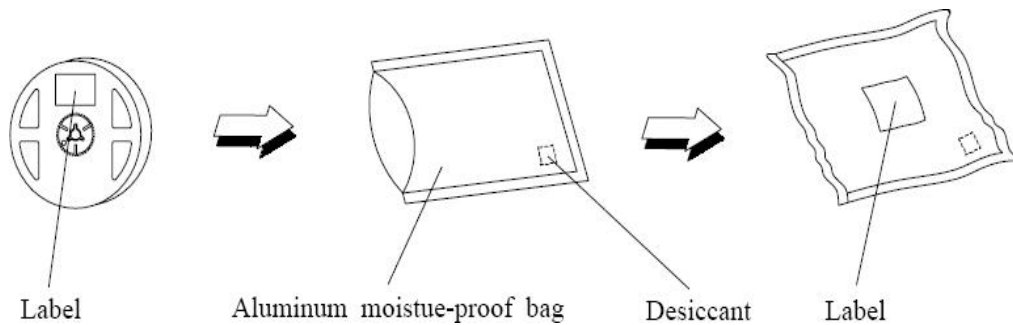

Reliability Test Items and Conditions

| Test Item | Reference | Test Conditions | Time | Quantity | Criterion |
|--|---------------------------|---|-----------|----------|-----------|
| Thermal Shock | JIS-C7021 A-4 | 100°C±5°C 15min ↓ ↑ -40°C±5°C 15min | 200cycles | 22 | 0/22 |
| High Temperature Storage | JEITA ED- 4701 200 201 | Ta=100°C | 1000h | 22 | 0/22 |
| Low Temperature Storage | JEITA ED- 4701 200 202 | Ta=-40°C | 1000h | 22 | 0/22 |
| High Temperature High Humidity Storage | JIS-C7021 B-11 | Ta=85°C, RH=85% | 1000h | 22 | 0/22 |
| Resistance to Soldering Heat | GB/T 4937 | Tsol*=(245±5)°C 10secs. | 2times | 22 | 0/22 |
| Life Test | JESD22-A108 | Ta=25°C±5°C IF=5mA | 1000h | 22 | 0/22 |
| High Temperature Life Test | JESD22-A108 | Ts=55°C±5°C | 1000h | 22 | 0/22 |

*Note:Tsol-Temperature of tin liquid

Criteria for Judging the Damage

| Item | Symbol | Test Condition | Failure Criteria | |
|--------------------|----------|----------------|------------------|-----------|
| | | | MIN | MAX |
| Forward Voltage | VF (V) | IF=150mA | --- | U.S.L*1.1 |
| Reverse Current | IR (uA) | VR=5V | --- | 5uA |
| Luminous Intensity | IV (mcd) | IF=150mA | L.S.L*0.7 | --- |

*Note:1.USL:Upper Specification Level

2.LSL:Lower Specification Level

Reflow soldering profile for LEAD-FREE SMD process

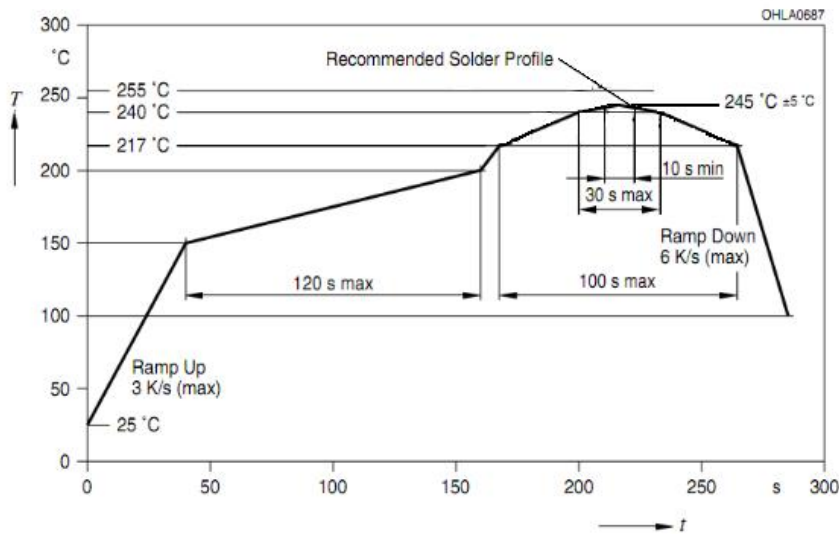

Notes:

1. Don't cause stress to the LEDs while it is exposed to high temperature.
2. The maximum number of reflow soldering passes is 2 times
3. Reflow soldering is recommended. Other soldering methods are not recommended as they might cause damage to the product

Soldering Iron

When hand soldering, keep the temperature of iron below less 300°C less than 3 seconds
The hand solder should be done only one times

Repairing

Repair should not be done after the LEDS have been soldered. When repairing is unavoidable, a double-head soldering iron should be used (as below figure). It should be confirmed in advance whether the characteristics of LEDS will or will not be damaged by repairing.

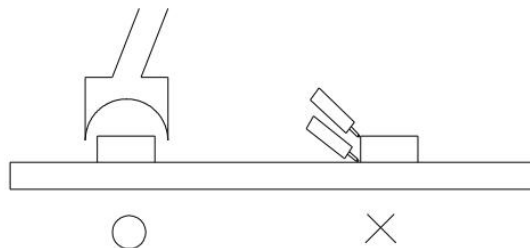

Handling Precautions

Compare to epoxy encapsulant that is hard and brittle, silicone is softer and flexible. Although its characteristic significantly reduces thermal stress, it is more susceptible to damage by external mechanical force. As a result, special handling precautions need to be observed during assembly using silicone encapsulated LED products. Failure to comply might lead to damage and premature failure of the LED.

1. Handle the component along the side surfaces by using forceps or appropriate tools.



2. Do not directly touch or handle the silicone lens surface. It may damage the internal circuitry.

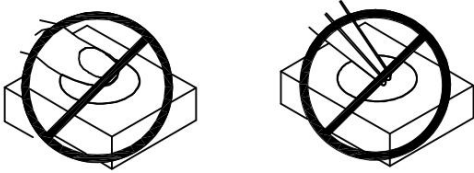

3. Do not stack together assembled PCBs containing exposed LEDs. Impact may scratch the silicone lens or damage the internal circuitry.



- 4.

4-A The inner diameter of the SMD pickup nozzle should not exceed the size of the LED to prevent air leaks

4-B A pliable material is suggested for the nozzle tip to avoid scratching or damaging the LED surface during pickup

4-C The dimensions of the component must be accurately programmed in the pick-and-place machine to insure precise pickup and avoid damage during production

4-D As silicone encapsulation is permeable to gases, some corrosive substances such as H₂S might corrode silver plating of leadframe. Special care should be taken if an LED with Silicone encapsulation is to be used near such substances.

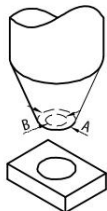

5. LED operating environment and sulfur element composition cannot be over 100PPM in the LED mating usage material.

6. When we need to use external glue for LED application products, please make sure that the external glue matches the LED packaging glue. Additionally, as most of LED packaging glue is silica gel, and it has strong Oxygen permeability as well as strong moisture permeability; in order to prevent external of Bromine element is required to be less than

900PPM,the single content of Chlorine element is required to be less than 900PPM,the total content of Bromine element and Chlorine element in the external glue of the application products is required to be less than 1500PPM

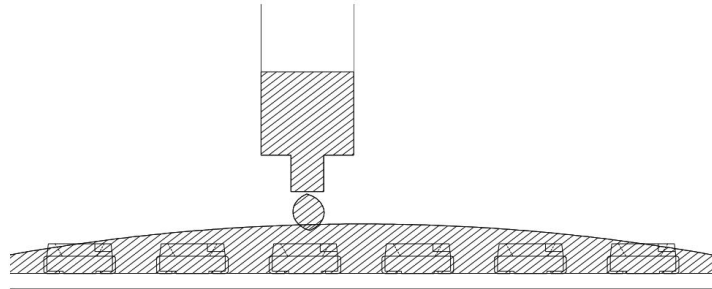

7. Avoid continued exposure to the condensing moisture environment and keep the product away from rapid transitions in ambient temperature.

Storage

1. Do not open moisture proof bag before the products are ready to use.
2. The storage conditions of sealed bags are: TA 5℃ - 30℃, RH < 60%.
3. The storage time is calculated according to the date of the certificate on the packaging bag, and the effective time is 30 days. If the time is more than 30 days, it must be baked before use, and the baking condition is 65℃ / 24h.
4. Before opening the package, please check the vacuum bag for find air leak in time. If so, please use it after baking.
5. After opening, please use the product under the following conditions: temperature < 30 ℃ / Rh < 60%. in addition, Please following baking treatment as below before use:
A: Baking condition: Place the product in an oven at 65 ℃ (± 5 ℃) for 24 hours.
B: Take out the product from the packaging bag and bake it. Do not open the oven during baking.
6. In order to avoid the customer's loss in the production process that caused by moisture absorption of materials, please Strictly observe with the above requirements.