



# Product Data Sheet

PN:1010-3-03-RGBW



---

1010SMD LED-RGB LED



## ATTENTION

OBSERVE PRECAUTIONS FOR HANDLING  
ELECTROSTATIC DISCHARGE  
SENSITIVE DEVICES

## Features

- Dimensions:1.0mm×1.0mm×H0.9mm
- Color :RGB LED
- Lens: White Diffused Epoxy
- Chip Material:InGaN、 InGaN、 AlGaAs
- Chip Dimension:205um、 205um、 205um
- Number of Chips:3pcs
- High reliability,High radiant intensity
- Low forward voltage
- Meet ROHS, Green Product

## Applications

Ideal for backlight  
Medical appliances  
Indicator Light

## Package Dimensions

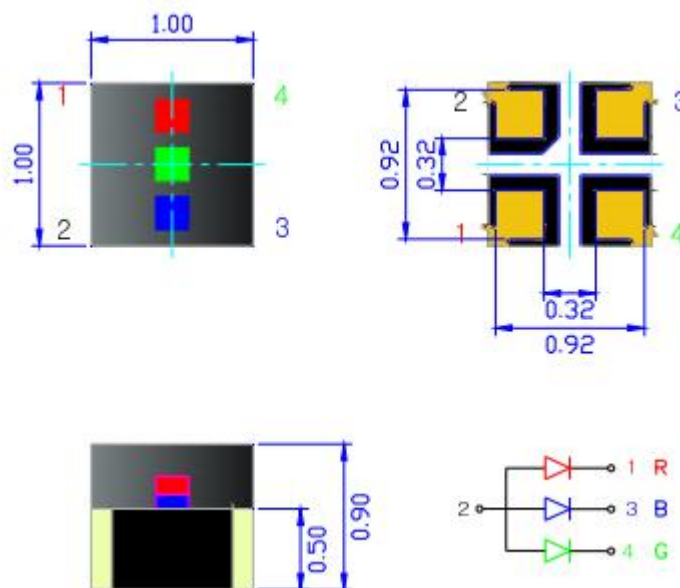

Notes:

- 1.All dimensions are in millimeters ;
- 2.Tolerance is  $\pm 0.10$  mm unless otherwise noted.
- 3.The mark is cathode.

## Absolute Maximum Ratings (Tc=25°C)

Parameter	Symbol	Rating			Unit
		Red	Green	Blue	
Power Dissipation	Pd	60	100	100	mW
Pulse Forward Current	IFP	100	100	100	mA
Forward Current	IF	30	30	30	mA
Reverse Voltage	VR	5			V
Junction Temperature	Tj	100			°C
Operating Temperature	Topr	-40 ~ +80			°C
Storage Temperature Range	Tstg	245			°C
Soldering Temperature	Tsol	260			°C
Electro-Static-Discharge(HBM)	ESD	1000			V
Service life under normal conditions	Time	50000			H
Warranty	Time	1			Years
Antistatic bag	Piece	21000pcs			Bag

\*Pulse Forward Current Condition:Duty 1% and Pulse Width=10us.

\*Soldering Condition:Soldering condition must be completed with 3 seconds at 260°C

## Electrical Optical Characteristics(Tc=25°C)

Parameter	Symbol	Min	Typ	Max	Unit	Test Condition
Forward Voltage	Red	1.8	2.0	2.4	V	IF=8mA
	Green	2.8	3.0	3.4		IF=5mA
	Blue	2.8	3.0	3.4		IF=3mA
Luminous Intensity	Red	28		35	mcd	IF=8mA
	Green	75		94		IF=5mA
	Blue	8		10		IF=3mA
Dominant Wavelength	Red	618	620	623	nm	IF=8mA
	Green	510	520	530		IF=5mA
	Blue	460	465	475		IF=3mA
Half Width	$\Delta\lambda$		15		nm	IF=20mA
Viewing Half Angle	$2\theta_{1/2}$		120		deg	IF=20mA
Reverse Current	IR			0.5	uA	VR=12V

\*Luminous Intensity is measured by ZWL600.

\* $\theta_{1/2}$  is the off-axis angle at which the luminous intensity is half the axial luminous intensity.

## Typical Electrical-Optical Characteristics Curves

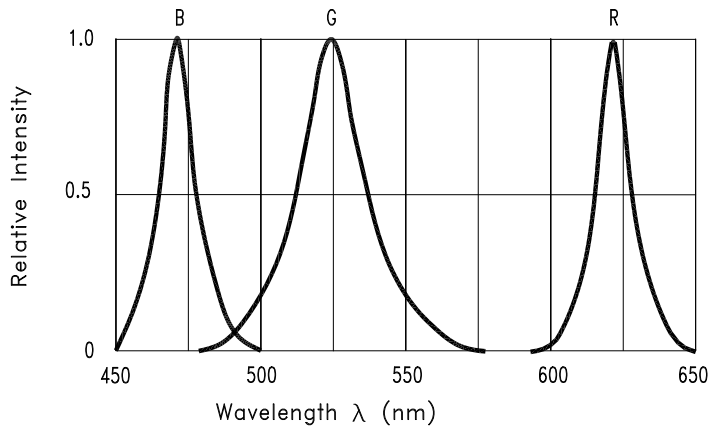

Fig.1 RELATIVE INTENSITY VS. WAVELENGTH

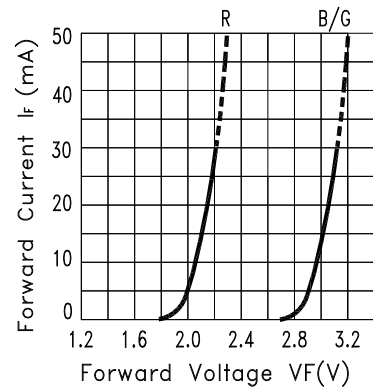

Fig.2 FORWARD CURRENT VS. FORWARD VOLTAGE

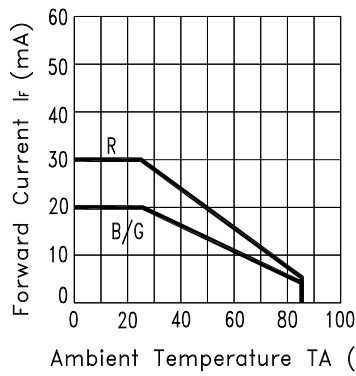

Fig.3 FORWARD CURRENT DERATING CURVE

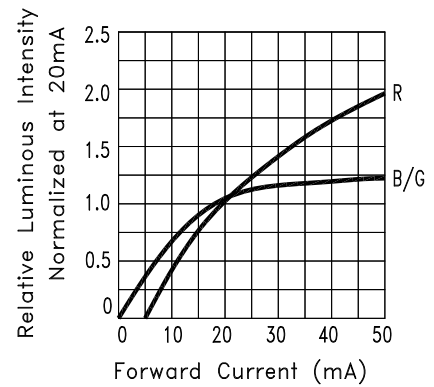

Fig.4 RELATIVE LUMINOUS INTENSITY VS. FORWARD CURRENT

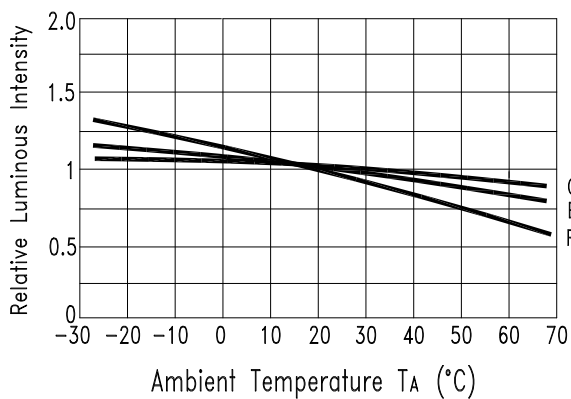

Fig.5 Luminous Intensity vs. Ambient Temperature

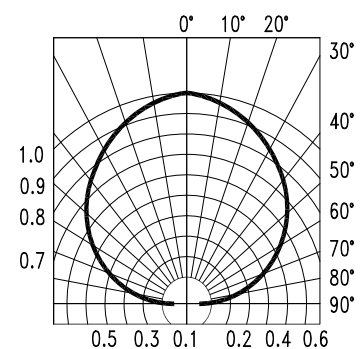
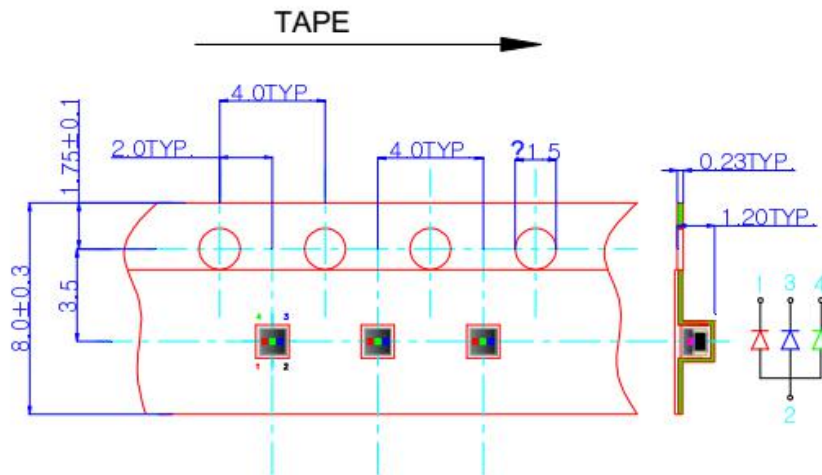
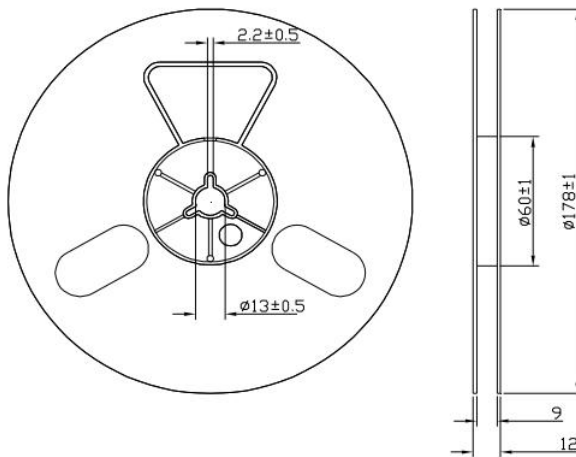

Fig.6 SPATIAL DISTRIBUTION

## Tape specifications (Units:mm)



## Reel Dimensions



### Notes:

1. Empty component pockets sealed with top cover tape.
2. 6.6 inch reel-21000 pieces per reel.

## Moisture Resistant Packaging

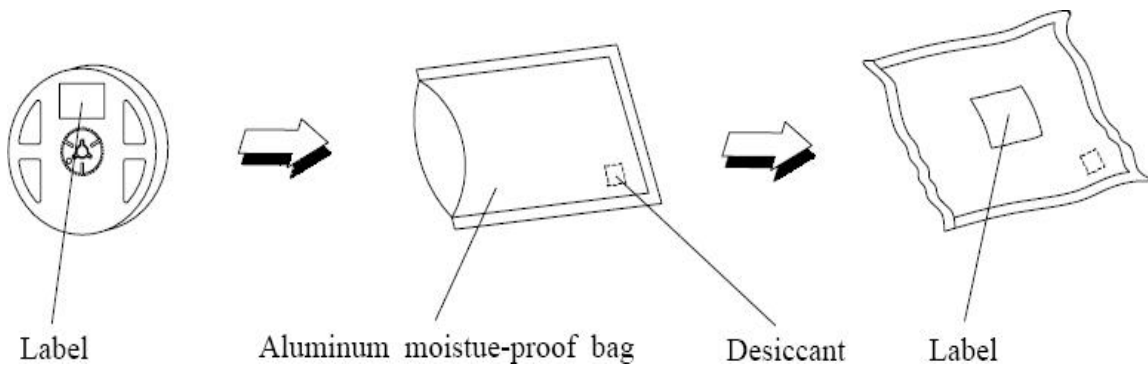

## Reliability Test Items and Conditions

Test Item	Reference	Test Conditions	Time	Quantity	Criterion
Thermal Shock	JIS-C7021 A-4	100°C±5°C 15min ↓ ↑ -40°C±5°C 15min	200cycles	22	0/22
High Temperature Storage	JEITA ED- 4701 200 201	Ta=100°C	1000h	22	0/22
Low Temperature Storage	JEITA ED- 4701 200 202	Ta=-40°C	1000h	22	0/22
High Temperature High Humidity Storage	JIS-C7021 B-11	Ta=85°C, RH=85%	1000h	22	0/22
Resistance to Soldering Heat	GB/T 4937	Tsol*=(260±5)°C 10secs.	2times	22	0/22
Life Test	JESD22-A108	Ta=25°C±5°C IF=5mA	1000h	22	0/22
High Temperature Life Test	JESD22-A108	Ts=55°C±5°C	1000h	22	0/22

\*Note:Tsol-Temperature of tin liquid

## Criteria for Judging the Damage

Item	Symbol	Test Condition	Failure Criteria	
			MIN	MAX
Forward Voltage	VF (V)	IF=20mA	---	U.S.L*1.1
Reverse Current	IR (uA)	VR=5V	---	5uA
Luminous Intensity	IV (mcd)	IF=20mA	L.S.L*0.7	---

\*Note:1.USL:Upper Specification Level

2.LSL:Lower Specification Level

**Suggest Soldering Pad Dimensions**

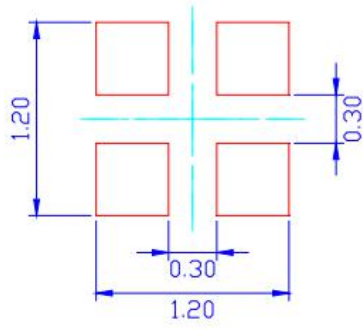

## Reflow soldering profile for LEAD-FREE SMD process

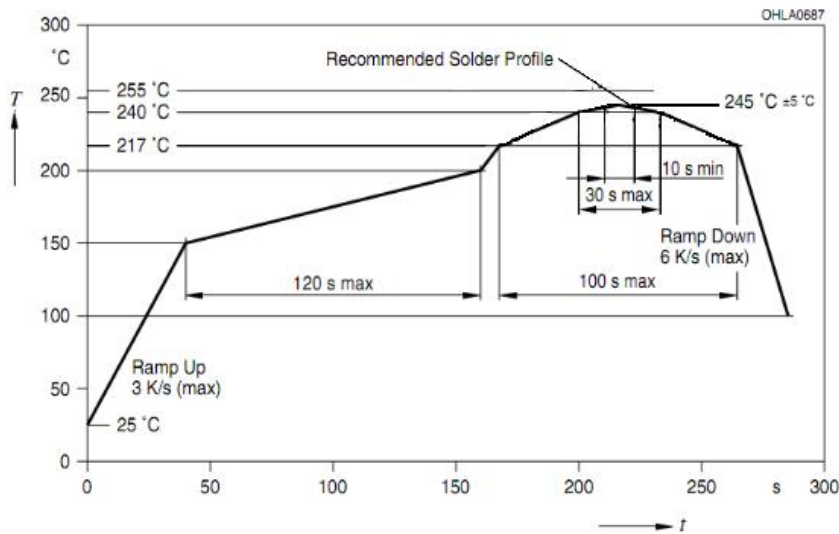

### Notes:

1. Don't cause stress to the LEDs while it is exposed to high temperature.
2. The maximum number of reflow soldering passes is 2 times
3. Reflow soldering is recommended. Other soldering methods are not recommended as they might cause damage to the product

## Soldering Iron

When hand soldering, keep the temperature of iron below less 300°C less than 3 seconds

The hand solder should be done only one times

## Repairing

Repair should not be done after the LEDS have been soldered. When repairing is unavoidable, a double-head soldering iron should be used (as below figure). It should be confirmed in advance whether the characteristics of LEDS will or will not be damaged by repairing.

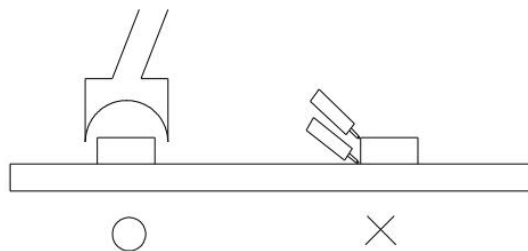



## HANDLING PRECAUTIONS

Compare to epoxy encapsulant that is hard and brittle, silicone is softer and flexible. Although its characteristic significantly reduces thermal stress, it is more susceptible to damage by external mechanical force. As a result, special handling precautions need to be observed during assembly using silicone encapsulated LED products. Failure to comply might lead to damage and premature failure of the LED.

1. Handle the component along the side surfaces by using forceps or appropriate tools.



2. Do not directly touch or handle the silicone lens surface. It may damage the internal circuitry.

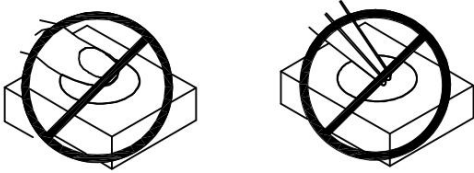

3. Do not stack together assembled PCBs containing exposed LEDs. Impact may scratch the silicone lens or damage the internal circuitry.



4. 4-A The inner diameter of the SMD pickup nozzle should not exceed the size of the LED to prevent air leaks  
4-B A pliable material is suggested for the nozzle tip to avoid scratching or damaging the LED surface during pickup

4-C The dimensions of the component must be accurately programmed in the pick-and-place machine to insure precise pickup and avoid damage during production

4-D As silicone encapsulation is permeable to gases, some corrosive substances such as H<sub>2</sub>S might corrode silver plating of leadframe. Special care should be taken if an LED with Silicone encapsulation is to be used near such substances.

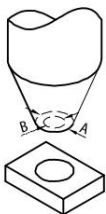

5. LED operating environment and sulfur element composition cannot be over 100PPM in the LED mating usage material.

6. When we need to use external glue for LED application products, please make sure that the external glue matches the LED packaging glue. Additionally, as most of LED packaging glue is silica gel, and it has strong Oxygen permeability as well as strong moisture permeability; in order to prevent external of Bromine element is required to be less than 900PPM, the single content of Chlorine element is required to be less than 900PPM, the total content of Bromine element and Chlorine element in the external glue of the application products is required to be less than 1500PPM

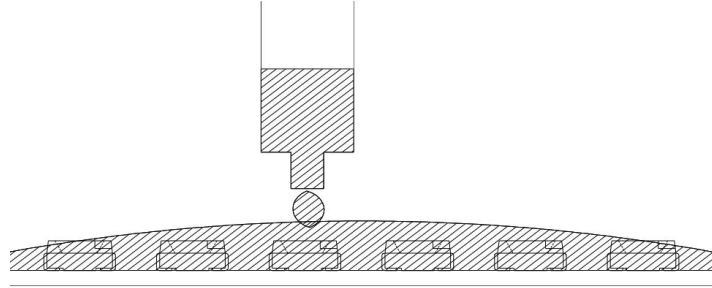

7. Avoid continued exposure to the condensing moisture environment and keep the product away from rapid transitions in ambient temperature.

## Storage

1. Do not open moisture proof bag before the products are ready to use.
2. The storage conditions of sealed bags are: TA 5°C - 30°C, RH < 60%.
3. The storage time is calculated according to the date of the certificate on the packaging bag, and the effective time is 30 days. If the time is more than 30 days, it must be baked before use, and the baking condition is 65°C / 24h.
4. Before opening the package, please check the vacuum bag for find air leak in time. If so, please use it after baking.
5. After opening, please use the product under the following conditions: temperature < 30 °C / Rh < 60%. in addition, Please following baking treatment as below before use:
  - A: Baking condition: Place the product in an oven at 65 °C (± 5 °C) for 24 hours.
  - B: Take out the product from the packaging bag and bake it. Do not open the oven during baking.
6. In order to avoid the customer's loss in the production process that caused by moisture absorption of materials, please Strictly observe with the above requirements.