

HSF

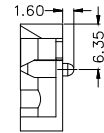

ROHS

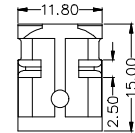
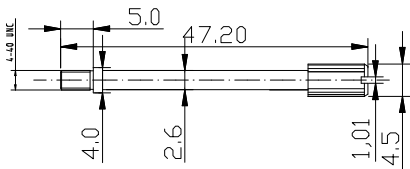
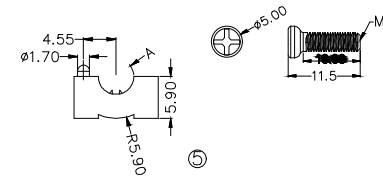
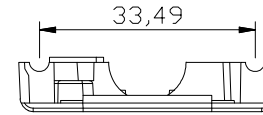
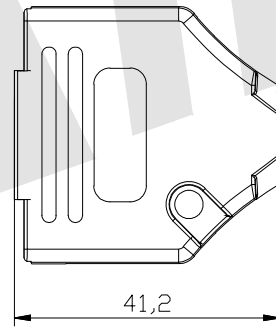
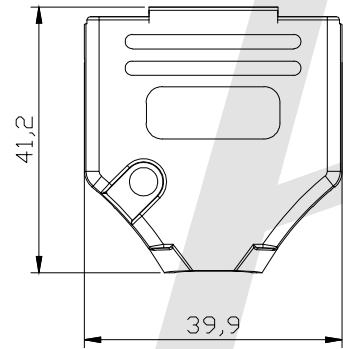
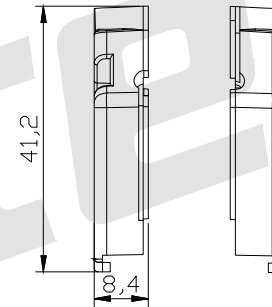
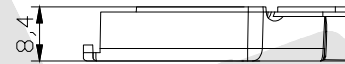
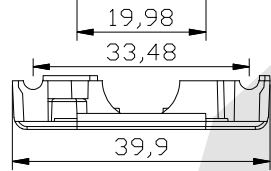
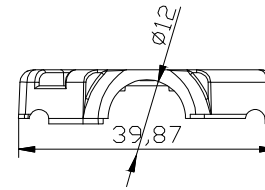
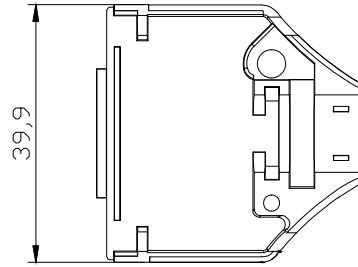
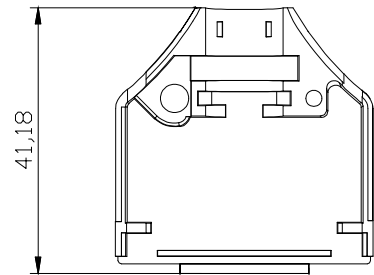

	A
Grommets	$\phi 5.0$
Grommets	$\phi 6.0$
Grommets	$\phi 7.0$
Grommets	$\phi 8.0$
Grommets	$\phi 9.0$
Grommets	$\phi 10.0$

Unless otherwise specified tolerance  
X.  $\pm 0.35$  X.XX:  $\pm 0.20$   
X.X:  $\pm 0.25$  X.XXX:  $\pm 0.15$

SCALE: As Shown UNIT: mm  
DRAW: TMX DATE: 12/09/2021  
CHECK: BobYang DATE: 12/09/2021



NOTES:

Material: zinc alloy  
Finished: chromate plated  
Ordering code:

DBZY - 15 - X - X - 1  $\Delta$   
① ② ③ ④ ⑤

- ① Series No:  
Y type long screw
- ② Contact number:  
15=15PIN
- ③ Cable entry size:  
Dimension of "X"  
 $\Delta$  X=A, See The Table  
5=5mm  
.....  
10=10mm
- ④ Packing type  
1: Mix packing  
2: Separation packing
- ⑤ Series No: 1

Item	Description	Q'TY	Material	Finished
1	Below Shell	1PCS	Zinc alloy	Nickel Plated
2	Up Shell	1PCS	Zinc alloy	Nickel Plated
3	Long Screw	2PCS	Iron	Blue Zinc Plated
4	Short Screw	2PCS	Iron	Blue Zinc Plated
5	Grommets	1SET	ABS	Black

**Antenk**® ANTENK ELECTRONICS CO., LTD  
Http://www.antenk.com  
E-mail: sales@antenk.com

TITLE:  
D-SUB METAL HOODS, 15P, Y TYPE, LONG SCREW

DRAWING NO: DBZY-15XX1

PRODUCT NO: DBZY-15XX1

$\Delta$  Revise Entry Cable Dimension

22/04/2022

$\Delta$  Revise Ordering Code

22/04/2022

REV DESCRIPTION

DATE