

NOTES:

- Interface meets mini-B USB specification
- Electrical Specifications:
Meets USB Specifications Revision 2.0
Initial Low level Contact Resistance: 50 mOhm max.
Insulation Resistance 100 MOhm min.
Current Rating: 1.0 A max. at 25. C
DWV: 100 VAC (RMS)/for 60s at sea level
Operating Temperature: -40. C to +85. C
- Material and Finish:
Insulator Material: 30% Glass Filled PBT, UL 94V-0; Oxygen Index: >21%; Color: Black
Shell Material: Phosphor Bronze, 100u" min. Tin over 40u" min. nickel plated
Contact Material: Half -hard Phosphor Bronze,
Contact Finish:
- Mating Area: 30u" min. Gold over 50u" min. Nickel
- Solder Tails: 150u" min. Tin over 50u" min Nickel
- RoHS Compliant

Ordering Code:

NUES05 - X - X - X - X - X
① ② ③ ④ ⑤ ⑥

- ① Series No:
- ② Shell Material:
B:Brass I:Iron
S:stainless steel
- ③ Insulator
Material:
P:PBT+30%GF
L:LCP
- ④ Contact Material:
B:Brass
P:phosphor copper
- ⑤ Contact Plating
G0: Gold flash
G1: 3u" Gold
G2: 5u" Gold
G3: 10u" Gold
G4: 15u" Gold
G5: 30u" Gold
- ⑥ Packing
A:Tray
B:Bag
C:Tube
D:Tape & Reel

PCB LAYOUT

Unless Otherwise specified tolerance
X. ±0.35 X.XX: ±0.20
X.X: ±0.25 X.XXX: ±0.15

SCALE: As Shown	UNIT: mm
DRAW Wu Feng Rong	DATE 08/10/2019
CHECK BobYang	DATE 08/10/2019

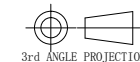

Antenk ANTENK ELECTRONICS CO.,LTD
Http://www.antenk.com
E-mail:sales@antenk.com

TITLE:
MINI USB 5P Female Straight B Type

DRAWING NO: NUES05-XXXXX

PRODUCT NO: NUES05-XXXXX

REV	DESCRIPTION	DATE
-----	-------------	------

HSE  RoHS

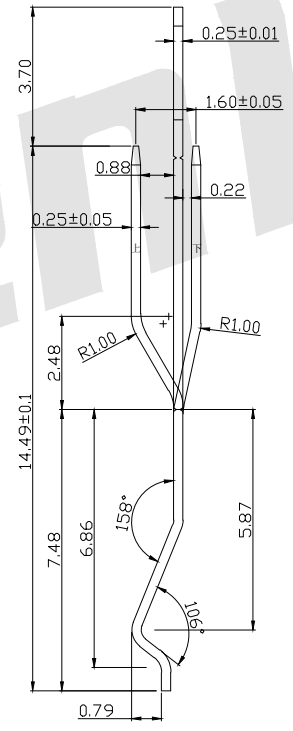
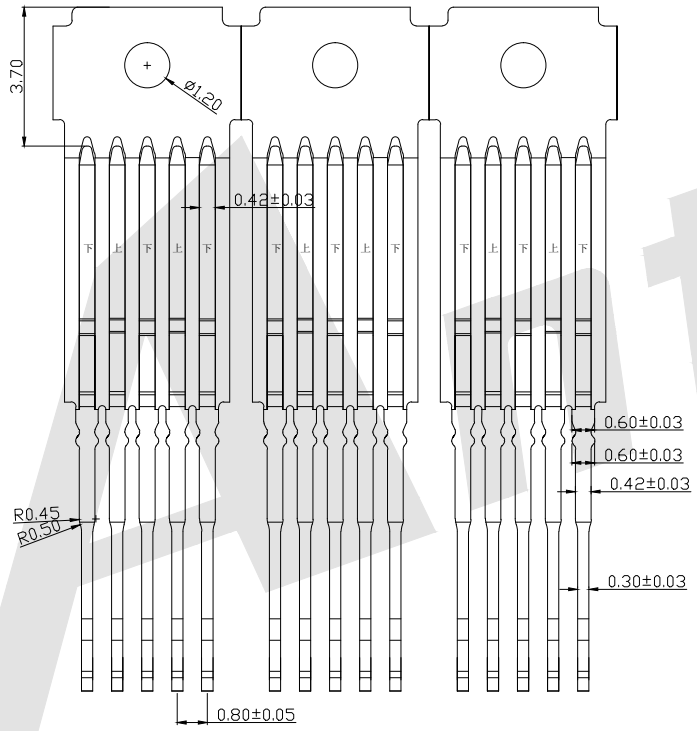

Unless Otherwise specified tolerance	
X. ±0.35	X.XX: ±0.20
X.X: ±0.25	X.XXX: ±0.15
SCALE: As Shown	UNIT: mm
DRAW Wu Feng Rong	DATE 08/10/2019
CHECK BobYang	DATE 08/10/2019

Antenk © ANTENK ELECTRONICS CO., LTD
[Http://www.antenk.com](http://www.antenk.com)
 E-mail:sales@antenk.com

TITLE:
 MINI USB 5P Female Straight B Type Terminal

DRAWING NO: NUF505-XXXX
 PRODUCT NO: NUF505-XXXX

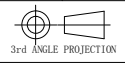

REV	DESCRIPTION	DATE

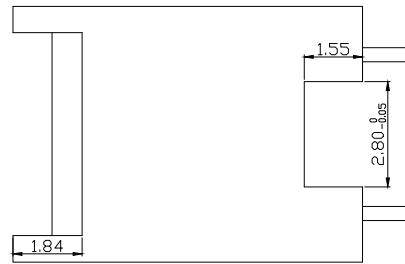
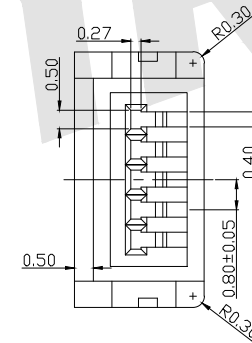
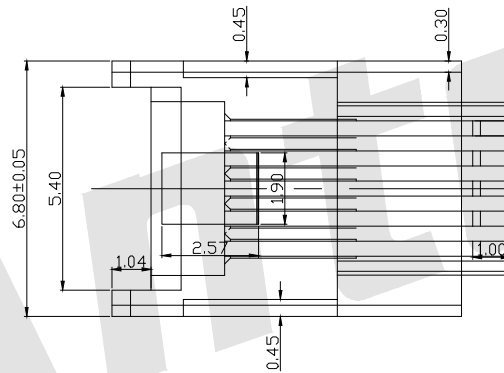
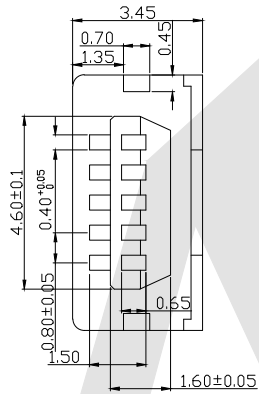
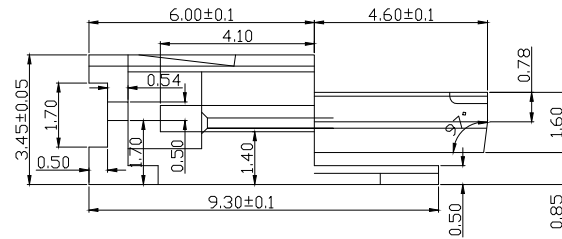

Unless Otherwise specified tolerance
 X. ±0.35 X.XX: ±0.20
 X.X: ±0.25 X.XXX: ±0.15

SCALE: As Shown	UNIT: mm
DRAW Wu Feng Rong	DATE 08/10/2019
CHECK BobYang	DATE 08/10/2019

Antenk © ANTENK ELECTRONICS CO., LTD
[Http://www.antenk.com](http://www.antenk.com)
 E-mail:sales@antenk.com

TITLE:
 MINI USB 5P Female Straight B Type Housing

DRAWING NO: NUF505-XXXXX

PRODUCT NO: NUF505-XXXXX

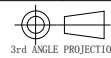

REV	DESCRIPTION	DATE

HSF



RoHS

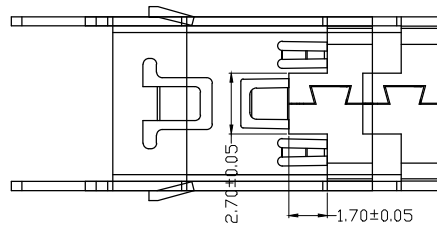
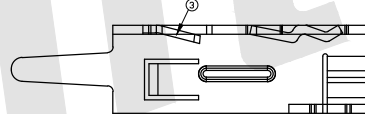
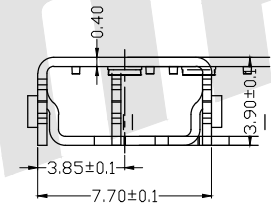
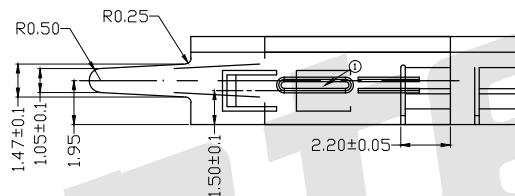
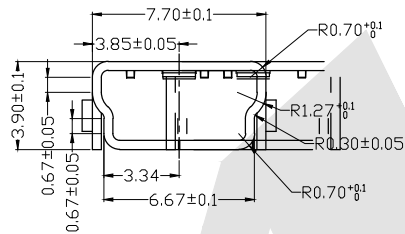
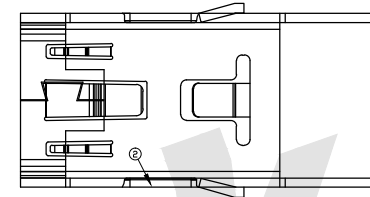
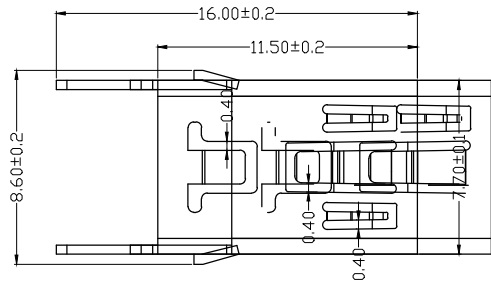

Unless Otherwise specified tolerance
 X. ±0.35 X.XX: ±0.20
 X.X: ±0.25 X.XXX: ±0.15

SCALE: As Shown	UNIT: mm
DRAW Wu Feng Rong	DATE 08/10/2019
CHECK BobYang	DATE 08/10/2019

Antenk © ANTENK ELECTRONICS CO., LTD
[Http://www.antenk.com](http://www.antenk.com)
 E-mail:sales@antenk.com

TITLE:
 MINI USB 5P Female Straight B Type Shell

DRAWING NO: NUFS05-XXXX

PRODUCT NO: NUFS05-XXXX

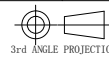

REV	DESCRIPTION	DATE
1		
2		
3		
4		
5		