

### SPECIFICATIONS:

- Voltage rating: 250V AC/DC
- Current rating: 3A AC/DC
- Withstanding Voltage: 1000V AC/minute
- Insulation resistance: 1000MΩ Min.
- Temperature range: -25°C To +85°C
- Contact resistance: 20mΩ Max.

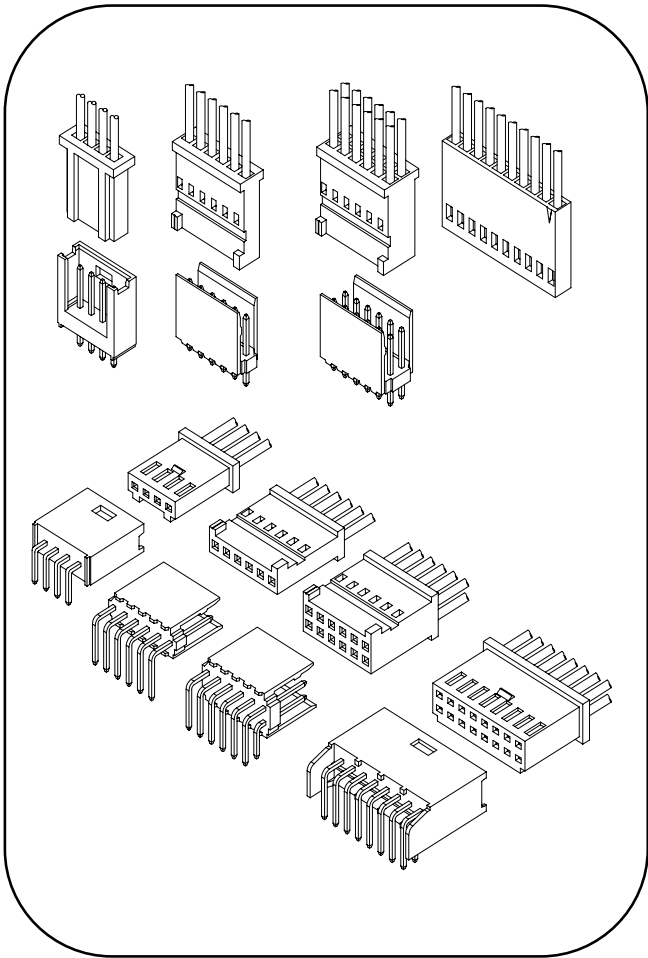

### Standards

HSF



RoHS

Wire to Board

### Assembly Layout

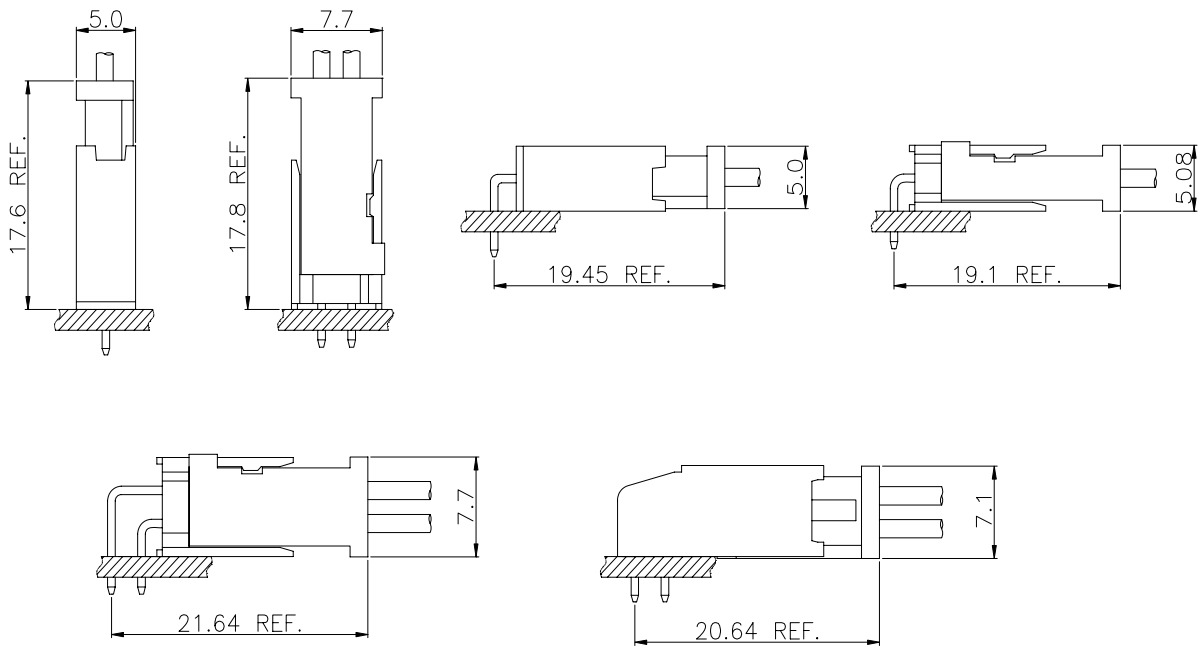

Connectors Expert Around You

## 2.54mm Pitch crimp terminal connector

### TERMINAL

- Part NO.:AT2549T-xP-B
- Applicable wire:AWG#22-#26
- Material:Phosphor Bronze
- Finish:Tin Plated or Gold
- Used in AH2549 AH2549-2 AH2549A series Housing

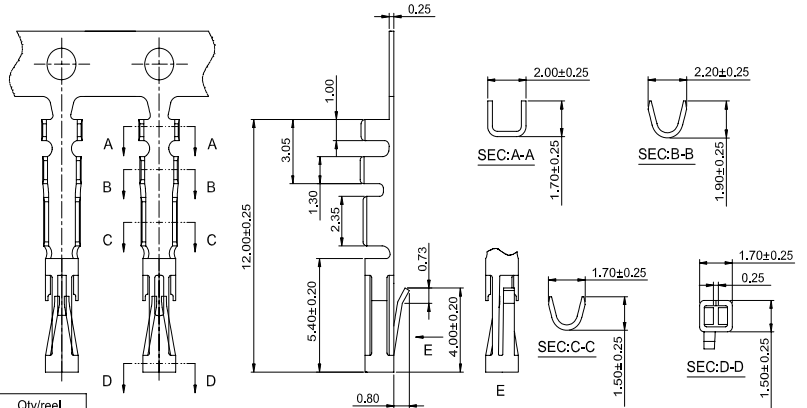

### Ordering information & Specifications

Part NO.	Wire Range	Insulation O.D.	Material	Finish	Qty/reel
AT2549T-TP-B	AWG#22-#26	1.55mm(max)	Phosphor Bronze	Tin over Nickel	15,000 PCS
AT2549T-GP-B	AWG#22-#26	1.55mm(max)	Phosphor Bronze	Gold over Nickel	15,000 PCS

Wire to Board

## 2.54mm Pitch crimp terminal connector

### TERMINAL

- Part NO.:AT2549T-xP-C
- Applicable wire:AWG#22-#26
- Material:Phosphor Bronze
- Finish:Tin Plated or Gold
- Used in AH2549C AH2549C-2 AH2549D AH2549D-2 AH2549E-2 AH2549G-2 AH2549L-2 series Housing

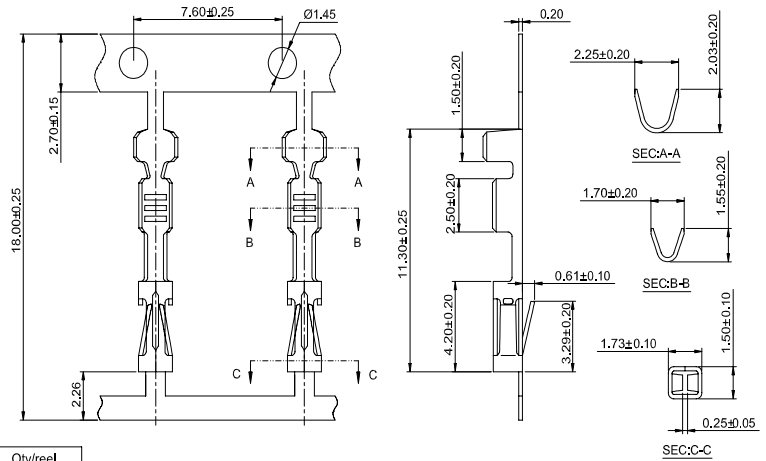

### Ordering information & Specifications

Part NO.	Wire Range	Insulation O.D.	Material	Finish	Qty/reel
AT2549T-TP-C	AWG#22-#26	1.55mm(max)	Phosphor Bronze	Tin over Nickel	15,000 PCS
AT2549T-GP-C	AWG#22-#26	1.55mm(max)	Phosphor Bronze	Gold over Nickel	15,000 PCS

## 2.54mm Pitch crimp terminal connector

### TERMINAL

- Part NO.:AT2549T-xP-C-H
- Applicable wire:AWG#20-#24
- Material:Phosphor Bronze
- Finish:Tin Plated or Gold
- Used in AH2549C AH2549C-2 AH2549D AH2549D-2 AH2549E-2 AH2549G-2 AH2549L-2 series Housing

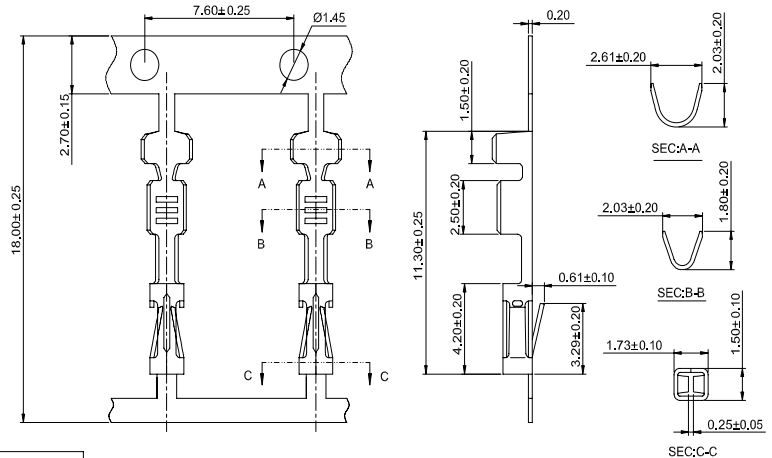

### Ordering information & Specifications

Part NO.	Wire Range	Insulation O.D.	Material	Finish	Qty/reel
AT2549T-TP-C-H	AWG#20-#24	1.90mm(max)	Phosphor Bronze	Tin over Nickel	20,000 PCS
AT2549T-GP-C-H	AWG#20-#24	1.90mm(max)	Phosphor Bronze	Gold over Nickel	20,000 PCS

Connectors Expert Around You

## 2.54mm Pitch crimp terminal connector

### TERMINAL

- Part NO.:AT2549T-xP-C-L
- Applicable wire:AWG#28-#32
- Material:Phosphor Bronze
- Finish:Tin Plated or Gold
- Used in AH2549C AH2549C-2 AH2549D AH2549D-2 AH2549E-2 AH2549G-2 AH2549L-2 series Housing

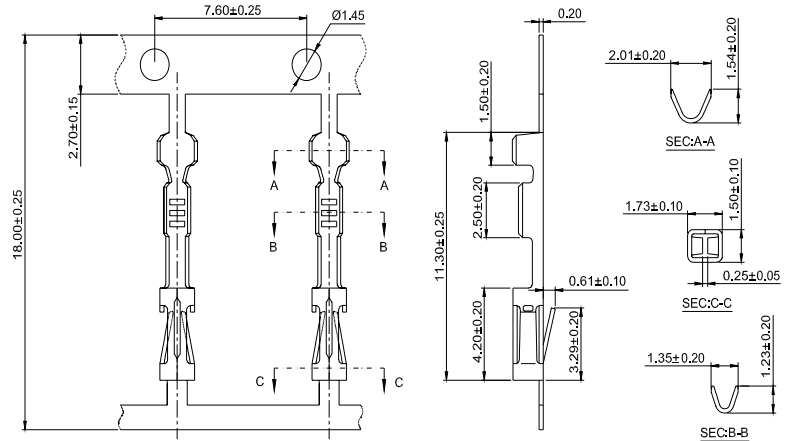

Ordering information & Specifications

Part NO.	Wire Range	Insulation O.D.	Material	Finish	Qty/reel
AT2549T-TP-C-L	AWG#28-#32	0.90mm(max)	Phosphor Bronze	Tin over Nickel	20,000 PCS
AT2549T-GP-C-L	AWG#28-#32	0.90mm(max)	Phosphor Bronze	Gold over Nickel	20,000 PCS

Wire to Board

## 2.54mm Pitch crimp terminal connector

### TERMINAL

- Part NO.:AT2549T-xP-
- Applicable wire:AWG#22-#24
- Material:Phosphor Bronze
- Finish:Tin Plated or Gold
- Used in AH2549I-xP series Housing

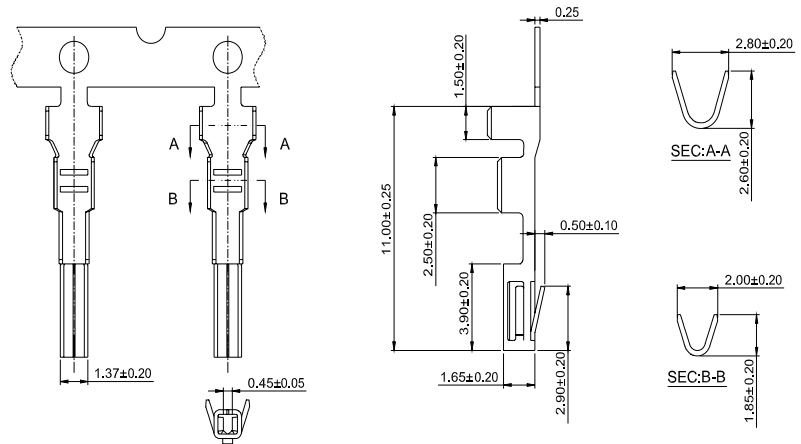

Ordering information & Specifications

Part NO.	Wire Range	Insulation O.D.	Material	Finish	Qty/reel
AT2549T-TP-I	AWG#22-#24	1.55mm(max)	Phosphor Bronze	Tin over Nickel	15,000 PCS
AT2549T-GP-I	AWG#22-#24	1.55mm(max)	Phosphor Bronze	Gold over Nickel	15,000 PCS

## 2.54mm Pitch crimp terminal connector

### TERMINAL

- Part NO.:AT2549T-xP-K
- Applicable wire:AWG#22-#30
- Material:Phosphor Bronze
- Finish:Tin Plated or Gold
- Used in AH2549K AH2549K-2 series Housing

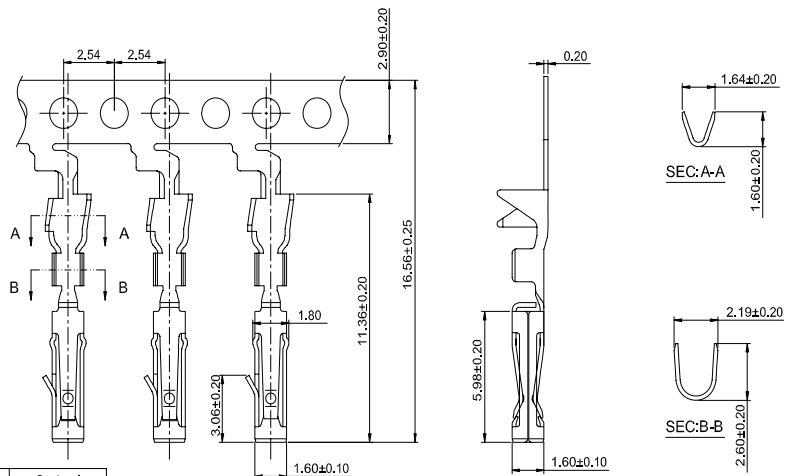

Ordering information & Specifications

Part NO.	Wire Range	Insulation O.D.	Material	Finish	Qty/reel
AT2549T-TP-K	AWG#22-#30	1.50mm(max)	Phosphor Bronze	Tin over Nickel	20,000 PCS
AT2549T-GP-K	AWG#22-#30	1.50mm(max)	Phosphor Bronze	Gold over Nickel	20,000 PCS

Connectors Expert Around You

## 2.54mm Pitch crimp terminal connector

### TERMINAL

- Part NO.:AT2549T-xP-K-H
- Applicable wire:AWG#20-#22
- Material:Phosphor Bronze
- Finish:Tin Plated or Gold
- Used in AH2549K AH2549K-2 series Housing

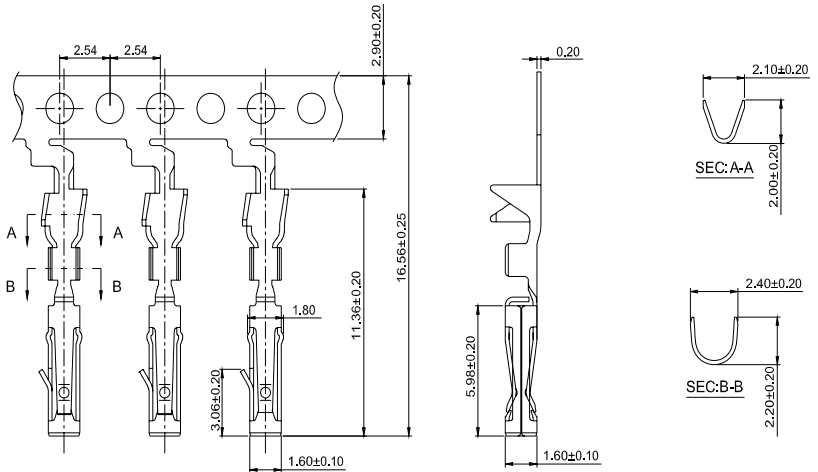

### Ordering information & Specifications

Part NO.	Wire Range	Insulation O.D.	Material	Finish	Qty/reel
AT2549T-TP-K-H	AWG#20-#22	1.60mm(max)	Phosphor Bronze	Tin over Nickel	20,000 PCS
AT2549T-GP-K-H	AWG#20-#22	1.60mm(max)	Phosphor Bronze	Gold over Nickel	20,000 PCS

Wire to Board

## 2.54mm Pitch crimp terminal connector

### TERMINAL

- Part NO.:AT2549T-xP-A
- Applicable wire:AWG#22-#28
- Material:Phosphor Bronze
- Finish:Tin Plated or Gold
- Used in AH2549B AH2549B-2 series Housing

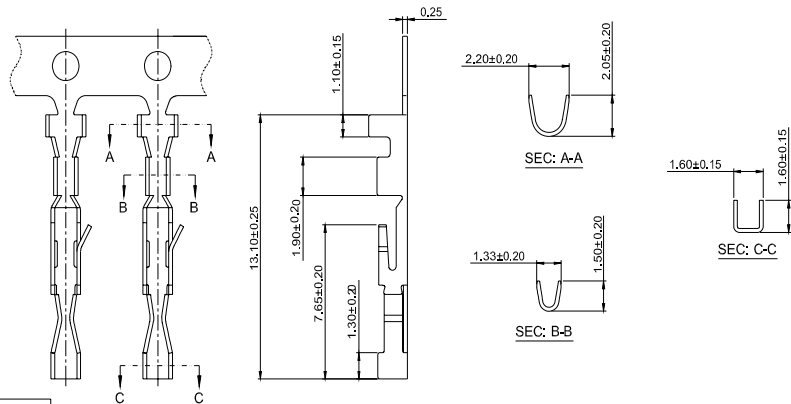

### Ordering information & Specifications

Part NO.	Wire Range	Insulation O.D.	Material	Finish	Qty/reel
AT2549T-TP-A	AWG#22-#28	1.55mm(max)	Phosphor Bronze	Tin over Nickel	20,000 PCS
AT2549T-GP-A	AWG#22-#28	1.55mm(max)	Phosphor Bronze	Gold over Nickel	20,000 PCS

## 2.54mm Pitch housing connector

### HOUSING

- Part NO.:AH2549-xP
- Suitable:AT2549T-B series Terminal
- Mates with:AW2549V AW2549R AW2547VE AW2547RE series Wafer
- Material:PBT,UL94V-0
- Color:Black

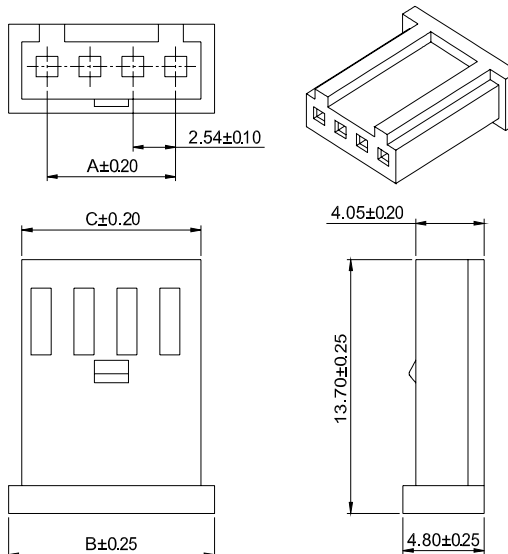

### Ordering Information & Dimensions:

Poles	Part No.	Dimensions (mm)		
		A	B	C
02	AH2549-02P	2.54	7.10	5.60
03	AH2549-03P	5.08	9.64	8.14
04	AH2549-04P	7.62	12.18	10.68
05	AH2549-05P	10.16	14.72	13.22
06	AH2549-06P	12.70	17.26	15.76
07	AH2549-07P	15.24	19.80	18.30
08	AH2549-08P	17.78	22.34	20.84
09	AH2549-09P	20.32	24.88	23.38
10	AH2549-10P	22.86	27.42	25.92
11	AH2549-11P	25.40	29.96	28.46
12	AH2549-12P	27.94	32.50	31.00
13	AH2549-13P	30.48	35.04	33.54
14	AH2549-14P	33.02	37.58	36.08
15	AH2549-15P	35.56	40.12	38.62
16	AH2549-16P	38.10	42.66	41.16
17	AH2549-17P	40.64	45.20	43.70
18	AH2549-18P	43.18	47.74	46.24
19	AH2549-19P	45.72	50.28	48.78
20	AH2549-20P	48.26	52.82	51.32
21	AH2549-21P	50.80	55.36	53.86
22	AH2549-22P	53.34	57.90	56.40



Connectors Expert Around You

## 2.54mm Pitch housing connector

### HOUSING

- Part NO.:AH2549A-xP
- Suitable:AT2549T-B series Terminal
- Mates with:AW2549V AW2549R AW2547VE AW2547RE series Wafer
- Material:PBT,UL94V-0
- Color:Black

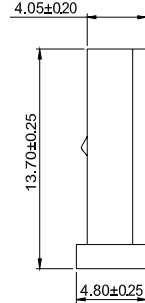
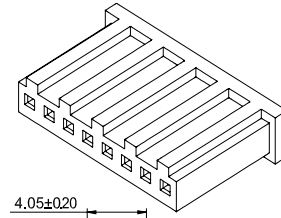
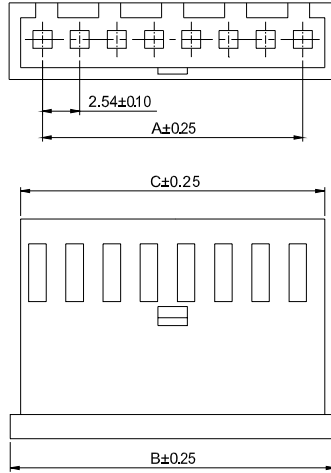

### Ordering Information & Dimensions:

Poles	Part No.	Dimensions (mm)		
		A	B	C
02	AH2549A-02P	2.54	7.10	5.60
04	AH2549A-04P	7.62	12.20	10.68
06	AH2549A-06P	12.70	17.30	15.76
08	AH2549A-08P	17.78	22.30	20.84
09	AH2549A-09P	20.32	24.84	23.38
10	AH2549A-10P	22.86	27.38	25.92
12	AH2549A-12P	27.94	32.46	31.00
15	AH2549A-15P	35.56	41.08	38.62
22	AH2549A-22P	53.34	58.86	56.40

Wire to Board

## 2.54mm Pitch dual row housing connector

### HOUSING

- Part NO.:AH2549I-2xNP
- Suitable:AT2549T-GP-I series Terminal
- Material:Nylon 66,UL94V-0
- Color:White

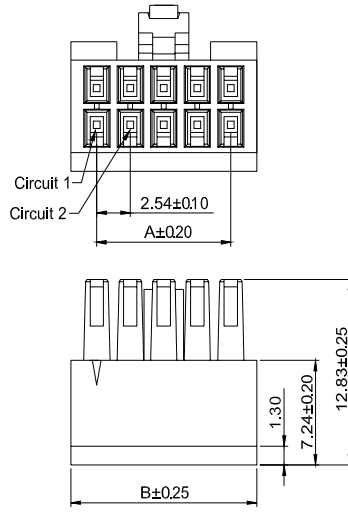

### Ordering Information & Dimensions:

Poles	Part No.	Dimensions (mm)	
		A	B
04	AH2549I-2x02P	2.54	8.48
06	AH2549I-2x03P	5.08	11.02
08	AH2549I-2x04P	7.62	13.56
10	AH2549I-2x05P	10.16	16.10
12	AH2549I-2x06P	12.70	18.64
14	AH2549I-2x07P	15.24	21.18
16	AH2549I-2x08P	17.78	23.72
18	AH2549I-2x09P	20.32	26.26
20	AH2549I-2x10P	22.86	28.80
22	AH2549I-2x11P	25.40	31.34
24	AH2549I-2x12P	27.94	33.88
26	AH2549I-2x13P	30.48	36.42
28	AH2549I-2x14P	33.02	38.96
30	AH2549I-2x15P	35.56	41.50
32	AH2549I-2x16P	38.10	44.04
34	AH2549I-2x17P	40.64	46.58
36	AH2549I-2x18P	43.18	49.12
38	AH2549I-2x19P	45.72	51.66
40	AH2549I-2x20P	48.26	54.20
42	AH2549I-2x21P	50.80	56.74
44	AH2549I-2x22P	53.34	59.28
46	AH2549I-2x23P	55.88	61.82
48	AH2549I-2x24P	58.42	64.36
50	AH2549I-2x25P	60.96	66.90

## 2.54mm Pitch dual row housing connector

### HOUSING

- Part NO.:AH2549L-2xNP
- Suitable:AT2549T-C series Terminal
- Mates with:AW2547V-2 AW2547R-2 series Wafer
- Material:PBT,UL94V-0
- Color:Black

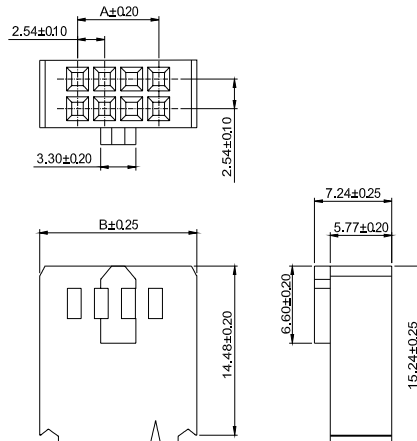

### Ordering Information & Dimensions:

Poles	Part No.	Dimensions (mm)		Poles	Part No.	Dimensions (mm)	
		A	B			A	B
08	AH2549L-2x04P	7.62	14.73	38	AH2549L-2x19P	45.72	52.83
10	AH2549L-2x05P	10.16	17.27	40	AH2549L-2x20P	48.26	55.37
12	AH2549L-2x06P	12.70	19.81	42	AH2549L-2x21P	50.80	57.91
14	AH2549L-2x07P	15.24	22.35	44	AH2549L-2x22P	53.34	60.45
16	AH2549L-2x08P	17.78	24.89	46	AH2549L-2x23P	55.88	62.99
18	AH2549L-2x09P	20.32	27.43	48	AH2549L-2x24P	58.42	65.53
20	AH2549L-2x10P	22.86	29.97	50	AH2549L-2x25P	60.96	68.07
22	AH2549L-2x11P	25.40	32.51	52	AH2549L-2x26P	63.50	70.61
24	AH2549L-2x12P	27.94	35.05	54	AH2549L-2x27P	66.04	73.15
26	AH2549L-2x13P	30.48	37.59	56	AH2549L-2x28P	68.58	75.69
28	AH2549L-2x14P	33.02	40.13	58	AH2549L-2x29P	71.12	78.23
30	AH2549L-2x15P	35.56	42.67	60	AH2549L-2x30P	73.66	80.77
32	AH2549L-2x16P	38.10	45.21	62	AH2549L-2x31P	76.20	83.31
34	AH2549L-2x17P	40.64	47.75	64	AH2549L-2x32P	78.74	85.85
36	AH2549L-2x18P	43.18	50.29				

Connectors Expert Around You

## 2.54mm Pitch single row housing connector

HOUSING

- Part NO.:AH2549B-xP
- Suitable:AT2549T-A series Terminal
- Mates with:AW2549VB AW2549RB series Wafer
- Material:Nylon 66+15%GF,UL94V-0
- Color:Blue

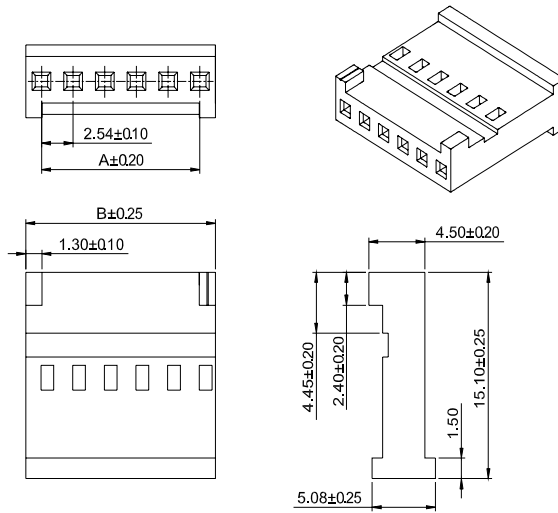

Ordering Information & Dimensions:

Poles	Part No.	Dimensions (mm)	
		A	B
02	AH2549B-02P	2.54	5.08
03	AH2549B-03P	5.08	7.62
04	AH2549B-04P	7.62	10.16
05	AH2549B-05P	10.16	12.70
06	AH2549B-06P	12.70	15.24
07	AH2549B-07P	15.24	17.78
08	AH2549B-08P	17.78	20.32
09	AH2549B-09P	20.32	22.86
10	AH2549B-10P	22.86	25.40
12	AH2549B-12P	27.94	30.48
15	AH2549B-15P	35.56	38.10
18	AH2549B-18P	43.18	45.72

Wire to Board

## 2.54mm Pitch single row housing connector

HOUSING

- Part NO.:AH2549C-xP
- Suitable:AT2549T-C series Terminal
- Mates with:AW2541 series Wafer
- Material:PBT,UL94V-0
- Color:Black

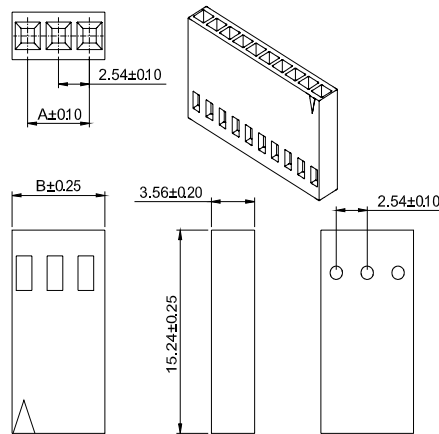

Ordering Information & Dimensions:

Poles	Part No.	Dimensions (mm)		Poles	Part No.	Dimensions (mm)	
		A	B			A	B
03	AH2549C-03P	5.08	7.62	20	AH2549C-20P	48.26	50.80
04	AH2549C-04P	7.62	10.16	21	AH2549C-21P	50.80	53.34
05	AH2549C-05P	10.16	12.70	22	AH2549C-22P	53.34	55.88
06	AH2549C-06P	12.70	15.24	23	AH2549C-23P	55.88	58.42
07	AH2549C-07P	15.24	17.78	24	AH2549C-24P	58.42	60.96
08	AH2549C-08P	17.78	20.32	25	AH2549C-25P	60.96	63.50
09	AH2549C-09P	20.32	22.86	26	AH2549C-26P	63.50	66.04
10	AH2549C-10P	22.86	25.40	27	AH2549C-27P	66.04	68.58
11	AH2549C-11P	25.40	27.94	28	AH2549C-28P	68.58	71.12
12	AH2549C-12P	27.94	30.48	29	AH2549C-29P	71.12	73.66
13	AH2549C-13P	30.48	33.02	30	AH2549C-30P	73.66	76.20
14	AH2549C-14P	33.02	35.56	31	AH2549C-31P	76.20	78.74
15	AH2549C-15P	35.56	38.10	32	AH2549C-32P	78.74	81.28
16	AH2549C-16P	38.10	40.64	33	AH2549C-33P	81.28	83.82
17	AH2549C-17P	40.64	43.18	34	AH2549C-34P	83.82	86.36
18	AH2549C-18P	43.18	45.72	35	AH2549C-35P	86.36	88.90
19	AH2549C-19P	45.72	48.26	36	AH2549C-36P	88.90	91.44

## 2.54mm Pitch single row housing connector

HOUSING

- Part NO.:AH2549D-xP
- Suitable:AT2549T-C series Terminal
- Mates with:AW2547VF AW2547RF series Wafer
- Material:PBT,UL94V-0
- Color:Black

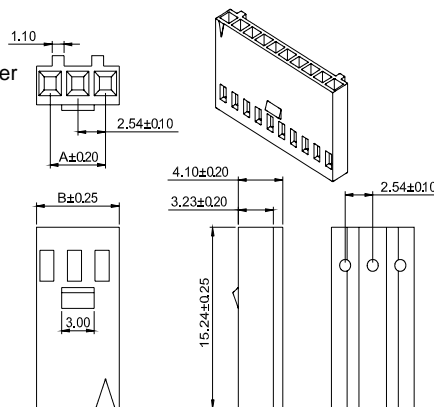

Ordering Information & Dimensions:

Poles	Part No.	Dimensions (mm)		Poles	Part No.	Dimensions (mm)	
		A	B			A	B
03	AH2549D-03P	5.08	7.62	20	AH2549D-20P	48.26	50.80
04	AH2549D-04P	7.62	10.16	21	AH2549D-21P	50.80	53.34
05	AH2549D-05P	10.16	12.70	22	AH2549D-22P	53.34	55.88
06	AH2549D-06P	12.70	15.24	23	AH2549D-23P	55.88	58.42
07	AH2549D-07P	15.24	17.78	24	AH2549D-24P	58.42	60.96
08	AH2549D-08P	17.78	20.32	25	AH2549D-25P	60.96	63.50
09	AH2549D-09P	20.32	22.86	26	AH2549D-26P	63.50	66.04
10	AH2549D-10P	22.86	25.40	27	AH2549D-27P	66.04	68.58
11	AH2549D-11P	25.40	27.94	28	AH2549D-28P	68.58	71.12
12	AH2549D-12P	27.94	30.48	29	AH2549D-29P	71.12	73.66
13	AH2549D-13P	30.48	33.02	30	AH2549D-30P	73.66	76.20
14	AH2549D-14P	33.02	35.56	31	AH2549D-31P	76.20	78.74
15	AH2549D-15P	35.56	38.10	32	AH2549D-32P	78.74	81.28
16	AH2549D-16P	38.10	40.64	33	AH2549D-33P	81.28	83.82
17	AH2549D-17P	40.64	43.18	34	AH2549D-34P	83.82	86.36
18	AH2549D-18P	43.18	45.72	35	AH2549D-35P	86.36	88.90
19	AH2549D-19P	45.72	48.26	36	AH2549D-36P	88.90	91.44

Connectors Expert Around You

## 2.54mm Pitch single row housing connector

### HOUSING

- Part NO.:AH2549K-xP
- Suitable:AT2549T-K series Terminal
- Material:PBT,UL94V-0
- Color:Blue

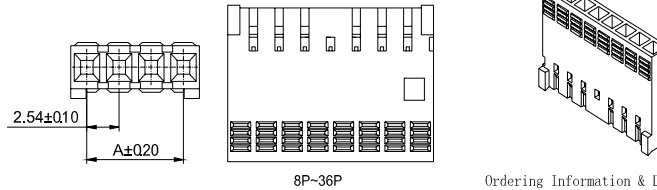

Ordering Information & Dimensions:

Poles	Part No.	Dimensions (mm)		Poles	Part No.	Dimensions (mm)	
		A	B			A	B
02	AH2549K-02P	2.54	5.08	20	AH2549K-20P	48.26	50.80
03	AH2549K-03P	5.08	7.62	21	AH2549K-21P	50.80	53.34
04	AH2549K-04P	7.62	10.16	22	AH2549K-22P	53.34	55.88
05	AH2549K-05P	10.16	12.70	23	AH2549K-23P	55.88	58.42
06	AH2549K-06P	12.70	15.24	24	AH2549K-24P	58.42	60.96
07	AH2549K-07P	15.24	17.78	25	AH2549K-25P	60.96	63.50
08	AH2549K-08P	17.78	20.32	26	AH2549K-26P	63.50	66.04
09	AH2549K-09P	20.32	22.86	27	AH2549K-27P	66.04	68.58
10	AH2549K-10P	22.86	25.40	28	AH2549K-28P	68.58	71.12
11	AH2549K-11P	25.40	27.94	29	AH2549K-29P	71.12	73.66
12	AH2549K-12P	27.94	30.48	30	AH2549K-30P	73.66	76.20
13	AH2549K-13P	30.48	33.02	31	AH2549K-31P	76.20	78.74
14	AH2549K-14P	33.02	35.56	32	AH2549K-32P	78.74	81.28
15	AH2549K-15P	35.56	38.10	33	AH2549K-33P	81.28	83.82
16	AH2549K-16P	38.10	40.64	34	AH2549K-34P	83.82	86.36
17	AH2549K-17P	40.64	43.18	35	AH2549K-35P	86.36	88.90
18	AH2549K-18P	43.18	45.72	36	AH2549K-36P	88.90	91.44
19	AH2549K-19P	45.72	48.26				

Wire to Board

## 2.54mm Pitch dual row housing connector

### HOUSING

- Part NO.:AH2549-2xNP
- Suitable:AT2549T-B series Terminal
- Mates with:AW2549V-2 AW2549R-2 series Wafer
- Material:PBT,UL94V-0
- Color:Black

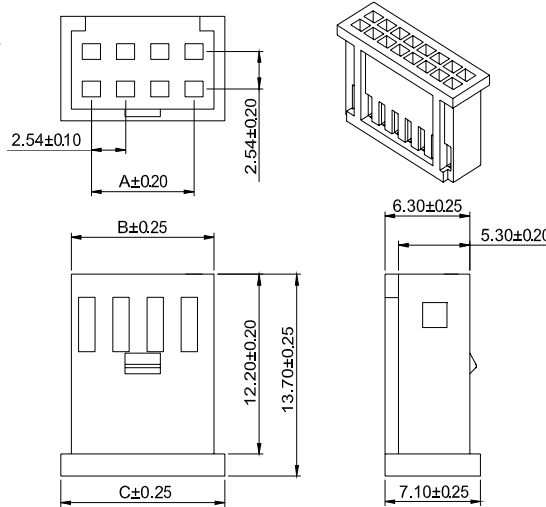

Ordering Information & Dimensions:

Poles	Part No.	Dimensions (mm)		
		A	B	C
04	AH2549-2x02P	2.54	5.60	7.10
06	AH2549-2x03P	5.08	8.14	9.64
08	AH2549-2x04P	7.62	10.68	12.18
10	AH2549-2x05P	10.16	13.22	14.72
12	AH2549-2x06P	12.70	15.76	17.26
14	AH2549-2x07P	15.24	18.30	19.80
16	AH2549-2x08P	17.78	20.84	22.34
18	AH2549-2x09P	20.32	23.38	24.88
20	AH2549-2x10P	22.86	25.92	27.42
22	AH2549-2x11P	25.40	28.46	29.96
24	AH2549-2x12P	27.94	31.00	32.50
26	AH2549-2x13P	30.48	33.54	35.04
28	AH2549-2x14P	33.02	36.08	37.58
30	AH2549-2x15P	35.56	38.62	40.12
32	AH2549-2x16P	38.10	41.16	42.66
34	AH2549-2x17P	40.64	43.70	45.20
36	AH2549-2x18P	43.18	46.24	47.74
38	AH2549-2x19P	45.72	48.78	50.28
40	AH2549-2x20P	48.26	51.32	52.82
42	AH2549-2x21P	50.80	53.86	55.36
44	AH2549-2x22P	53.34	56.40	57.90

## 2.54mm Pitch dual row housing connector

### HOUSING

- Part NO.:AH2549B-2xNP
- Suitable:AT2549T-A series Terminal
- Mates with:AW2549VB-2 AW2549RB-2 series Wafer
- Material:Nylon 66,UL94V-0
- Color:Blue

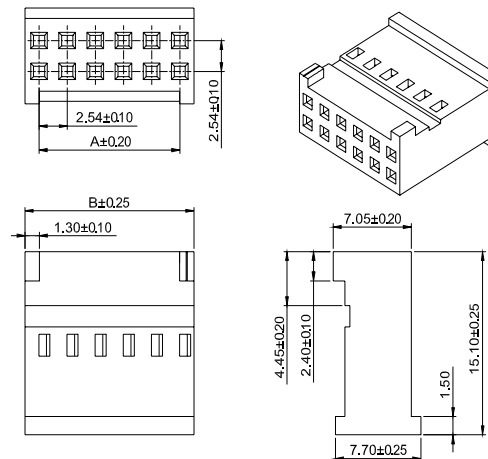

Ordering Information & Dimensions:

Poles	Part No.	Dimensions (mm)	
		A	B
06	AH2549B-2x03P	5.08	7.62
08	AH2549B-2x04P	7.62	10.16
10	AH2549B-2x05P	10.16	12.70
12	AH2549B-2x06P	12.70	15.24
14	AH2549B-2x07P	15.24	17.78
16	AH2549B-2x08P	17.78	20.32
18	AH2549B-2x09P	20.32	22.86
20	AH2549B-2x10P	22.86	25.40
24	AH2549B-2x12P	27.94	30.48
30	AH2549B-2x15P	35.56	38.10
36	AH2549B-2x18P	43.18	45.72

## Connectors Expert Around You

### 2.54mm Pitch dual row housing connector

#### HOUSING

- Part NO.:AH2549C-2xNP
- Suitable:AT2549T-C series Terminal
- Material:PBT,UL94V-0
- Color:Black

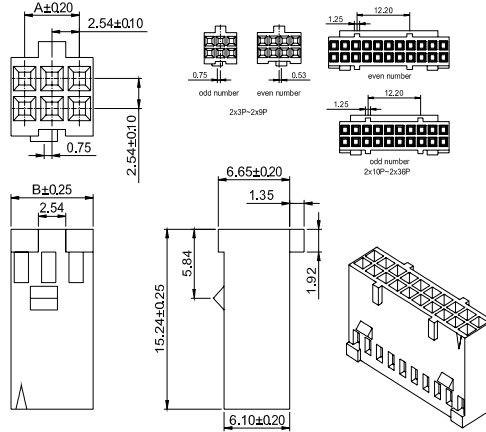

#### Ordering Information & Dimensions:

Poles	Part No.	Dimensions (mm)		Poles	Part No.	Dimensions (mm)	
		A	B			A	B
06	AH2549C-2x03P	5.08	7.62	40	AH2549C-2x30P	48.26	50.80
08	AH2549C-2x04P	7.62	10.16	42	AH2549C-2x21P	50.80	53.34
10	AH2549C-2x05P	10.16	12.70	44	AH2549C-2x22P	53.34	55.88
12	AH2549C-2x06P	12.70	15.24	46	AH2549C-2x23P	55.88	58.42
14	AH2549C-2x07P	15.24	17.78	48	AH2549C-2x24P	58.42	60.96
16	AH2549C-2x08P	17.78	20.32	50	AH2549C-2x25P	60.96	63.50
18	AH2549C-2x09P	20.32	22.86	52	AH2549C-2x26P	63.50	66.04
20	AH2549C-2x10P	22.86	25.40	54	AH2549C-2x27P	66.04	68.58
22	AH2549C-2x11P	25.40	27.94	56	AH2549C-2x28P	68.58	71.12
24	AH2549C-2x12P	27.94	30.48	58	AH2549C-2x29P	71.12	73.66
26	AH2549C-2x13P	30.48	33.02	60	AH2549C-2x30P	73.66	76.20
28	AH2549C-2x14P	33.02	35.56	62	AH2549C-2x31P	76.20	78.74
30	AH2549C-2x15P	35.56	38.10	64	AH2549C-2x32P	78.74	81.28
32	AH2549C-2x16P	38.10	40.64	66	AH2549C-2x33P	81.28	83.82
34	AH2549C-2x17P	40.64	43.18	68	AH2549C-2x34P	83.82	86.36
36	AH2549C-2x18P	43.18	45.72	70	AH2549C-2x35P	86.36	88.90
38	AH2549C-2x19P	45.72	48.26	72	AH2549C-2x36P	88.90	91.44

Wire to Board

### 2.54mm Pitch dual row housing connector

#### HOUSING

- Part NO.:AH2549D-2xNP
- Suitable:AT2549T-C series Terminal
- Material:PBT,UL94V-0
- Color:Black

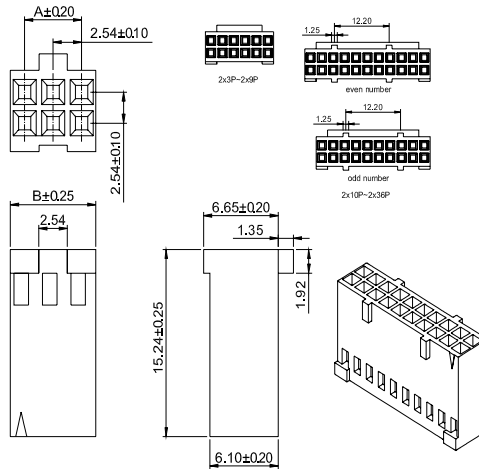

#### Ordering Information & Dimensions:

Poles	Part No.	Dimensions (mm)		Poles	Part No.	Dimensions (mm)	
		A	B			A	B
06	AH2549D-2x03P	5.08	7.62	40	AH2549D-2x20P	48.26	50.80
08	AH2549D-2x04P	7.62	10.16	42	AH2549D-2x21P	50.80	53.34
10	AH2549D-2x05P	10.16	12.70	44	AH2549D-2x22P	53.34	55.88
12	AH2549D-2x06P	12.70	15.24	46	AH2549D-2x23P	55.88	58.42
14	AH2549D-2x07P	15.24	17.78	48	AH2549D-2x24P	58.42	60.96
16	AH2549D-2x08P	17.78	20.32	50	AH2549D-2x25P	60.96	63.50
18	AH2549D-2x09P	20.32	22.86	52	AH2549D-2x26P	63.50	66.04
20	AH2549D-2x10P	22.86	25.40	54	AH2549D-2x27P	66.04	68.58
22	AH2549D-2x11P	25.40	27.94	56	AH2549D-2x28P	68.58	71.12
24	AH2549D-2x12P	27.94	30.48	58	AH2549D-2x29P	71.12	73.66
26	AH2549D-2x13P	30.48	33.02	60	AH2549D-2x30P	73.66	76.20
28	AH2549D-2x14P	33.02	35.56	62	AH2549D-2x31P	76.20	78.74
30	AH2549D-2x15P	35.56	38.10	64	AH2549D-2x32P	78.74	81.28
32	AH2549D-2x16P	38.10	40.64	66	AH2549D-2x33P	81.28	83.82
34	AH2549D-2x17P	40.64	43.18	68	AH2549D-2x34P	83.82	86.36
36	AH2549D-2x18P	43.18	45.72	70	AH2549D-2x35P	86.36	88.90
38	AH2549D-2x19P	45.72	48.26	72	AH2549D-2x36P	88.90	91.44

### 2.54mm Pitch dual row housing connector

#### HOUSING

- Part NO.:AH2549E-2xNP
- Suitable:AT2549T-C series Terminal
- Mates with:AW2541 series Wafer
- Material:PBT,UL94V-0
- Color:Black

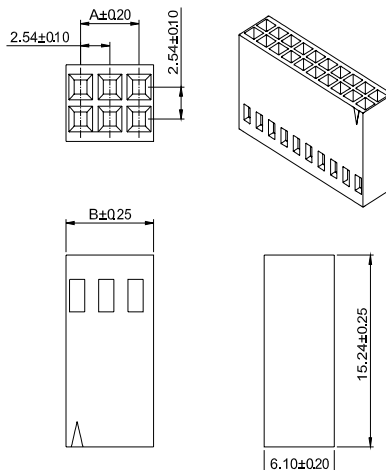

#### Ordering Information & Dimensions:

Poles	Part No.	Dimensions (mm)		Poles	Part No.	Dimensions (mm)	
		A	B			A	B
06	AH2549E-2x03P	5.08	7.62	40	AH2549E-2x20P	48.26	50.80
08	AH2549E-2x04P	7.62	10.16	42	AH2549E-2x21P	50.80	53.34
10	AH2549E-2x05P	10.16	12.70	44	AH2549E-2x22P	53.34	55.88
12	AH2549E-2x06P	12.70	15.24	46	AH2549E-2x23P	55.88	58.42
14	AH2549E-2x07P	15.24	17.78	48	AH2549E-2x24P	58.42	60.96
16	AH2549E-2x08P	17.78	20.32	50	AH2549E-2x25P	60.96	63.50
18	AH2549E-2x09P	20.32	22.86	52	AH2549E-2x26P	63.50	66.04
20	AH2549E-2x10P	22.86	25.40	54	AH2549E-2x27P	66.04	68.58
22	AH2549E-2x11P	25.40	27.94	56	AH2549E-2x28P	68.58	71.12
24	AH2549E-2x12P	27.94	30.48	58	AH2549E-2x29P	71.12	73.66
26	AH2549E-2x13P	30.48	33.02	60	AH2549E-2x30P	73.66	76.20
28	AH2549E-2x14P	33.02	35.56	62	AH2549E-2x31P	76.20	78.74
30	AH2549E-2x15P	35.56	38.10	64	AH2549E-2x32P	78.74	81.28
32	AH2549E-2x16P	38.10	40.64	66	AH2549E-2x33P	81.28	83.82
34	AH2549E-2x17P	40.64	43.18	68	AH2549E-2x34P	83.82	86.36
36	AH2549E-2x18P	43.18	45.72	70	AH2549E-2x35P	86.36	88.90
38	AH2549E-2x19P	45.72	48.26	72	AH2549E-2x36P	88.90	91.44

## Connectors Expert Around You

### 2.54mm Pitch dual row housing connector

#### HOUSING

- Part NO.:AH2549G-2xNP
- Suitable:AT2549T-C series Terminal
- Mates with:AW2541 series Wafer
- Material:PBT,UL94V-0
- Color:Black

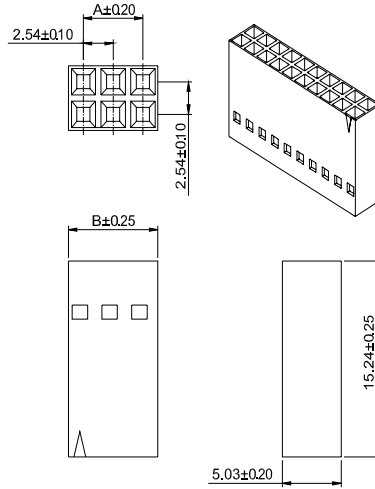

#### Ordering Information & Dimensions:

Poles	Part No.	Dimensions (mm)		Poles	Part No.	Dimensions (mm)	
		A	B			A	B
06	AH2549G-2x03P	5.08	7.62	40	AH2549G-2x20P	48.26	50.80
08	AH2549G-2x04P	7.62	10.16	42	AH2549G-2x21P	50.80	53.34
10	AH2549G-2x05P	10.16	12.70	44	AH2549G-2x22P	53.34	55.88
12	AH2549G-2x06P	12.70	15.24	46	AH2549G-2x23P	55.88	58.42
14	AH2549G-2x07P	15.24	17.78	48	AH2549G-2x24P	58.42	60.96
16	AH2549G-2x08P	17.78	20.32	50	AH2549G-2x25P	60.96	63.50
18	AH2549G-2x09P	20.32	22.86	52	AH2549G-2x26P	63.50	66.04
20	AH2549G-2x10P	22.86	25.40	54	AH2549G-2x27P	66.04	68.58
22	AH2549G-2x11P	25.40	27.94	56	AH2549G-2x28P	68.58	71.12
24	AH2549G-2x12P	27.94	30.48	58	AH2549G-2x29P	71.12	73.66
26	AH2549G-2x13P	30.48	33.02	60	AH2549G-2x30P	73.66	76.20
28	AH2549G-2x14P	33.02	35.56	62	AH2549G-2x31P	76.20	78.74
30	AH2549G-2x15P	35.56	38.10	64	AH2549G-2x32P	78.74	81.28
32	AH2549G-2x16P	38.10	40.64	66	AH2549G-2x33P	81.28	83.82
34	AH2549G-2x17P	40.64	43.18	68	AH2549G-2x34P	83.82	86.36
36	AH2549G-2x18P	43.18	45.72	70	AH2549G-2x35P	86.36	88.90
38	AH2549G-2x19P	45.72	48.26	72	AH2549G-2x36P	88.90	91.44

### 2.54mm Pitch dual row housing connector

#### HOUSING

- Part NO.:AH2549G-N-2xNP
- Suitable:AT2549T-C series Terminal
- Mates with:AW2547V-N-2 AW2547R-N-2 series Wafer
- Material:PBT,UL94V-0
- Color:Black

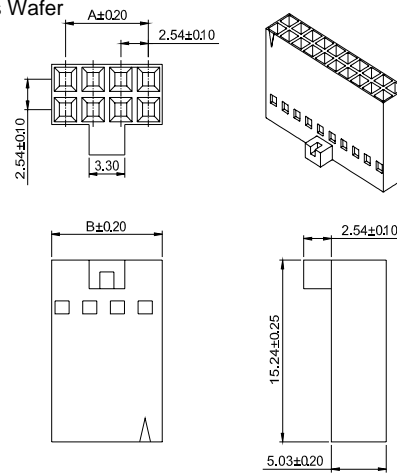

#### Ordering Information & Dimensions:

Poles	Part No.	Dimensions (mm)		Poles	Part No.	Dimensions (mm)	
		A	B			A	B
06	AH2549G-N-2x03P	5.08	7.62	40	AH2549G-N-2x20P	48.26	50.80
08	AH2549G-N-2x04P	7.62	10.16	42	AH2549G-N-2x21P	50.80	53.34
10	AH2549G-N-2x05P	10.16	12.70	44	AH2549G-N-2x22P	53.34	55.88
12	AH2549G-N-2x06P	12.70	15.24	46	AH2549G-N-2x23P	55.88	58.42
14	AH2549G-N-2x07P	15.24	17.78	48	AH2549G-N-2x24P	58.42	60.96
16	AH2549G-N-2x08P	17.78	20.32	50	AH2549G-N-2x25P	60.96	63.50
18	AH2549G-N-2x09P	20.32	22.86	52	AH2549G-N-2x26P	63.50	66.04
20	AH2549G-N-2x10P	22.86	25.40	54	AH2549G-N-2x27P	66.04	68.58
22	AH2549G-N-2x11P	25.40	27.94	56	AH2549G-N-2x28P	68.58	71.12
24	AH2549G-N-2x12P	27.94	30.48	58	AH2549G-N-2x29P	71.12	73.66
26	AH2549G-N-2x13P	30.48	33.02	60	AH2549G-N-2x30P	73.66	76.20
28	AH2549G-N-2x14P	33.02	35.56	62	AH2549G-N-2x31P	76.20	78.74
30	AH2549G-N-2x15P	35.56	38.10	64	AH2549G-N-2x32P	78.74	81.28
32	AH2549G-N-2x16P	38.10	40.64	66	AH2549G-N-2x33P	81.28	83.82
34	AH2549G-N-2x17P	40.64	43.18	68	AH2549G-N-2x34P	83.82	86.36
36	AH2549G-N-2x18P	43.18	45.72	70	AH2549G-N-2x35P	86.36	88.90
38	AH2549G-N-2x19P	45.72	48.26	72	AH2549G-N-2x36P	88.90	91.44

### 2.54mm Pitch dual row housing connector

#### HOUSING

- Part NO.:AH2549I-2xNP
- Suitable:AT2549T-GP-I series Terminal
- Material:Nylon 66,UL94V-0
- Color:White

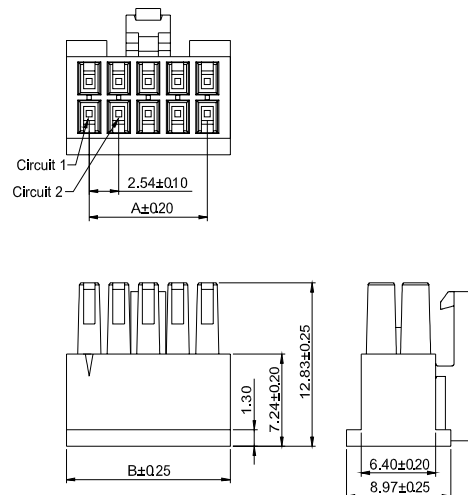

#### Ordering Information & Dimensions:

Poles	Part No.	Dimensions (mm)	
		A	B
04	AH2549I-2x02P	2.54	8.48
06	AH2549I-2x03P	5.08	11.02
08	AH2549I-2x04P	7.62	13.56
10	AH2549I-2x05P	10.16	16.10
12	AH2549I-2x06P	12.70	18.64
14	AH2549I-2x07P	15.24	21.18
16	AH2549I-2x08P	17.78	23.72
18	AH2549I-2x09P	20.32	26.26
20	AH2549I-2x10P	22.86	28.80
22	AH2549I-2x11P	25.40	31.34
24	AH2549I-2x12P	27.94	33.88
26	AH2549I-2x13P	30.48	36.42
28	AH2549I-2x14P	33.02	38.96
30	AH2549I-2x15P	35.56	41.50
32	AH2549I-2x16P	38.10	44.04
34	AH2549I-2x17P	40.64	46.58
36	AH2549I-2x18P	43.18	49.12
38	AH2549I-2x19P	45.72	51.66
40	AH2549I-2x20P	48.26	54.20
42	AH2549I-2x21P	50.80	56.74
44	AH2549I-2x22P	53.34	59.28
46	AH2549I-2x23P	55.88	61.82
48	AH2549I-2x24P	58.42	64.36
50	AH2549I-2x25P	60.96	66.90

## Connectors Expert Around You

### 2.54mm Pitch single row 180° wafer connector

WAFER

- Part NO.:AW2549V-xP
- Material:Pin:Brass/Tin over Nickel
- Insulator:PBT,UL94V-0
- Mates with:AH2549 AH2550-C series Housing
- Nylon 6T is available
- Color:Black

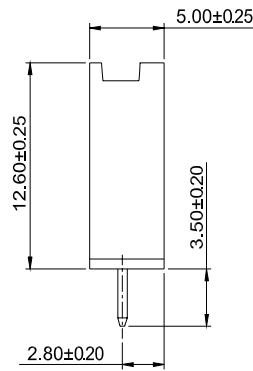
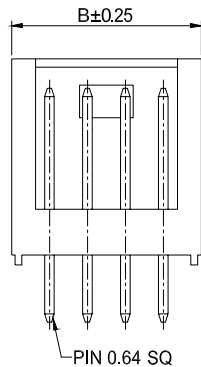
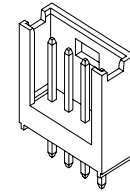
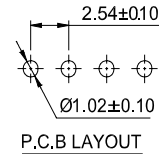
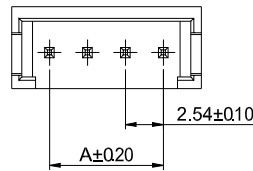

Ordering Information & Dimensions:

Poles	Part No.	Dimensions (mm)	
		A	B
02	AW2549V-02P	2.54	7.62
03	AW2549V-03P	5.08	10.16
04	AW2549V-04P	7.62	12.70
05	AW2549V-05P	10.16	15.24
06	AW2549V-06P	12.70	17.78
07	AW2549V-07P	15.24	20.32
08	AW2549V-08P	17.78	22.86
09	AW2549V-09P	20.32	25.40
10	AW2549V-10P	22.86	27.94
11	AW2549V-11P	25.40	30.48
12	AW2549V-12P	27.94	33.02
13	AW2549V-13P	30.48	35.56
14	AW2549V-14P	33.02	38.10
15	AW2549V-15P	35.56	40.64
16	AW2549V-16P	38.10	43.18
17	AW2549V-17P	40.64	45.72
18	AW2549V-18P	43.18	48.26
19	AW2549V-19P	45.72	50.80
20	AW2549V-20P	48.26	53.34
21	AW2549V-21P	50.80	55.88
22	AW2549V-22P	53.34	58.42

Wire to Board

### 2.54mm Pitch single row 90° wafer connector

WAFER

- Part NO.:AW2549R-xP
- Material:Pin:Brass/Tin over Nickel
- Insulator:PBT,UL94V-0
- Mates with:AH2549 AH2550-C series Housing
- Nylon 6T is available
- Color: Black

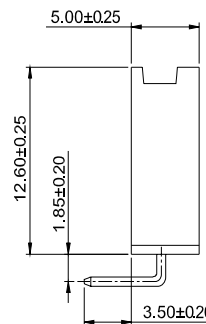
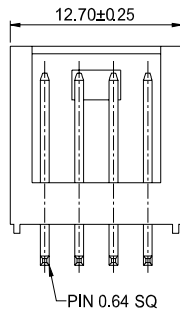
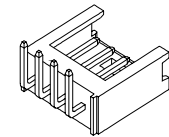
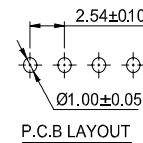
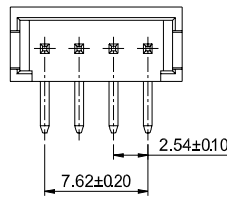

Ordering Information & Dimensions:

Poles	Part No.	Dimensions (mm)	
		A	R
02	AW2549R-02P	2.54	7.62
03	AW2549R-03P	5.08	10.16
04	AW2549R-04P	7.62	12.70
05	AW2549R-05P	10.16	15.24
06	AW2549R-06P	12.70	17.78
07	AW2549R-07P	15.24	20.32
08	AW2549R-08P	17.78	22.86
09	AW2549R-09P	20.32	25.40
10	AW2549R-10P	22.86	27.94
11	AW2549R-11P	25.40	30.48
12	AW2549R-12P	27.94	33.02
13	AW2549R-13P	30.48	35.56
14	AW2549R-14P	33.02	38.10
15	AW2549R-15P	35.56	40.64
16	AW2549R-16P	38.10	43.18
17	AW2549R-17P	40.64	45.72
18	AW2549R-18P	43.18	48.26
19	AW2549R-19P	45.72	50.80
20	AW2549R-20P	48.26	53.34
21	AW2549R-21P	50.80	55.88
22	AW2549R-22P	53.34	58.42

### 2.54mm Pitch single row 180° wafer connector

WAFER

- Part NO.:AW2549VB-xP
- Material:Pin:Brass/Tin over Nickel
- Insulator:Nylon 66,UL94V-0
- Mates with:AH2549B AH2550A series Housing
- Color:Blue

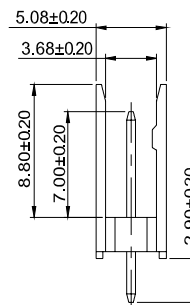
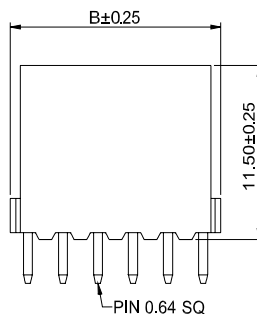
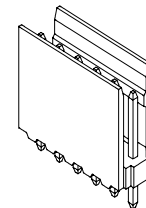
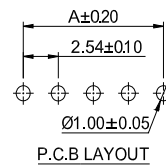
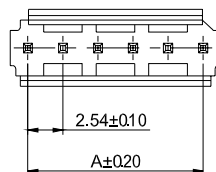

Ordering Information & Dimensions:

Poles	Part No.	Dimensions (mm)	
		A	B
02	AW2549VB-02P	2.54	5.08
03	AW2549VB-03P	5.08	7.62
04	AW2549VB-04P	7.62	10.16
05	AW2549VB-05P	10.16	12.70
06	AW2549VB-06P	12.70	15.24
07	AW2549VB-07P	15.24	17.78
08	AW2549VB-08P	17.78	20.32
10	AW2549VB-10P	22.86	25.40
12	AW2549VB-12P	27.94	30.48
15	AW2549VB-15P	35.56	38.10
17	AW2549VB-17P	40.64	43.18
18	AW2549VB-18P	43.18	45.72

Connectors Expert Around You

## 2.54mm Pitch single row 90° wafer connector

WAFER

- Part NO.:AW2549RB-xP
- Material:Pin:Brass/Tin over Nickel  
Insulator:Nylon 66,UL94V-0
- Mates with:AH2549B AH2550A series Housing
- Color:Blue

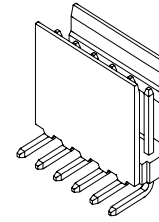
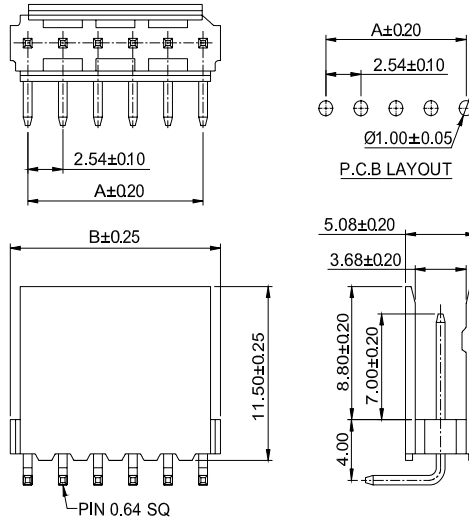

Ordering Information & Dimensions:

Poles	Part No.	Dimensions (mm)	
		A	B
02	AW2549RB-02P	2.54	5.08
03	AW2549RB-03P	5.08	7.62
04	AW2549RB-04P	7.62	10.16
05	AW2549RB-05P	10.16	12.70
06	AW2549RB-06P	12.70	15.24
07	AW2549RB-07P	15.24	17.78
08	AW2549RB-08P	17.78	20.32
10	AW2549RB-10P	22.86	25.40
12	AW2549RB-12P	27.94	30.48
15	AW2549RB-15P	35.56	38.10
17	AW2549RB-17P	40.64	43.18
18	AW2549RB-18P	43.18	45.72

Wire to Board

## 2.54mm Pitch dual row 180° wafer connector

WAFER

- Part NO.:AW2549V-2xNP
- Material:Pin:Brass/Tin over Nickel  
Insulator:PBT,UL94V-0
- Mates with:AH2549-2 series Housing
- Color:Black

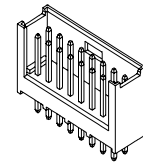
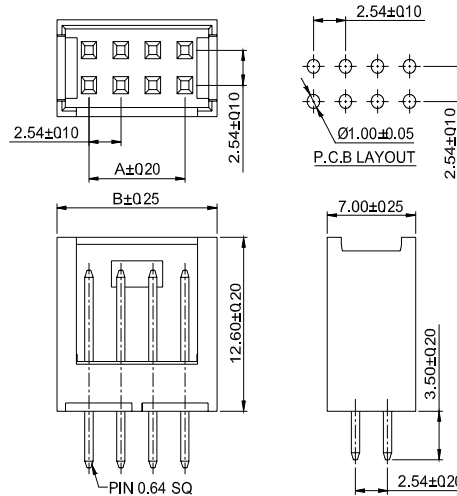

Ordering Information & Dimensions:

Poles	Part No.	Dimensions (mm)	
		A	B
04	AW2549V-2x02P	2.54	7.62
06	AW2549V-2x03P	5.08	10.16
08	AW2549V-2x04P	7.62	12.70
10	AW2549V-2x05P	10.16	15.24
12	AW2549V-2x06P	12.70	17.78
14	AW2549V-2x07P	15.24	20.32
16	AW2549V-2x08P	17.78	22.86
18	AW2549V-2x09P	20.32	25.40
20	AW2549V-2x10P	22.86	27.94
22	AW2549V-2x11P	25.40	30.48
24	AW2549V-2x12P	27.94	33.02
26	AW2549V-2x13P	30.48	35.56
28	AW2549V-2x14P	33.02	38.10
30	AW2549V-2x15P	35.56	40.64
32	AW2549V-2x16P	38.10	43.18
34	AW2549V-2x17P	40.64	45.72
36	AW2549V-2x18P	43.18	48.26
38	AW2549V-2x19P	45.72	50.80
40	AW2549V-2x20P	48.26	53.34
42	AW2549V-2x21P	50.80	55.88
44	AW2549V-2x22P	53.34	58.42

## 2.54mm Pitch dual row 90° wafer connector

WAFER

- Part NO.:AW2549R-2xNP
- Material:Pin:Brass/Tin over Nickel  
Insulator:PBT,UL94V-0
- Mates with:AH2549-2 series Housing
- Color:Black

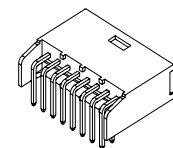
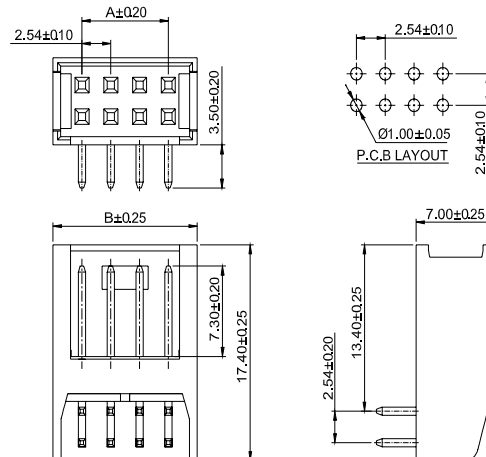

Ordering Information & Dimensions:

Poles	Part No.	Dimensions (mm)	
		A	B
04	AW2549R-2x02P	2.54	7.62
06	AW2549R-2x03P	5.08	10.16
08	AW2549R-2x04P	7.62	12.70
10	AW2549R-2x05P	10.16	15.24
12	AW2549R-2x06P	12.70	17.78
14	AW2549R-2x07P	15.24	20.32
16	AW2549R-2x08P	17.78	22.86
18	AW2549R-2x09P	20.32	25.40
20	AW2549R-2x10P	22.86	27.94
22	AW2549R-2x11P	25.40	30.48
24	AW2549R-2x12P	27.94	33.02
26	AW2549R-2x13P	30.48	35.56
28	AW2549R-2x14P	33.02	38.10
30	AW2549R-2x15P	35.56	40.64
32	AW2549R-2x16P	38.10	43.18
34	AW2549R-2x17P	40.64	45.72
36	AW2549R-2x18P	43.18	48.26
38	AW2549R-2x19P	45.72	50.80
40	AW2549R-2x20P	48.26	53.34
42	AW2549R-2x21P	50.80	55.88
44	AW2549R-2x22P	53.34	58.42



## Connectors Expert Around You

### 2.54mm Pitch dual row 180° wafer connector

WAFER

- Part NO.:AW2549VB-2xNP
- Material:Pin:Brass/Tin over Nickel
- Insulator:Nylon 66,UL94V-0
- Mates with:AH2549B-2 AH2550A-2 series Housing
- Color:Blue

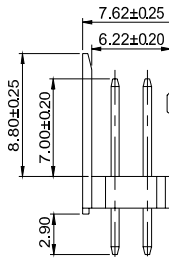
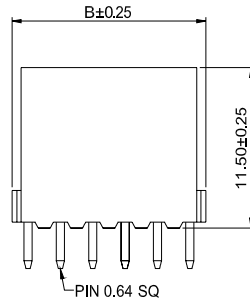
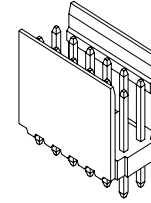
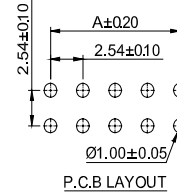
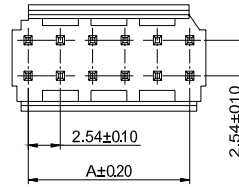

Ordering Information & Dimensions:

Poles	Part No.	Dimensions (mm)	
		A	B
04	AW2549VB-2x02P	2.54	5.08
06	AW2549VB-2x03P	5.08	7.62
08	AW2549VB-2x04P	7.62	10.16
10	AW2549VB-2x05P	10.16	12.70
12	AW2549VB-2x06P	12.70	15.24
14	AW2549VB-2x07P	15.24	17.78
16	AW2549VB-2x08P	17.78	20.32
20	AW2549VB-2x10P	22.86	25.40
24	AW2549VB-2x12P	27.94	30.48
30	AW2549VB-2x15P	35.56	38.10
34	AW2549VB-2x17P	40.64	43.18
36	AW2549VB-2x18P	43.18	45.72

Wire to Board

### 2.54mm Pitch dual row 90° wafer connector

WAFER

- Part NO.:AW2549RB-2xNP
- Material:Pin:Brass/Tin over Nickel
- Insulator:Nylon 66,UL94V-0
- Mates with:AH2549B-2 AH2550A-2 series Housing
- Color:Blue

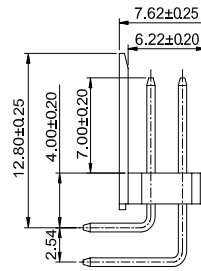
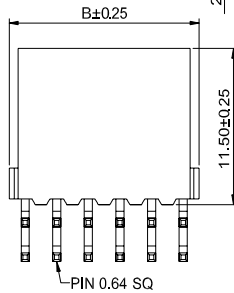
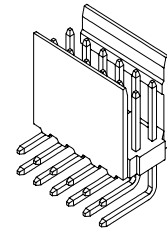
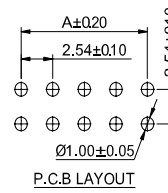
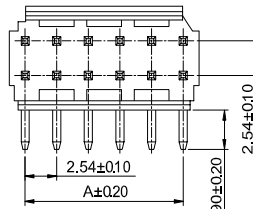

Ordering Information & Dimensions:

Poles	Part No.	Dimensions (mm)	
		A	B
04	AW2549RB-2x02P	2.54	5.08
06	AW2549RB-2x03P	5.08	7.62
08	AW2549RB-2x04P	7.62	10.16
10	AW2549RB-2x05P	10.16	12.70
12	AW2549RB-2x06P	12.70	15.24
14	AW2549RB-2x07P	15.24	17.78
16	AW2549RB-2x08P	17.78	20.32
20	AW2549RB-2x10P	22.86	25.40
24	AW2549RB-2x12P	27.94	30.48
30	AW2549RB-2x15P	35.56	38.10
34	AW2549RB-2x17P	40.64	43.18
36	AW2549RB-2x18P	43.18	45.72

### 2.54mm Pitch dual row 90° wafer connector

WAFER

- Part NO.:AW2549RI-2xNP
- Material:Pin:Brass/Tin over Nickel
- Insulator:LCP,UL94V-0
- Mates with:AH2549I-2xNP series Housing
- Color:Ivory

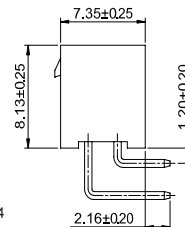
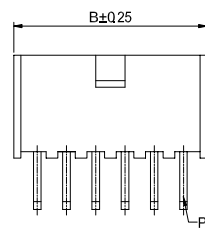
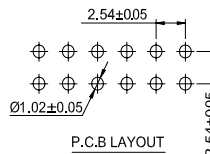
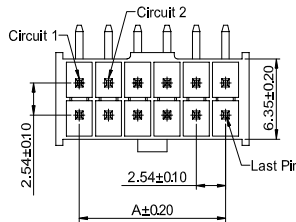

Ordering Information & Dimensions:

Poles	Part No.	Dimensions (mm)	
		A	B
04	AW2549RI-2x02P	2.54	6.60
06	AW2549RI-2x03P	5.08	9.14
08	AW2549RI-2x04P	7.62	11.68
10	AW2549RI-2x05P	10.16	14.22
12	AW2549RI-2x06P	12.70	16.76
14	AW2549RI-2x07P	15.24	19.30
16	AW2549RI-2x08P	17.78	21.84
18	AW2549RI-2x09P	20.32	24.38
20	AW2549RI-2x10P	22.86	26.92
22	AW2549RI-2x11P	25.40	29.46
24	AW2549RI-2x12P	27.94	32.00
26	AW2549RI-2x13P	30.48	34.54
28	AW2549RI-2x14P	33.02	37.08
30	AW2549RI-2x15P	35.56	39.62



Connectors Expert Around You

## 2.54mm Pitch dual row 180° wafer connector

WAFER

- Part NO.:AW2549VI-2xNP
- Material:Pin:Brass/Tin over Nickel
- Insulator:LCP,UL94V-0
- Mates with:AH2549I-2xNP series Housing
- Color:Ivory

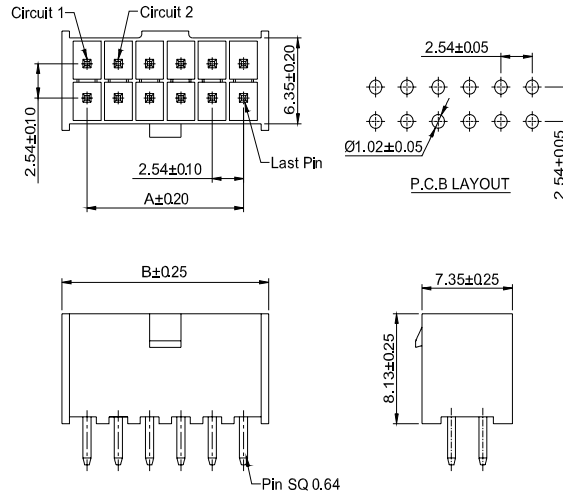

Ordering Information & Dimensions:

Poles	Part No.	Dimensions (mm)	
		A	B
04	AW2549VI-2x02P	2.54	6.60
06	AW2549VI-2x03P	5.08	9.14
08	AW2549VI-2x04P	7.62	11.68
10	AW2549VI-2x05P	10.16	14.22
12	AW2549VI-2x06P	12.70	16.76
14	AW2549VI-2x07P	15.24	19.30
16	AW2549VI-2x08P	17.78	21.84
18	AW2549VI-2x09P	20.32	24.38
20	AW2549VI-2x10P	22.86	26.92
22	AW2549VI-2x11P	25.40	29.46
24	AW2549VI-2x12P	27.94	32.00
26	AW2549VI-2x13P	30.48	34.54
28	AW2549VI-2x14P	33.02	37.08
30	AW2549VI-2x15P	35.56	39.62

Wire to Board

## 2.54mm Pitch dual row 180° wafer-smt connector

WAFER

- Part NO.:AW2549VI-S-2xNP
- Material:Pin:Brass/Tin over Nickel
- Insulator:LCP,UL94V-0
- Mates with:AH2549I-2xNP series Housing
- Color:Ivory

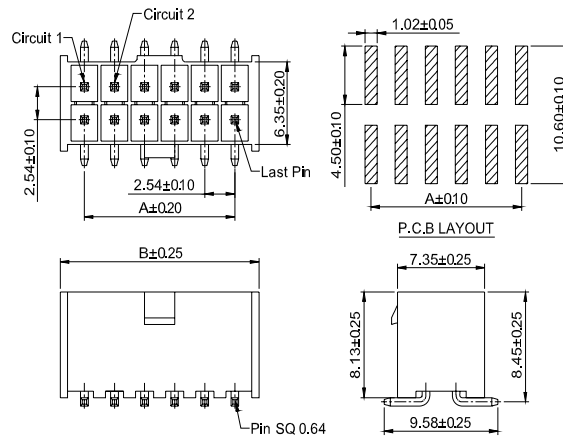

Ordering Information & Dimensions:

Poles	Part No.	Dimensions (mm)	
		A	B
04	AW2549VI-S-2x02P	2.54	6.60
06	AW2549VI-S-2x03P	5.08	9.14
08	AW2549VI-S-2x04P	7.62	11.68
10	AW2549VI-S-2x05P	10.16	14.22
12	AW2549VI-S-2x06P	12.70	16.76
14	AW2549VI-S-2x07P	15.24	19.30
16	AW2549VI-S-2x08P	17.78	21.84
18	AW2549VI-S-2x09P	20.32	24.38
20	AW2549VI-S-2x10P	22.86	26.92
22	AW2549VI-S-2x11P	25.40	29.46
24	AW2549VI-S-2x12P	27.94	32.00
26	AW2549VI-S-2x13P	30.48	34.54
28	AW2549VI-S-2x14P	33.02	37.08
30	AW2549VI-S-2x15P	35.56	39.62