

HSF

RoHS

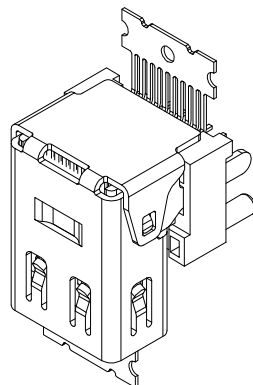
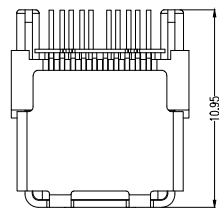

NOTES:

1. MATERIAL
  - 1.1 HOUSING:HI-TEMP PLASTIC (UL94-V-0),BLACK
  - 1.2 CONTACT:COPPER ALLOY(T=0.20),  
PLATING:GOLD PLATED ON CONTACT AREA,  
TIN PLATED ON SOLDER TAILS,UNDER  
NICKEL PLATED.
  - 1.3 SHELL:BRASS(T=0.40),PLATING:NICKEL PLATED,
  - 1.4 SPRING SHELL: STAINLESS SUS304 T=0.20mm
  - 1.5 COVER: HI-TEMP,PLASTIC(UL94V-0)BLACK,
2. SPECIFICATION:
  - 2.1 CURRENT RATING: 0.5 A
  - 2.2 CONTACT RESISTANCE: 30m [ MAX.
  - 2.3 DIELECTRIC WITHSTANDING VOLTAGE: 500V AC  
R.M.S FOR ONE MINUTE.
  - 2.4 INSULATION RESISTANCE: 100M [ MIN AT 500V DC.
  - 2.5 OPERATING TEMPERATURE: -25°C TO+85°C
  - 2.6 DURABILITY: 10000 CYCLES.
  - 2.7 MATING FORCE: 4.5KG MAX.
  - 2.8 UNMATING FORCE: 1.0KG MIN

Ordering Code:

MDP - F - X - X - 01  
 ① ② ③ ④ ⑤

- ① Series No:
- ② Male / female:  
F: female
- ③ Contact Plating:  
1: Selective 1u"  
2: Selective 3u"  
3: Selective 5u"  
4: Selective 15u"  
5: Selective 30u"  
6: All Gold
- ④ Shell Plating:  
1:NICKKL PLATK  
2:TIN-LKAD PLATED  
3:GOLD PLATKD
- ⑤ series number:  
01

A

B

C

D

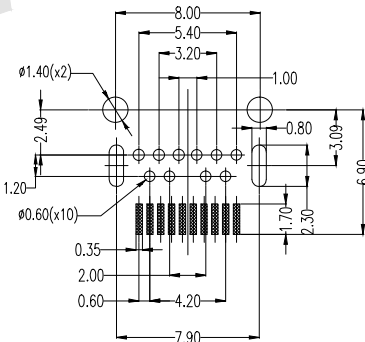
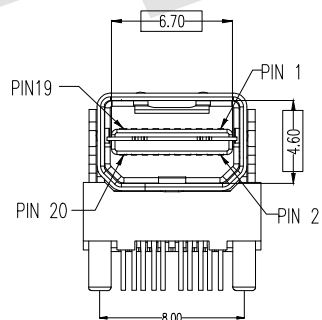
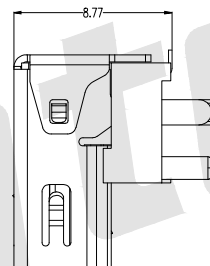
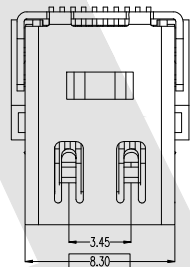
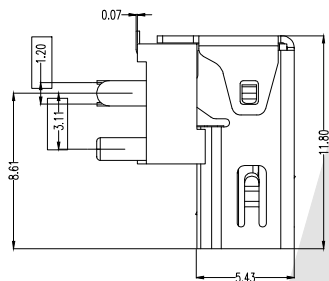

P.C.B LAYOUT (T=1.60mm)  
VIEW BOTTOM(tolerance±0.05)

Unless Otherwise specified tolerance  
 X. ±0.35 X.XX:±0.20  
 X.X:±0.25 X.XXX:±0.15

**Antenk** ANTENK ELECTRONICS CO.,LTD  
 Http://www.antenk.com  
 E-mail:sales@antenk.com

SCALE: As Shown UNIT: mm  
 DRAW Mo Guo Xuan DATE 29/10/2018  
 CHECK BobYang DATE 29/10/2018

TITLE: mini display port Female20P SMT  
(centre height:6.0)



DRAWING NO: MDP-FXX01  
 PRODUCT NO: MDP-FXX01

REV

DESCRIPTION

DATE

1

2

3

4

5

6

7

8