

HSF

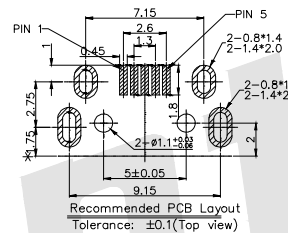

ROHS

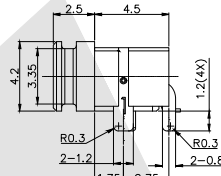
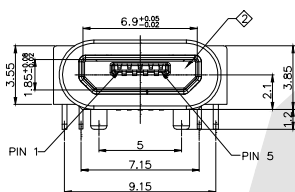
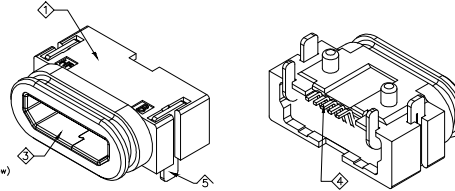
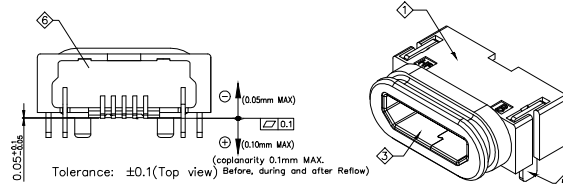
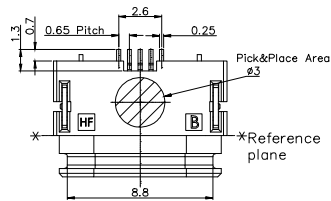

Ordering Code:

WMUFM06 - L - X - X - X  
 ① ② ③ ④ ⑤

- ① Series No:
- ② Insulator Material:  
L:LCP
- ③ Contact Material:  
B:Brass  
P:Phosphor Copper
- ④ Contact Plating:  
G0: Gold flash  
G1: 3u" Gold  
G2: 5u" Gold  
G3: 10u" Gold  
G4: 15u" Gold  
G5: 30u" Gold
- ⑤ Packing:  
A:Tray  
B:Bag  
C:Tape  
D:Tape & Reel

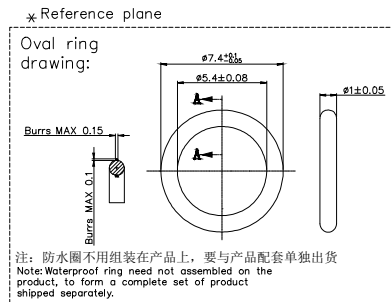
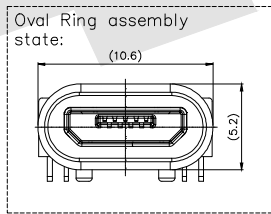
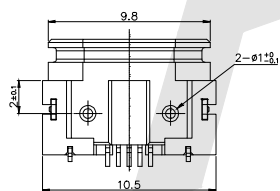

UNLESS OTHERWISE SPECIFIED, TOLERANCE ON DECIMAL:±0.3

Unless Otherwise specified tolerance  
 X. ±0.35 X.XX: ±0.20  
 X.X: ±0.25 X.XXX: ±0.15



ANTENK ELECTRONICS CO., LTD  
 Http://www.antenk.com  
 E-mail:sales@antenk.com

SCALE: As Shown UNIT: mm  
 DRAW: Wu Feng Rong DATE: 07/07/2021  
 CHECK: BobYang DATE: 07/07/2021

TITLE: MICRO USB 5P SMT Receptacle Connector Waterproof Type

REV	DESCRIPTION	DATE

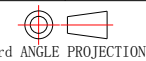

DRAWING NO: WMUFM08-LXXX  
 PRODUCT NO: WMUFM08-LXXX



ROHS

PARKING SPEC

1 Carton 1箱=1000PCS/Carrier Reel 1000只/载盘=10Reel/ Carton 10盘/外箱=10000PCS/ Carton 10000只每箱

Product (产品)



CARRIER TAPE (载带)

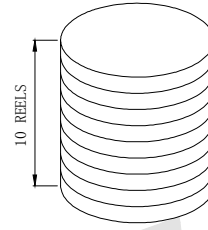
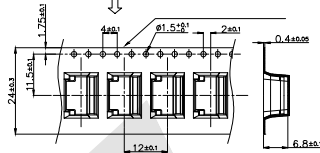

Step 2: Loaded In Carton (10 Reel/Carton)  
第二步: 装入外箱 (10盘/外箱)

NOTE备注  
1. Each Carrier Reel Have 1000 Products Inside.  
每个载盘内装1000个产品。  
2. Each Carton Have 10000 Products Inside.  
每个外箱内装10000个产品。  
3. Carton Size:  
外箱尺寸: 400\*340\*408  
4. Unit: MM  
单位: MM  
5. Use Transparent Tape  
用透明胶带封箱

CARRIER REEL (载盘)

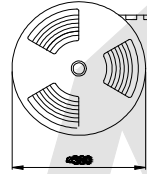

Carton (外箱)

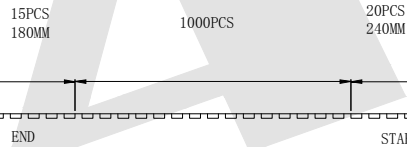
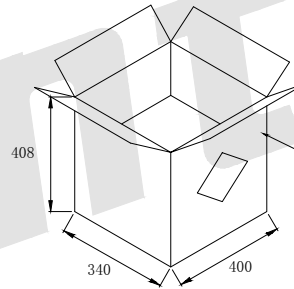

Step 1: Loaded In Carrier Tape (1000PCS/Reel)  
第一步: 载入载带 (1000PCS/盘)  
前端空20PCS。后端空15PCS。实际  
包装 Front End Empty 20 PCS.  
Rear End Empty 15PCS. Actual  
Package 1000PCS

Unless Otherwise specified tolerance  
X. ±0.35 X.XX: ±0.20  
X.X: ±0.25 X.XXX: ±0.15

**Antenk**® ANTENK ELECTRONICS CO., LTD  
Http://www.antenk.com  
E-mail:sales@antenk.com

SCALE: As Shown UNIT: mm

DRAW Wu Feng Rong DATE 07/07/2021

CHECK BobYang DATE 07/07/2021

TITLE: MICRO USB 5P SMT Receptacle Connector  
Waterproof Type Tape Parking

DRAWING NO: WMUFM06-LXXX

PRODUCT NO: WMUFM06-LXXX

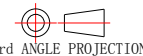

REV	DESCRIPTION	DATE