

HSF

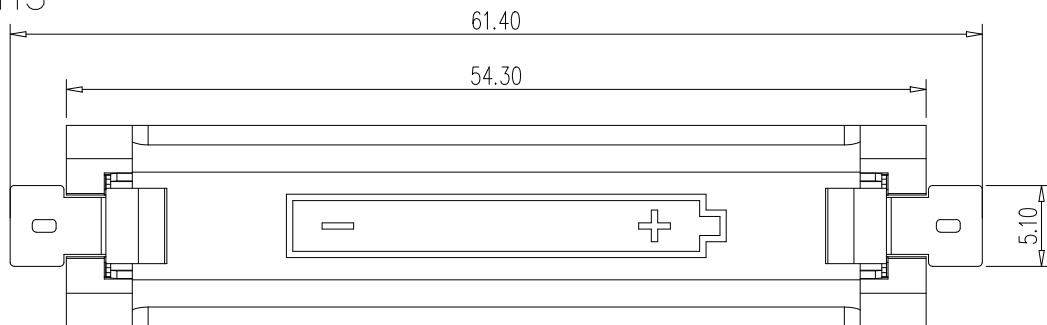

ROHS

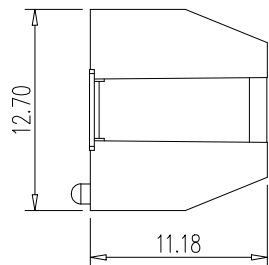

PCB LAYOUT

NOTES:

- 1. BASE:
MATERIAL: HEAT RESISTANCE NYLON, BLACK.
- 2. CONTACT:
MATERIAL: 0.30 THK STAINLESS STEEL

Ordering Code:

BBC - S - G0 - A - 1AAA-020
 ① ② ③ ④ ⑤

① BBC: Battery Holders

② Appearance for the product
M: SMT TYPE

③ Contact Plating
 NI: Nickel SN: Tin
 G0: Gold flash G1: 3U"Gold
 G2: 5U"Gold G3: 10U"Gold
 G4: 15U"Gold G5: 30U"Gold

④ Packing Method
 A: Tray
 R: Tape & reel packing

⑤ Product Number:
 1AAA-020

Unless Otherwise specified tolerance
 X.±0.35 X.XX:±0.20
 X.X:±0.25 X.XXX:±0.15

SCALE: As Shown UNIT: mm
 DRAW ZLA DATE 02/25/2023
 CHECK BobYang DATE 02/25/2023

VER./版本号 3rd ANGLE PROJECTION

Antenk® ANTENK ELECTRONICS CO.,LTD
 Http://www.antenk.com
 E-mail:sales@antenk.com

TITLE: SINGLE AAA BATTERY HOLDER SMT

DRAWING NO: BBC-M-G0-A-1AAA-020

PRODUCT NO: BBC-M-G0-A-1AAA-020

MK/标记	DESCRIPTION/修订内容	DATE/日期(M/D/Y)

HSF



200pcs/reel

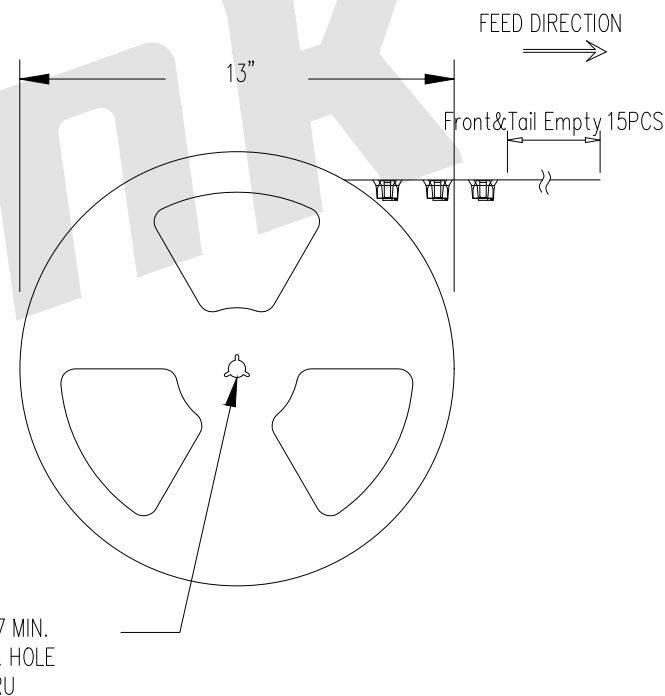
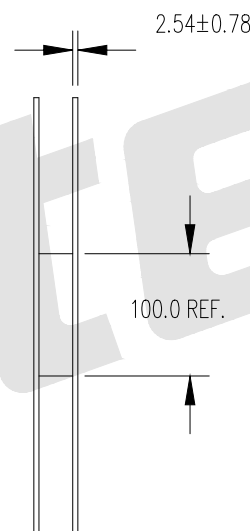
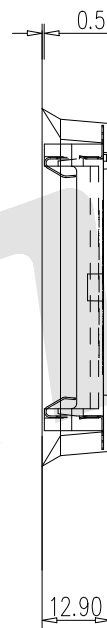
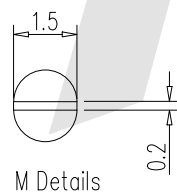
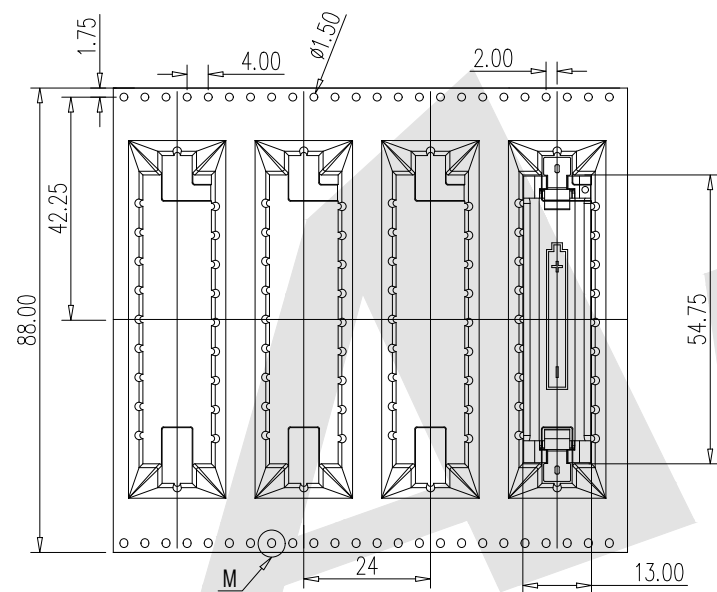

Unless Otherwise specified tolerance
 X.±0.35 X.XX:±0.20
 X.X:±0.25 X.XXX:±0.15

SCALE: As Shown UNIT: mm
 DRAW ZLA DATE 02/25/2023
 CHECK BobYang DATE 02/25/2023

VER./版本号
 3rd ANGLE PROJECTION

Antenk® ANTENK ELECTRONICS CO.,LTD
 Http://www.antenk.com
 E-mail:sales@antenk.com

TITLE: AAA Battery Holder Packing
 DRAWING NO: BBC-M-G0-R-1AAA-020
 PRODUCT NO: BBC-M-G0-R-1AAA-020

MK/标记	DESCRIPTION/修订内容	DATE/日期(M/D/Y)	1	2	3	4	5	6	7	8
-------	------------------	----------------	---	---	---	---	---	---	---	---