



Ordering Information:

DW3961RA-XP-A - *
1 2

1.Part No.

2.Type:

(Blank):TYPE 1

H:TYPE 2

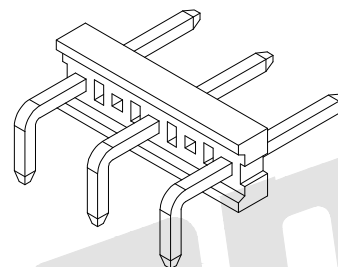

SPECIFICATIONS

- Voltage rating: 250V AC,DC
- Current rating: 7A AC,DC
- Withstanding Voltage: 1500V AC/minute
- Insulation resistance:1000MΩ min
- Temperature range: -40℃~+105℃

WAFER

- Part NO: DW3961RA-XP-A
- Material: Pin: Brass/Tin over Nickel
Insulator: Nylon 66, UL94V-0
- Mates with: DH3961 series Housing
- Color: Natual

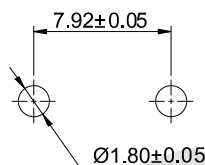
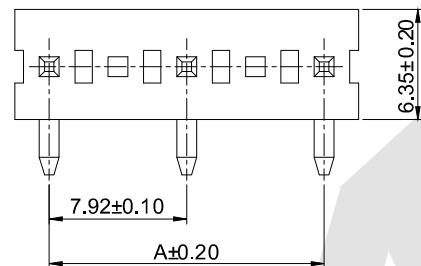

P.C.B LAYOUT

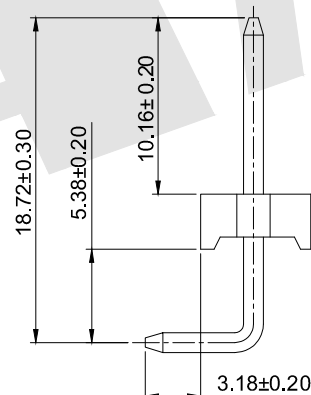
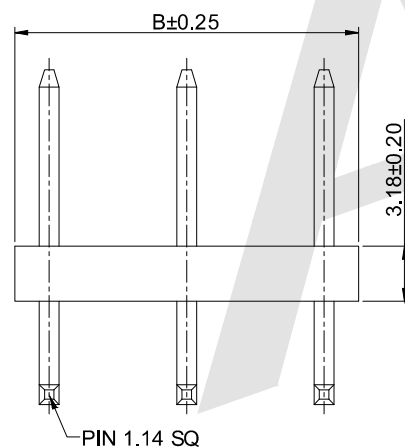

TYPE 1

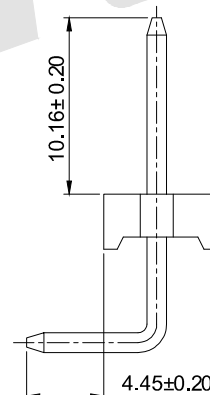

TYPE 2

Ordering Information & Dimensions:

PART NO.	Dimensions	
	A	B
DW3961RA-2P-A	3.96	7.92
DW3961RA-3P-A	7.92	11.88
DW3961RA-4P-A	11.88	15.84
DW3961RA-5P-A	15.84	19.80
DW3961RA-6P-A	19.80	23.76
DW3961RA-7P-A	23.76	27.72
DW3961RA-8P-A	27.72	31.68
DW3961RA-9P-A	31.68	35.64
DW3961RA-10P-A	35.64	39.60
DW3961RA-11P-A	39.60	43.56
DW3961RA-12P-A	43.56	47.52
DW3961RA-13P-A	47.52	51.48
DW3961RA-14P-A	51.48	55.44
DW3961RA-15P-A	55.44	59.40
DW3961RA-16P-A	59.40	63.36
DW3961RA-17P-A	63.36	67.32
DW3961RA-18P-A	67.32	71.28
DW3961RA-19P-A	71.28	75.24
DW3961RA-20P-A	75.24	79.20
DW3961RA-21P-A	79.20	83.16
DW3961RA-22P-A	83.16	87.12
DW3961RA-23P-A	87.12	91.08
DW3961RA-24P-A	91.08	95.04

Unit: mm

Unless Otherwise specified tolerance
 X. ±0.35 X.XX: ±0.20
 X.X: ±0.25 X.XXX: ±0.15



ANTENK ELECTRONICS CO., LTD
[Http://www.antenk.com](http://www.antenk.com)
 E-mail:sales@antenk.com

SCALE: As Shown	UNIT: mm
DRAW Jack Bao	DATE 7/12/2018
CHECK Bob Yang	DATE 7/12/2018

TITLE: 3.96mm pitch 90° Wafer Connector Series

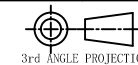

DRAWING NO: DW3961RA-XP-A

PRODUCT NO: DW3961RA-XP-A

REV	DESCRIPTION	DATE
1		
2		
3		
4		
5		