

TO-92 Plastic-Encapsulate Transistors

YZPST-SS8550 TRANSISTOR (PNP)

FEATURES

- Power dissipation
 $P_C : 1\text{ W}$ ($T_a=25^\circ\text{C}$)

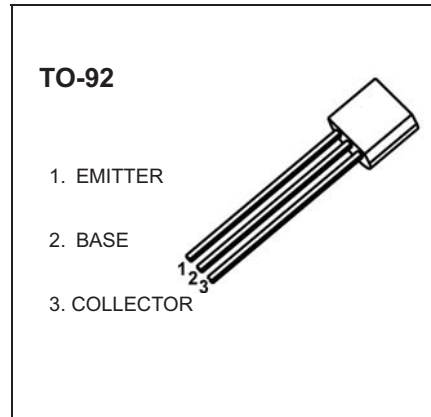

MARKING

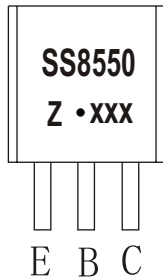

SS8550=Device code
 Solid dot=Green molding compound device,
 if none,the normal device
 Z=Rank of h_{FE} ,
 XXX=Code

Equivalent Circuit

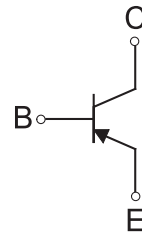

ORDERING INFORMATION

Part Number	Package	Packing Method	Pack Quantity
SS8550	TO-92	Bulk	1000pcs/Bag
SS8550-TA	TO-92	Tape	2000pcs/Box

MAXIMUM RATINGS ($T_a=25^\circ\text{C}$ unless otherwise noted)

Symbol	Parameter	Value	Unit
V_{CBO}	Collector-Base Voltage	-40	V
V_{CEO}	Collector-Emitter Voltage	-25	V
V_{EBO}	Emitter-Base Voltage	-5	V
I_C	Collector Current -Continuous	-1.5	A
P_D	Collector Power Dissipation	1000	mW
$R_{\theta JA}$	Thermal Resistance from Junction to Ambient	125	$^\circ\text{C} / \text{W}$
T_J, T_{stg}	Operation Junction and Storage Temperature Range	-55~+150	$^\circ\text{C}$

ELECTRICAL CHARACTERISTICS

$T_a=25^\circ\text{C}$ unless otherwise specified

Parameter	Symbol	Test conditions	Min	Typ	Max	Unit
Collector-base breakdown voltage	$V_{(BR)CBO}$	$I_C=-100\mu\text{A}$, $I_E=0$	-40			V
Collector-emitter breakdown voltage	$V_{(BR)CEO}$	$I_C=-0.1\text{mA}$, $I_B=0$	-25			V
Emitter-base breakdown voltage	$V_{(BR)EBO}$	$I_E=-100\mu\text{A}$, $I_C=0$	-5			V
Collector cut-off current	I_{CBO}	$V_{CB}=-40\text{V}$, $I_E=0$			-0.1	μA
Emitter cut-off current	I_{CEO}	$V_{CE}=-20\text{V}$, $I_E=0$			-0.1	μA
Emitter cut-off current	I_{EBO}	$V_{EB}=-5\text{V}$, $I_C=0$			-0.1	μA
DC current gain	$h_{FE(1)}$	$V_{CE}=-1\text{V}$, $I_C=-100\text{mA}$	85		400	
	$h_{FE(2)}$	$V_{CE}=-1\text{V}$, $I_C=-800\text{mA}$	40			
Collector-emitter saturation voltage	$V_{CE(sat)}$	$I_C=-800\text{mA}$, $I_B=-80\text{mA}$			-0.5	V
Base-emitter saturation voltage	$V_{BE(sat)}$	$I_C=-800\text{mA}$, $I_B=-80\text{mA}$			-1.2	V
Base-emitter voltage	$V_{BE(on)}$	$V_{CE}=-1\text{V}$, $I_C=-10\text{mA}$			-1	V
Out capacitance	C_{ob}	$V_{CB}=-10\text{V}$, $I_E=0\text{mA}$, $f=1\text{MHz}$			20	pF
Transition frequency	f_T	$V_{CE}=-10\text{V}$, $I_C=-50\text{mA}$, $f=30\text{MHz}$	100			MHz

CLASSIFICATION OF $h_{FE(1)}$

Rank	B	C	D	D3
Range	85-160	120-200	160-300	300-400



Typical Characteristics

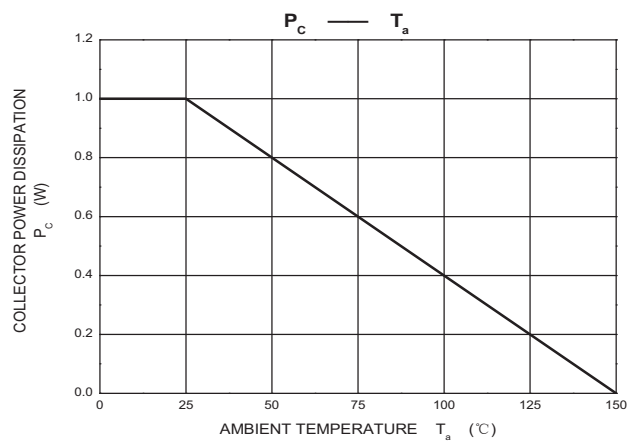
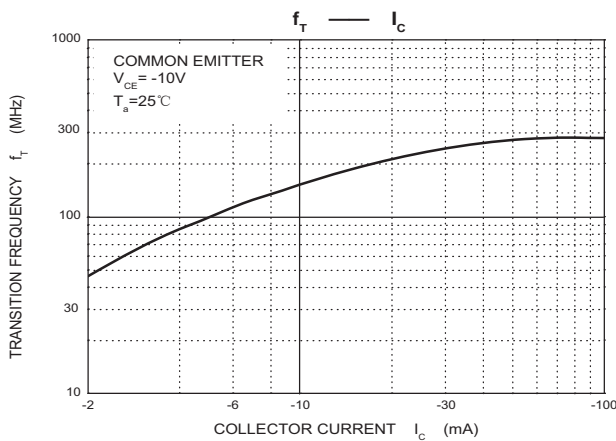
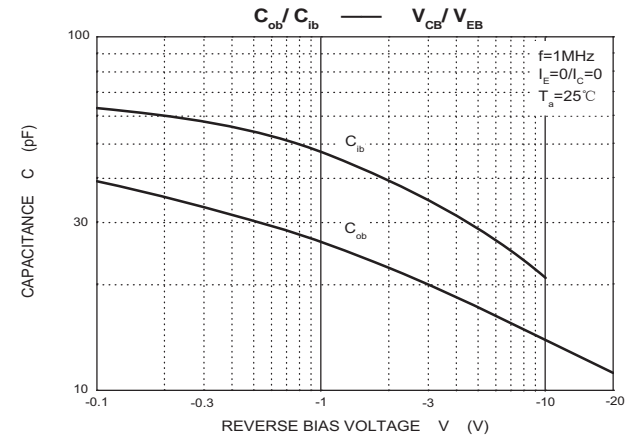
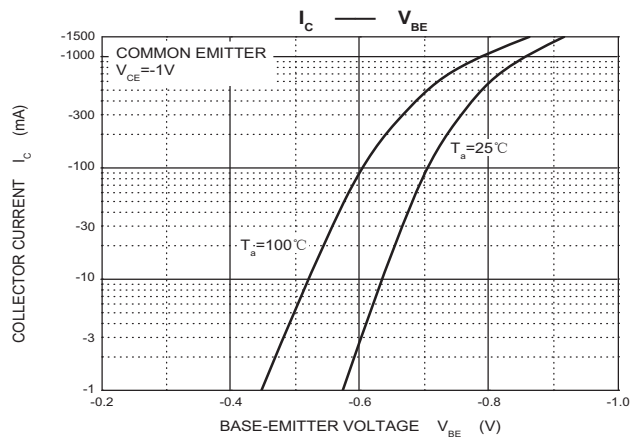
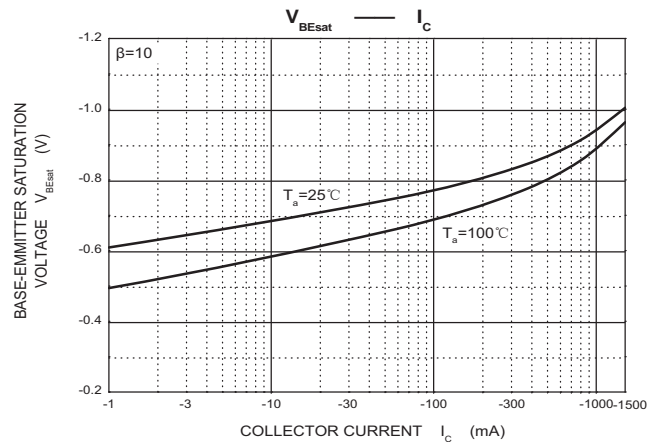
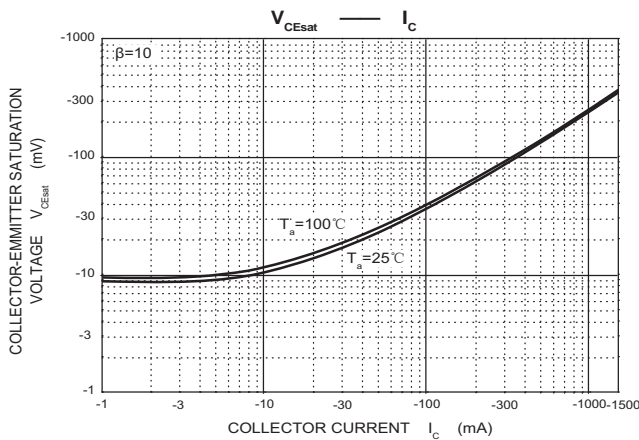
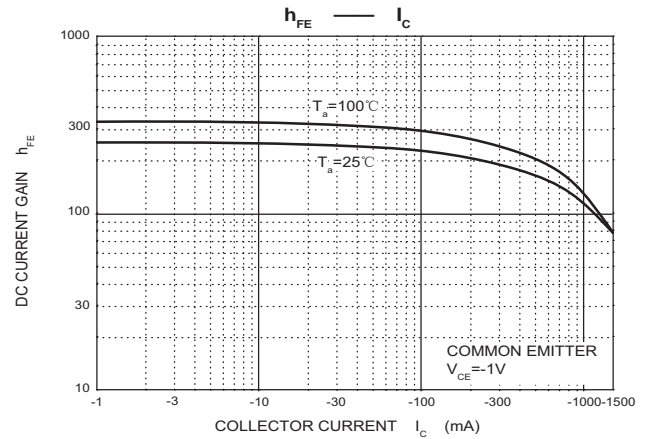
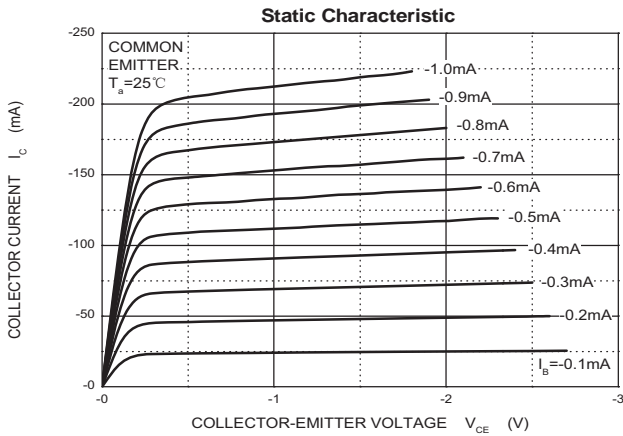

TO-92 Package Outline Dimensions

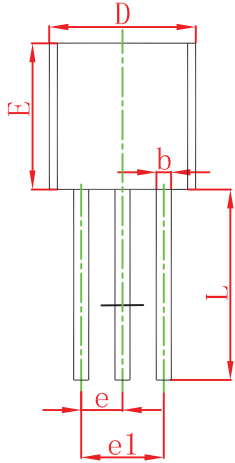
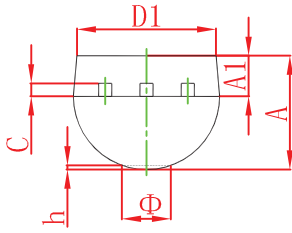

Symbol	Dimensions In Millimeters		Dimensions In Inches	
	Min	Max	Min	Max
A	3.300	3.700	0.130	0.146
A1	1.100	1.400	0.043	0.055
b	0.380	0.550	0.015	0.022
c	0.360	0.510	0.014	0.020
D	4.300	4.700	0.169	0.185
D1	3.430		0.135	
E	4.300	4.700	0.169	0.185
e	1.270 TYP		0.050 TYP	
e1	2.440	2.640	0.096	0.104
L	14.100	14.500	0.555	0.571
Φ		1.600		0.063
h	0.000	0.380	0.000	0.015

TO-92 Suggested Pad Layout

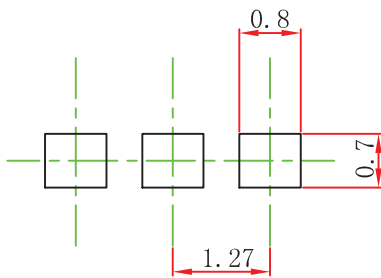

Note:

1. Controlling dimension: in millimeters.
2. General tolerance: $\pm 0.05\text{mm}$.
3. The pad layout is for reference purposes only.

NOTICE

JSCJ reserves the right to make modifications, enhancements, improvements, corrections or other changes without further notice to any product herein. JSCJ does not assume any liability arising out of the application or use of any product described herein.

TO-92 Tape and Reel

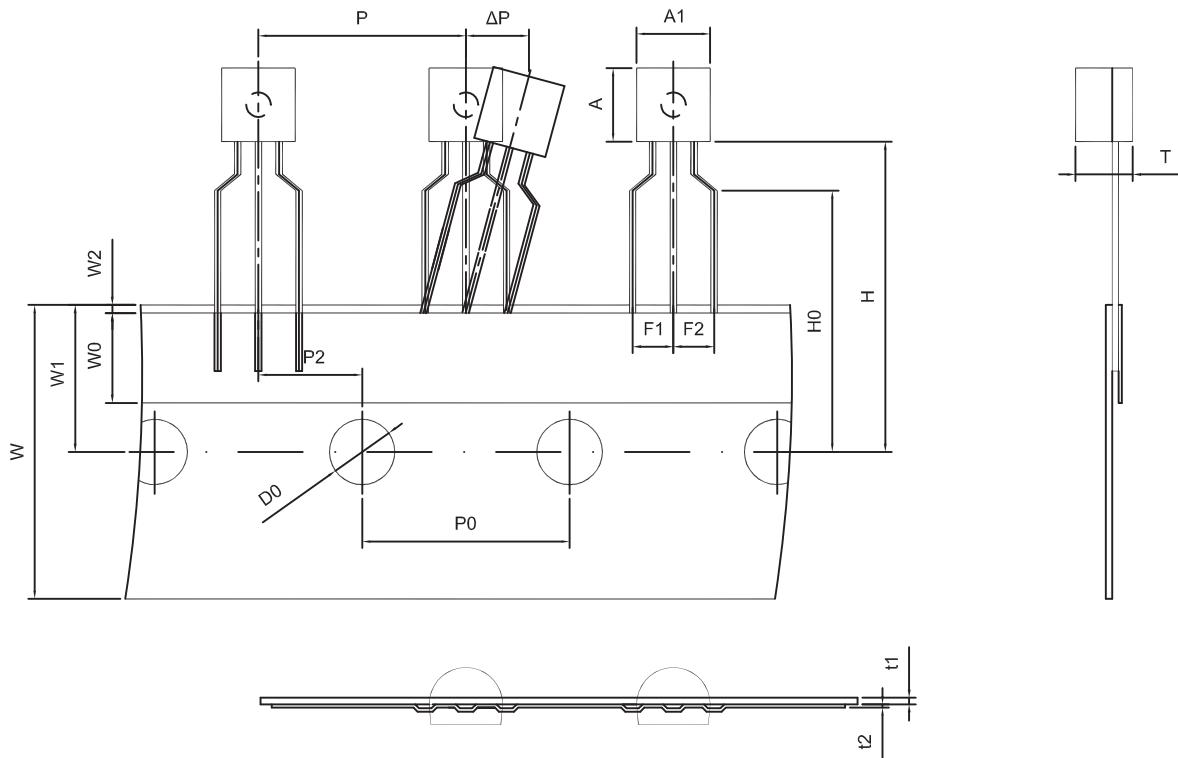

Dimensions are in millimeter

A1	A	T	P	P0	P2	F1	F2	W
4.5	4.5	3.5	12.7	12.7	6.35	2.5	2.5	18.0
W0	W1	W2	H	H0	D0	t1	t2	ΔP
6.0	9.0	1.0 MAX.	19.0	16.0	4.0	0.4	0.2	0

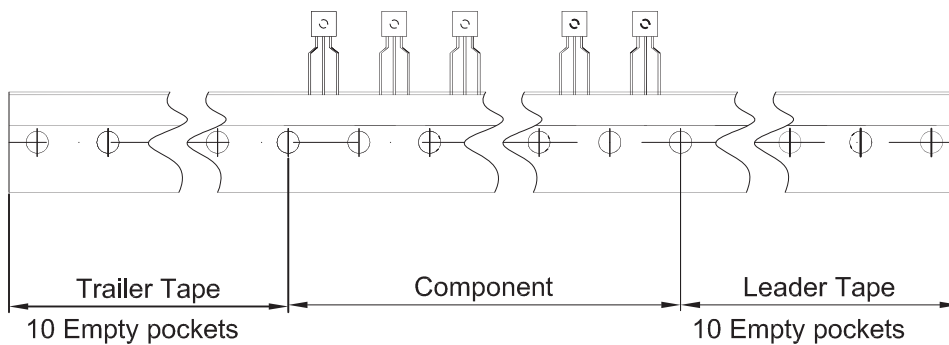

Package	Box	Box Size(mm)	Carton	Carton Size(mm)
TO-92	2000 pcs	333×162×43	20,000 pcs	350×340×250