

P/N: YZPST-SK45UT

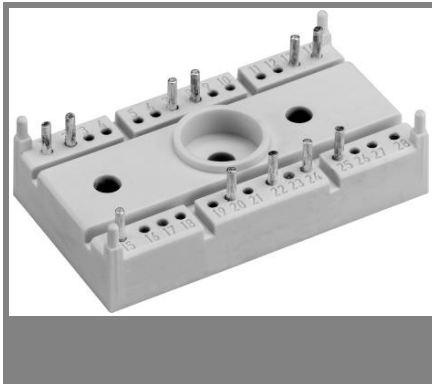

### Antiparallel Thyristor Module

#### Features

- Compact Design
- One screw mounting
- Heat transfer and isolation through direct copper bonded aluminium oxide ceramic (DBC)
- Glass passivated thyristor chips
- Up to 1600V reverse voltage

#### Typical Applications

- Soft starters
- Light control (studios, theaters...)
- Temperature control

$V_{RSM}$ V	$V_{RRM}, V_{DRM}$ V	$I_{RMS} = 47\text{ A (full conduction)}$ ( $T_s = 85\text{ }^\circ\text{C}$ )
900	800	SK 45 UT 08
1300	1200	SK 45 UT 12
1700	1600	SK 45 UT 16

Symbol	Conditions	Values	Units
$I_{RMS}$	W1C ; sin. 180° ; $T_s = 100^\circ\text{C}$	33	A
	W1C ; sin. 180° ; $T_s = 85^\circ\text{C}$	47	A
$I_{TSM}$	$T_{vj} = 25\text{ }^\circ\text{C}$ ; 10 ms	450	A
	$T_{vj} = 125\text{ }^\circ\text{C}$ ; 10 ms	380	A
$i^2t$	$T_{vj} = 25\text{ }^\circ\text{C}$ ; 8,3...10 ms	1000	A <sup>2</sup> s
	$T_{vj} = 125\text{ }^\circ\text{C}$ ; 8,3...10 ms	720	A <sup>2</sup> s
$V_T$	$T_{vj} = 25\text{ }^\circ\text{C}$ , $I_T = 75\text{ A}$	max. 1,9	V
$V_{T(TO)}$	$T_{vj} = 125\text{ }^\circ\text{C}$	max. 1	V
$r_T$	$T_{vj} = 125\text{ }^\circ\text{C}$	max. 10	mΩ
$I_{DD}, I_{RD}$	$T_{vj} = 125\text{ }^\circ\text{C}$ , $V_{RD} = V_{RRM}$	max. 10	mA
$t_{gd}$	$T_{vj} = 25\text{ }^\circ\text{C}$ , $I_G = 1\text{ A}$ ; $di_G/dt = 1\text{ A}/\mu\text{s}$	1	μs
$t_{gr}$	$V_D = 0,67 * V_{DRM}$	2	μs
$(dv/dt)_{cr}$	$T_{vj} = 125\text{ }^\circ\text{C}$	1000	V/μs
$(di/dt)_{cr}$	$T_{vj} = 125\text{ }^\circ\text{C}$ ; $f = 50...60\text{ Hz}$	50	A/μs
$t_q$	$T_{vj} = 125\text{ }^\circ\text{C}$ ; typ.	80	μs
$I_H$	$T_{vj} = 25\text{ }^\circ\text{C}$ ; typ. / max.	80 / 150	mA
$I_L$	$T_{vj} = 25\text{ }^\circ\text{C}$ ; $R_G = 33\text{ }^\circ\Omega$ ; typ. / max.	150 / 300	mA
$V_{GT}$	$T_{vj} = 25\text{ }^\circ\text{C}$ ; d.c.	min. 3	V
$I_{GT}$	$T_{vj} = 25\text{ }^\circ\text{C}$ ; d.c.	min. 100	mA
$V_{GD}$	$T_{vj} = 125\text{ }^\circ\text{C}$ ; d.c.	max. 0,25	V
$I_{GD}$	$T_{vj} = 125\text{ }^\circ\text{C}$ ; d.c.	max. 3	mA
$R_{th(j-s)}$	cont. per thyristor	1,2	K/W
	sin 180° per thyristor	1,24	K/W
$R_{th(j-s)}$	cont. per W1C	0,6	K/W
	sin 180° per W1C	0,62	K/W
$T_{vj}$		-40 ... +125	°C
$T_{stg}$		-40 ... +125	°C
$T_{solder}$	terminals, 10s	260	°C
$V_{isol}$	a. c. 50 Hz; r.m.s.; 1 s / 1 min.	3000 / 2500	V~
$M_s$	Mounting torque to heatsink	2,5	Nm
$M_t$			Nm
$a$			m/s <sup>2</sup>
$m$		30	g
Case		T 13	

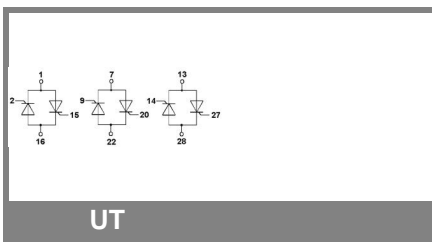

UT

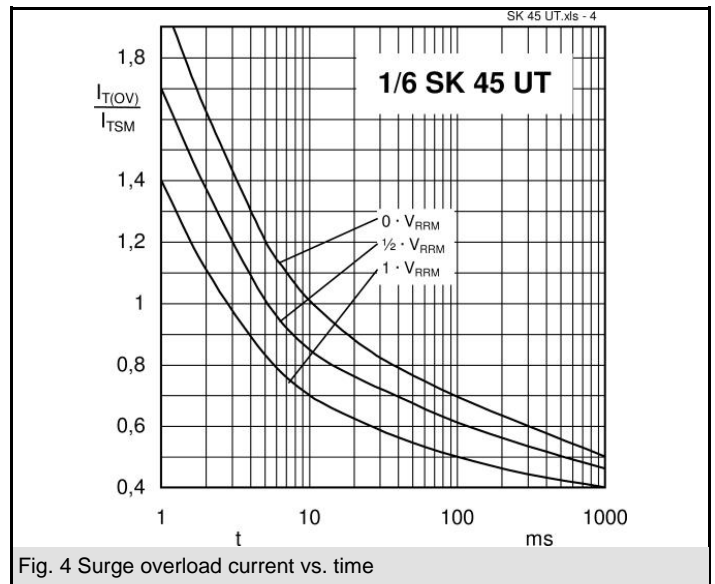
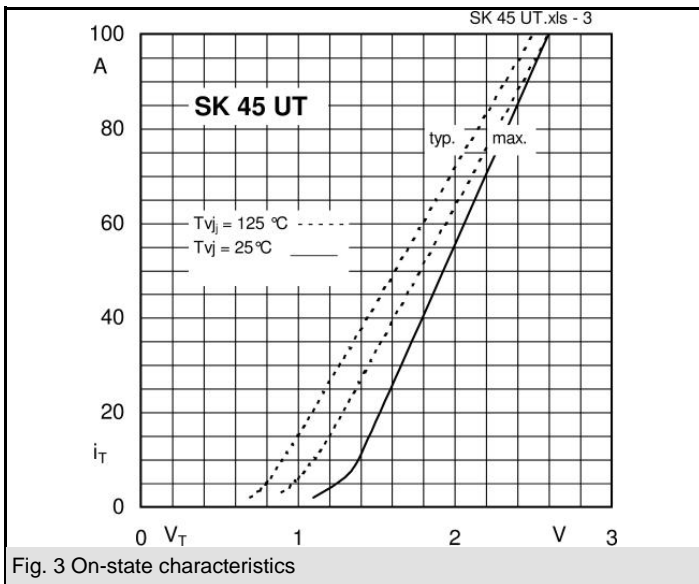
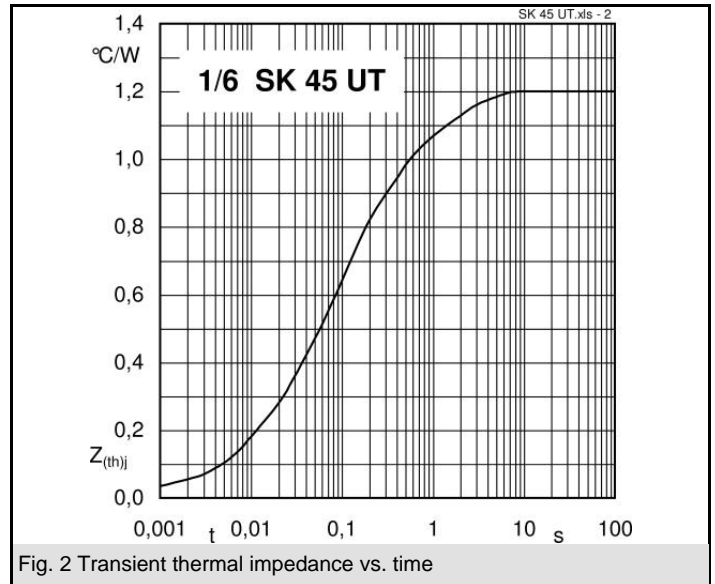
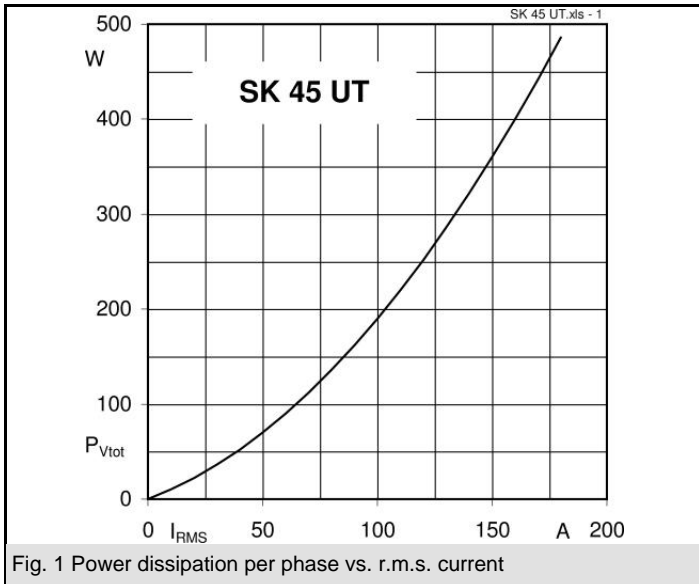

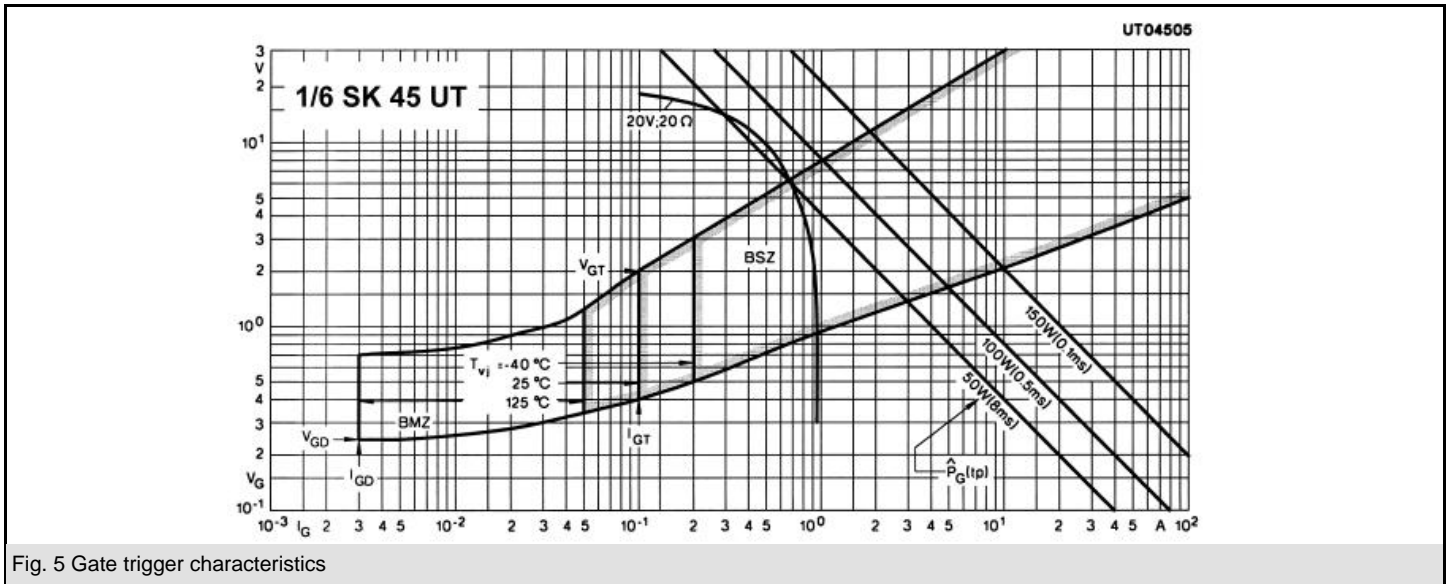
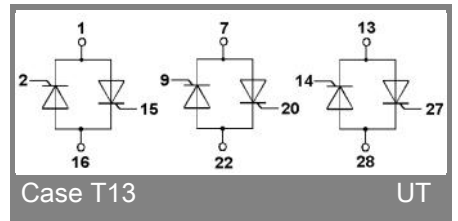
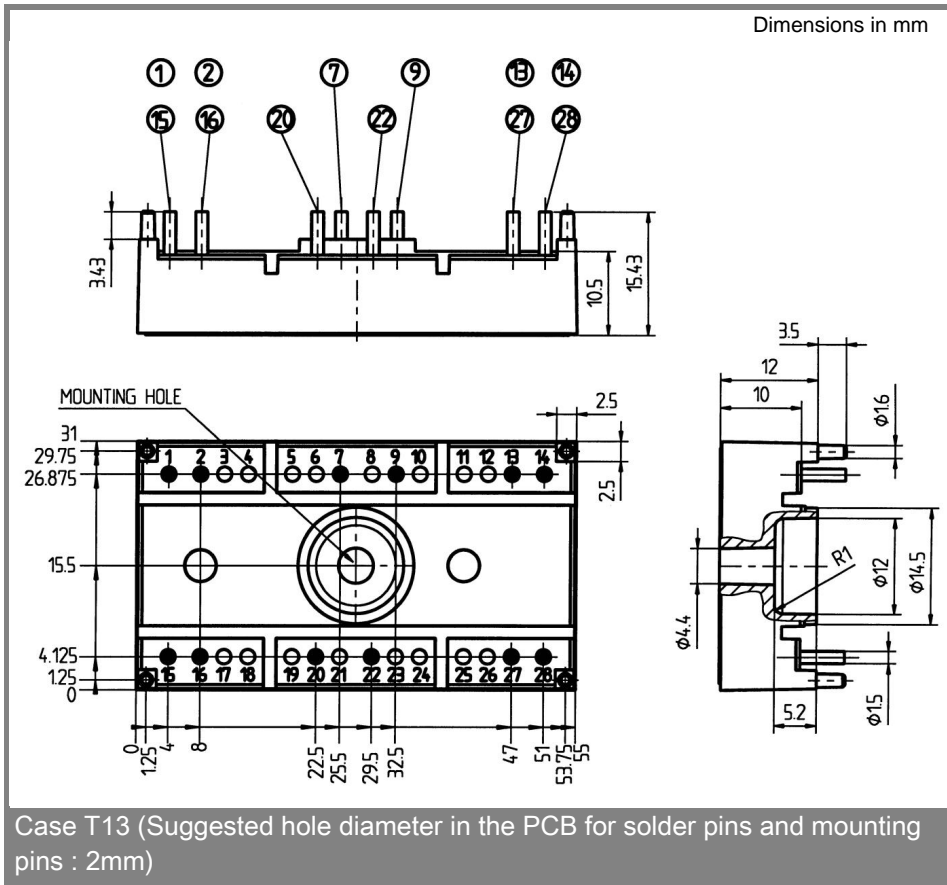

Fig. 5 Gate trigger characteristics



Case T13 (Suggested hole diameter in the PCB for solder pins and mounting pins : 2mm)