

TO-92 Plastic-Encapsulate Transistors

YZPST-BC546 / BC547 / BC548 TRANSISTOR (NPN)

FEATURES

- High Voltage
- Complement to BC556,BC557,BC558

MARKING

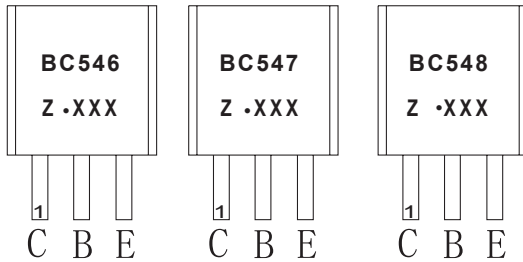

BC546,BC547,BC548=Device code

Solid dot=Green molding compound device, if none,the normal device

Z=Rank of h_{FE}

XXX=Code

TO-92

1. COLLECTOR
2. BASE
3. EMITTER

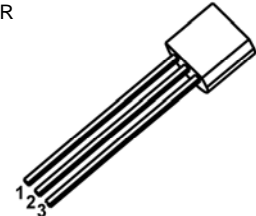

Equivalent Circuit

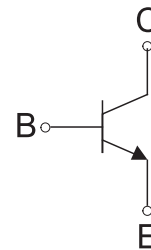

ORDERING INFORMATION

Part Number	Package	Packing Method	Pack Quantity
BC546	TO-92	Bulk	1000pcs/Bag
BC546-TA	TO-92	Tape	2000pcs/Box
BC547	TO-92	Bulk	1000pcs/Bag
BC547-TA	TO-92	Tape	2000pcs/Box
BC548	TO-92	Bulk	1000pcs/Bag
BC548-TA	TO-92	Tape	2000pcs/Box

MAXIMUM RATINGS ($T_a=25^\circ\text{C}$ unless otherwise noted)

Symbol	Parameter	Value	Unit
V_{CBO}	Collector-Base Voltage	BC546	80
		BC547	50
		BC548	30
V_{CEO}	Collector-Emitter Voltage	BC546	65
		BC547	45
		BC548	30
V_{EBO}	Emitter-Base Voltage	BC546	6
		BC547	6
		BC548	5
I_C	Collector Current-Continuous	0.1	A
P_C	Collector Power Dissipation	625	mW
$R_{\theta JA}$	Thermal Resistance from Junction to Ambient	200	$^\circ\text{C}/\text{W}$
T_J, T_{stg}	Operation Junction and Storage Temperature Range	-55~+150	$^\circ\text{C}$

ELECTRICAL CHARACTERISTICS

$T_a=25^\circ\text{C}$ unless otherwise specified

ELECTRICAL CHARACTERISTICS ($T_a=25^\circ\text{C}$ unless otherwise specified)

Parameter	Symbol	Test conditions	Min	Typ	Max	Unit
Collector-base breakdown voltage	BC546	$I_C=0.1\text{mA}, I_E=0$	80			V
	BC547		50			
	BC548		30			
Collector-emitter breakdown voltage	BC546	$I_C=1\text{mA}, I_B=0$	65			V
	BC547		45			
	BC548		30			
Emitter-base breakdown voltage	BC546	$I_E=10\mu\text{A}, I_C=0$	6			V
	BC547		6			
	BC548		5			
Collector cut-off current	BC546	I_{CBO}	$V_{CB}=70\text{V}, I_E=0$		0.1	μA
	BC547		$V_{CB}=50\text{V}, I_E=0$		0.1	μA
	BC548		$V_{CB}=30\text{V}, I_E=0$		0.1	μA
Collector cut-off current	BC546	I_{CEO}	$V_{CE}=60\text{V}, I_B=0$		0.1	μA
	BC547		$V_{CE}=45\text{V}, I_B=0$		0.1	μA
	BC548		$V_{CE}=30\text{V}, I_B=0$		0.1	μA
Emitter cut-off current	I_{EBO}	$V_{EB}=5\text{V}, I_C=0$			0.1	μA
DC current gain	h_{FE}^*	$V_{CE}=5\text{V}, I_C=2\text{mA}$	110		800	
Collector-emitter saturation voltage	$V_{CE(sat)}$	$I_C=100\text{mA}, I_B=5\text{mA}$			0.3	V
Base-emitter saturation voltage	$V_{BE(sat)}$	$I_C=100\text{mA}, I_B=5\text{mA}$			1.1	V
Base-emitter voltage	V_{BE}	$V_{CE}=5\text{V}, I_C=2\text{mA}$	0.58		0.7	V
		$V_{CE}=5\text{V}, I_C=10\text{mA}$			0.75	V
Collector output capacitance	C_{ob}	$V_{CB}=10\text{V}, I_E=0, f=1\text{MHz}$			4.5	pF
Transition frequency	f_T	$V_{CE}=5\text{V}, I_C=10\text{mA}, f=100\text{MHz}$	150			MH

CLASSIFICATION of h_{FE}

RANK	A	B	C
RANGE	110-220	200-450	420-800

TO-92 Package Outline Dimensions

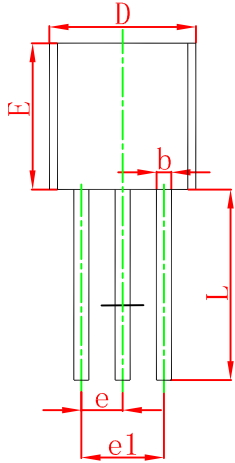
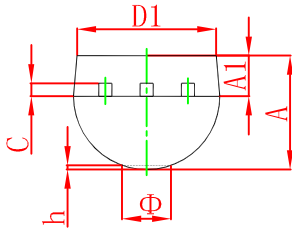

Symbol	Dimensions In Millimeters		Dimensions In Inches	
	Min	Max	Min	Max
A	3.300	3.700	0.130	0.146
A1	1.100	1.400	0.043	0.055
b	0.380	0.550	0.015	0.022
c	0.360	0.510	0.014	0.020
D	4.300	4.700	0.169	0.185
D1	3.430		0.135	
E	4.300	4.700	0.169	0.185
e	1.270 TYP		0.050 TYP	
e1	2.440	2.640	0.096	0.104
L	14.100	14.500	0.555	0.571
Φ		1.600		0.063
h	0.000	0.380	0.000	0.015

TO-92 Suggested Pad Layout

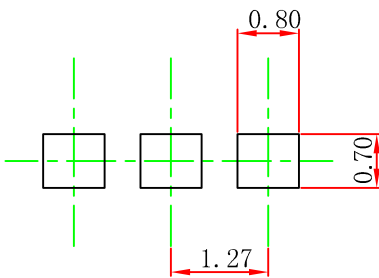

Note:

1. Controlling dimension: in millimeters.
2. General tolerance: $\pm 0.05\text{mm}$.
3. The pad layout is for reference purposes only.

NOTICE

JSCJ reserves the right to make modifications, enhancements, improvements, corrections or other changes without further notice to any product herein. JSCJ does not assume any liability arising out of the application or use of any product described herein.

TO-92 PACKAGE TAPING DIMENSION

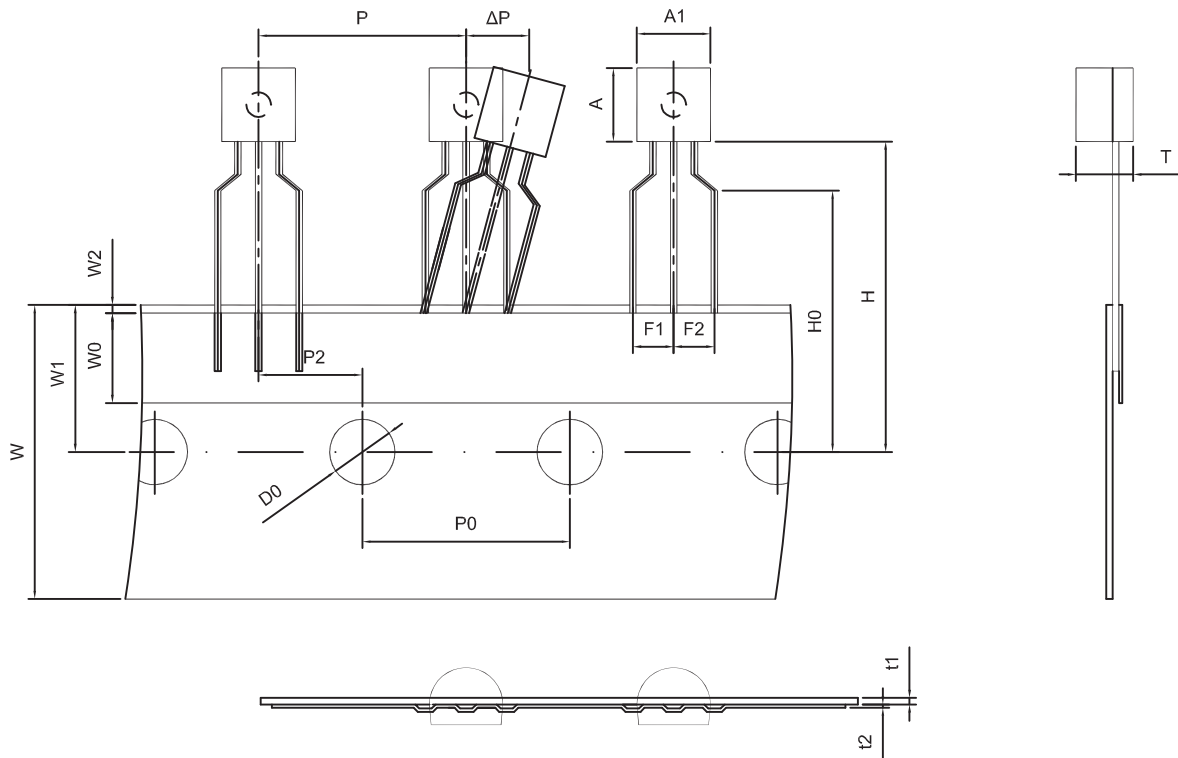

Dimiensions are in millimeter

A1	A	T	P	P0	P2	F1	F2	W
4.5	4.5	3.5	12.7	12.7	6.35	2.5	2.5	18.0
W0	W1	W2	H	H0	D0	t1	t2	ΔP
6.0	9.0	1.0 MAX.	19.0	16.0	4.0	0.4	0.2	0

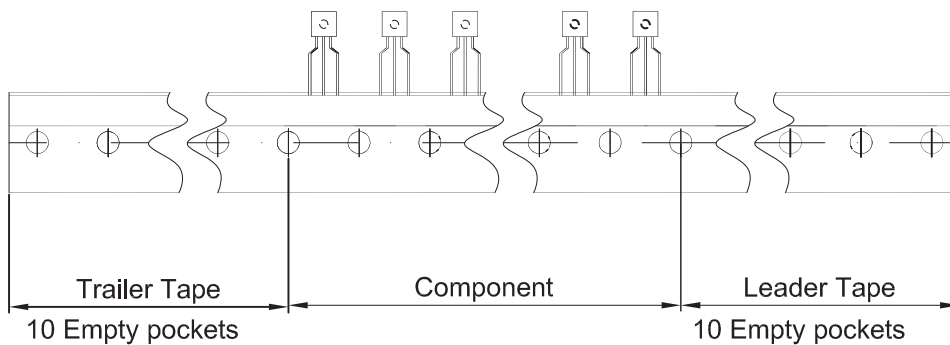

Package	Box	Box Size(mm)	Carton	Carton Size(mm)
TO-92	2000 pcs	333×162×43	20,000 pcs	350×340×250