

Trumony Aluminum Limited

—Trust In Harmony

We care what our clients care

Contact Information:

Ms.Cindy Yang
Phone .: +8618021060306 (WhatsApp)
Email: service2@trumony.com



About us

Trumony Aluminum Limited

Trumony=Trust in Harmony

we care what our clients care.

Trumony Aluminum Limited is a professional supplier for aluminum materials. We were established in 2006, by the constant efforts for more than ten years, we have become one of the global leading and most specialized suppliers in the market of automobile parts, heat exchanges, cables, electronics, and so on.



Products



Heat exchange market

- 1、 Automobile heat exchange (Radiator, Condenser, CAC, Evaporator, Heater, Water cooling plate)
- 2、 Industrial heat exchange (Air-cooling tower, G-type finned tube, HVAC, Cold-chain transport)
- 3、 Household heat exchange (Air-conditioner, Refrigerator)



Automobile parts market

- 1、 Four doors, two covers, roof skinning
- 2、 Engine heat shield
- 3、 Panels, leaf plates
- 4、 Internal stamping
- 5、 Aluminum alloy plate
- 6、 Battery Cooling



Electronic & Cable market

- 1、 Electronics housings
- 2、 Electronics borders
- 3、 Electronics internal supports
- 4、 Electronics base board
- 5、 Other stamping, CNC parts
- 6、 RF cable armor
- 7、 EHV cable armor
- 8、 Medium and low voltage cable armor
- 9、 Coaxial cable shielding

Products

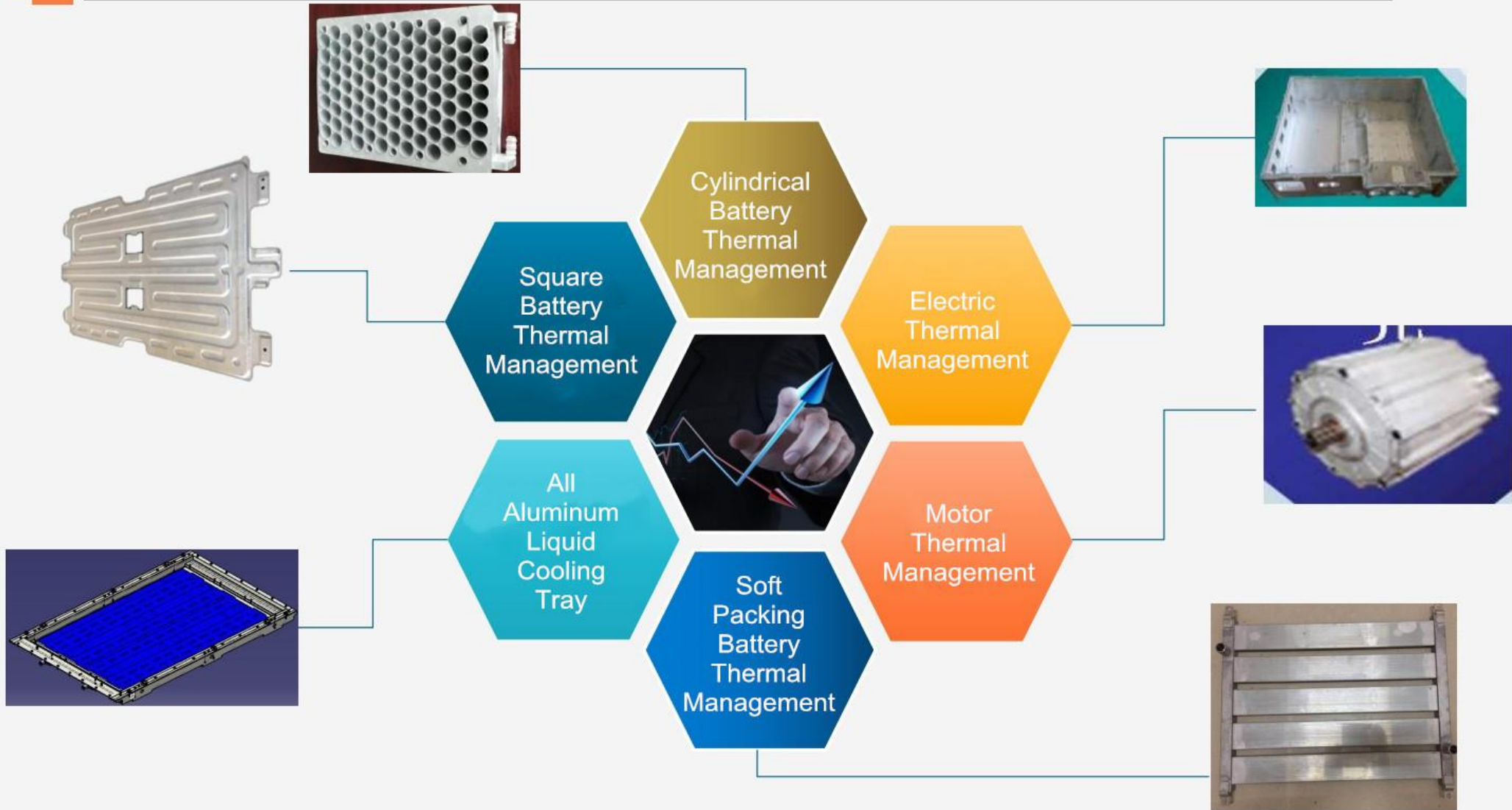

Products

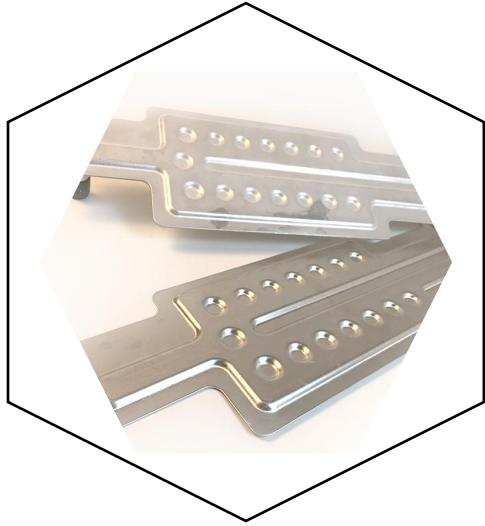

**Water Cooling
Plate**

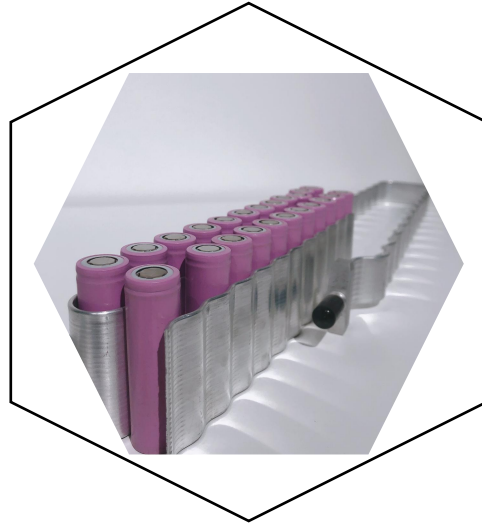

**Serpentine Cooling
Tube**

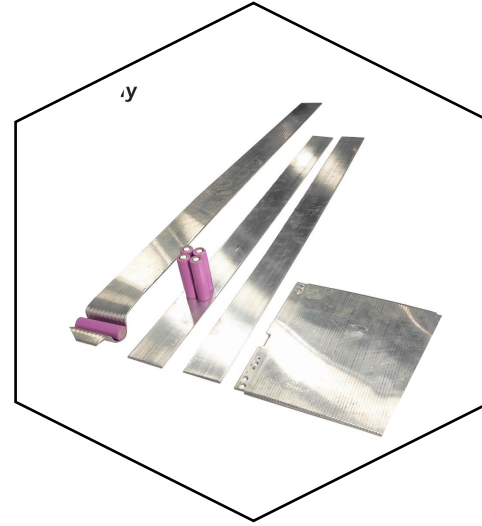

**Vapor Chamber
(VC)**



**Roll-Bonded
Panels**

Water Cooling Plate

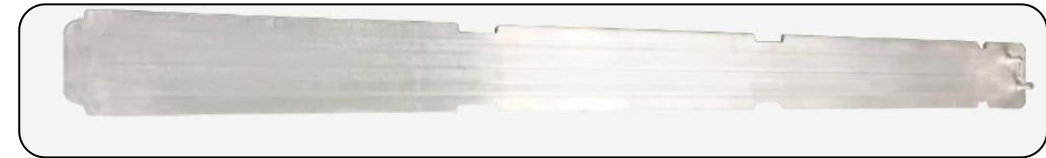
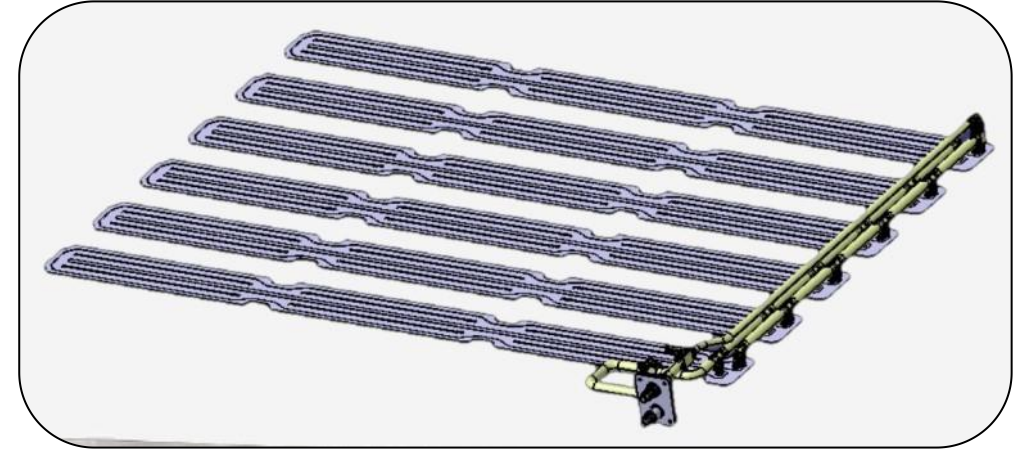
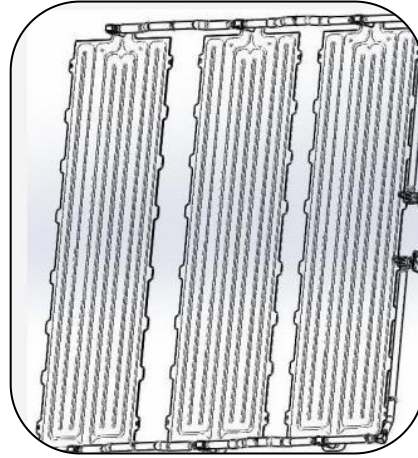
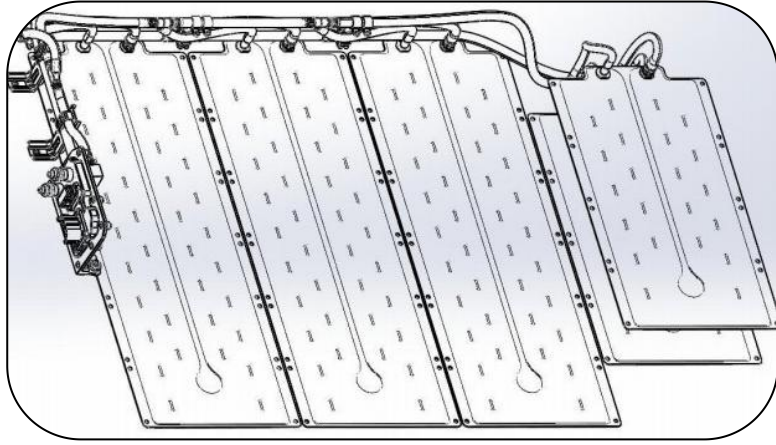

Water Cooling Plate

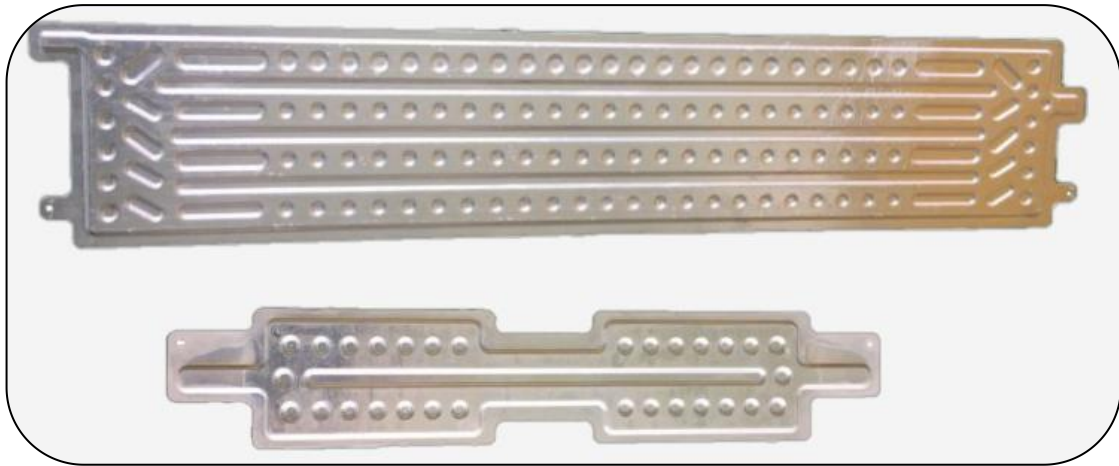
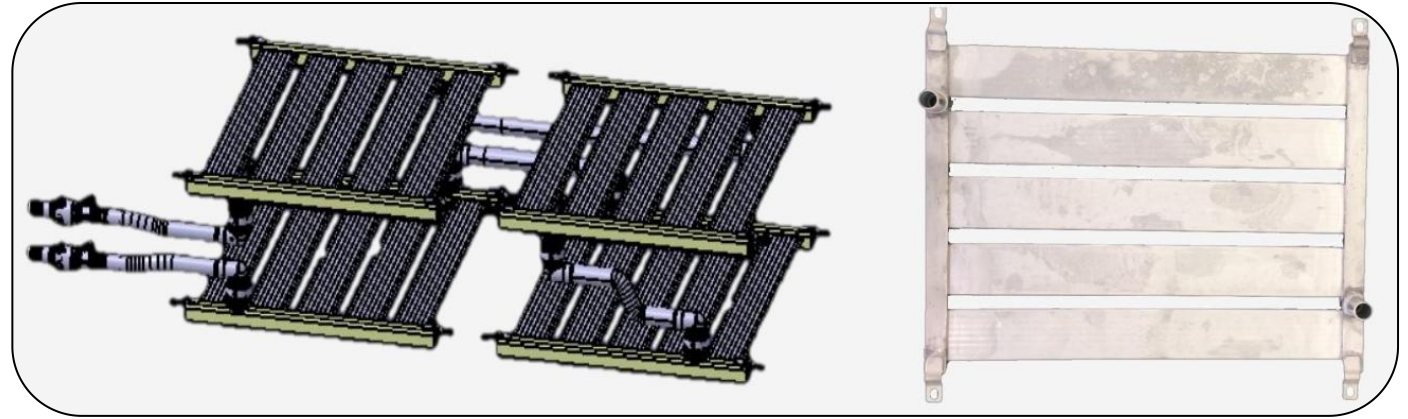
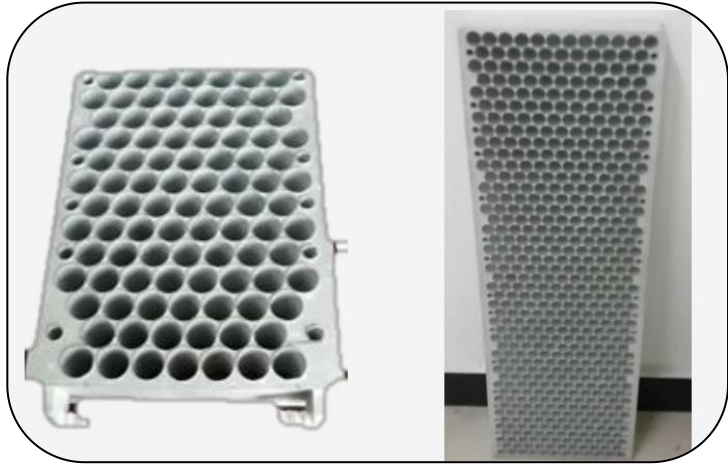

Water Cooling Plate

Fully Automatic Brazing Line Continuously



CNC Machines



Hydraulic Pressing Machine



Ultrasonic Cleaning Machine



Vacuum Helium Detection System

Automatic Parallel Flow Preloader



CNC Cutting Machine



Automatic Welding Spray System



Serpentine Cooling Tube

1

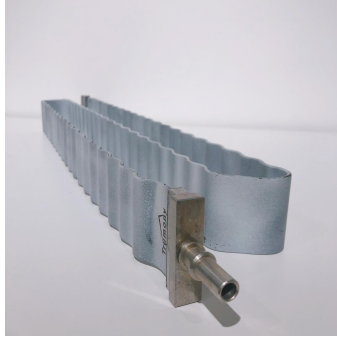

- Milled snake cooling tube with Logo

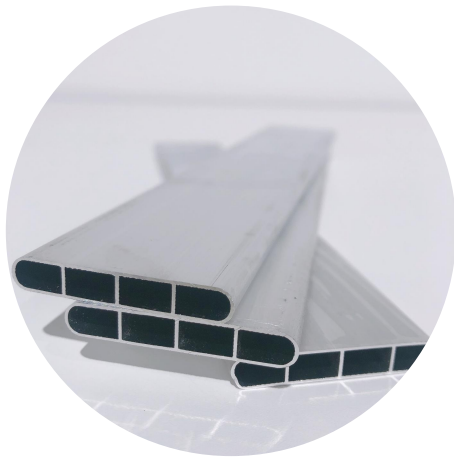

2



- Black coating tube

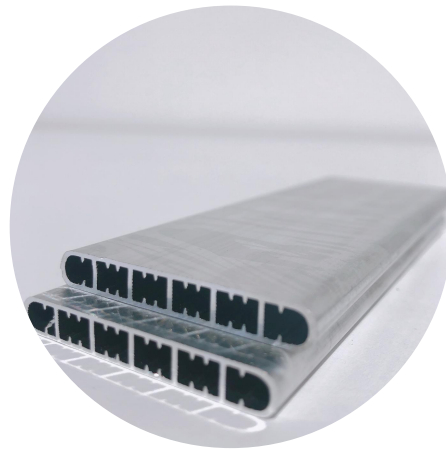

3

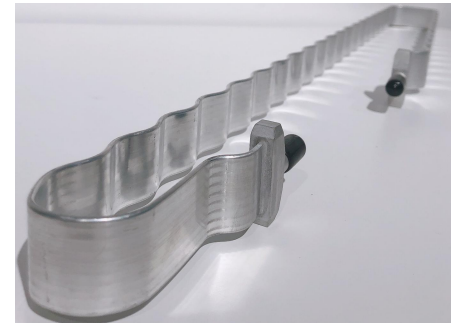

- Shiny aluminum tube

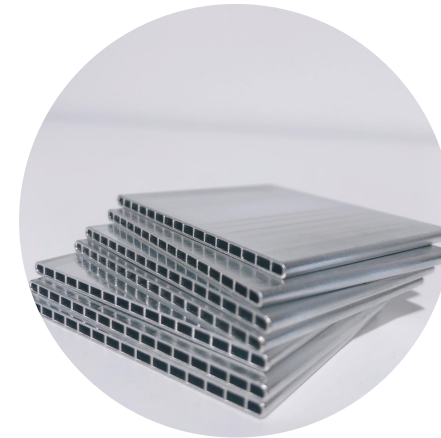

Vapor Chamber (VC)

Aluminum vapor chamber are widely used for heat exchanger or heat collection. Such as solar panel, solar energy collector,,photovoltaic power generation collector,superconducting plate, smoking plate abd temperature niforming plate.

Vapor Chamber Heatsink are constructed from sealed aluminium plates and filled with a small amount of fluid such as de-ionized water that allows heat to be rapidly dispersed away from the source. Inside the chamber resides an internal support structure to prevent the buckling of chamber walls.



Classified formally as a heat pipe, a vapor chamber is one of the best heat spreading options at the base of a heatsink; and typically used for high power devices.

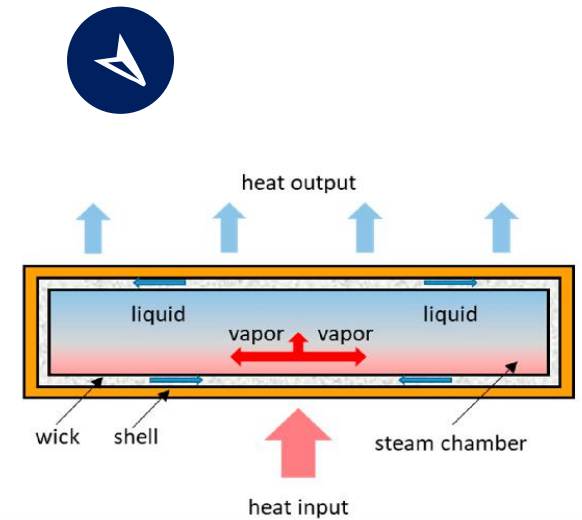

Roll-Bonded Panels

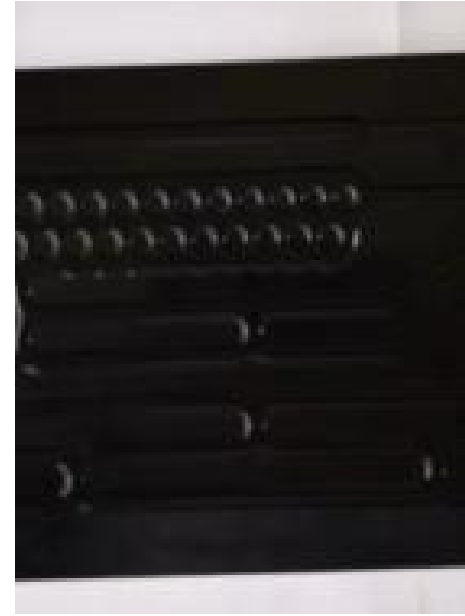
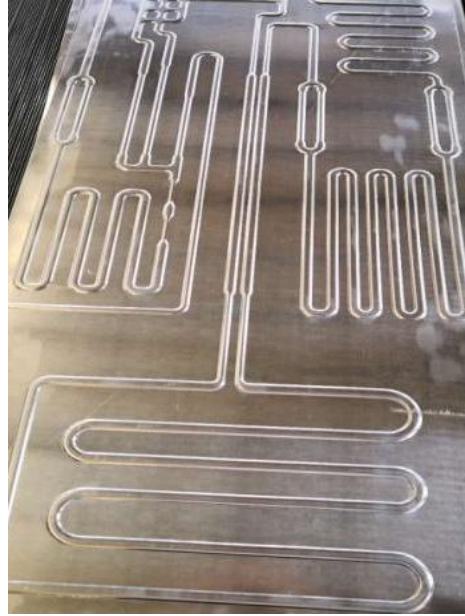

Roll-Bonded Panels



Our Advantages

Tooling development

We do it in house, so we can make initial testing prompt and accurate.

Assistance in parts design

We have experienced engineer team, they can provide professional suggestions regarding feasibility of carrying out new designs.

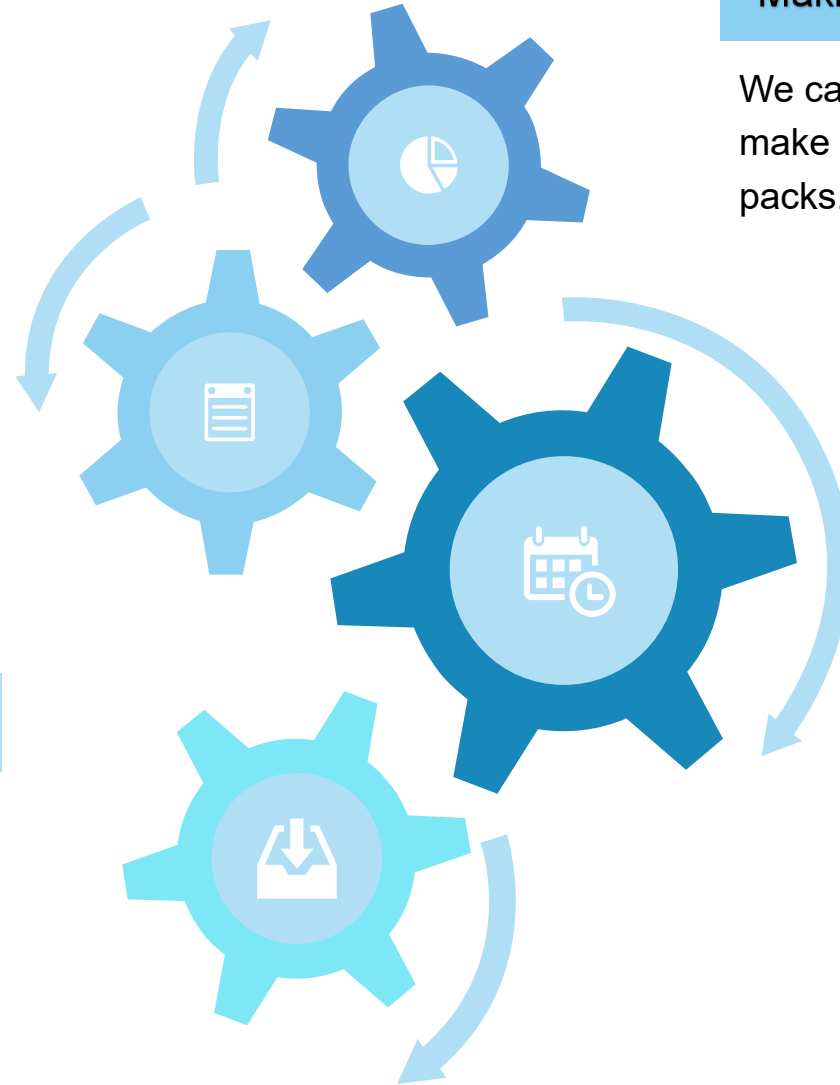

Making all kinds of heat exchangers

We can do customized shape, to make the parts fit into different packs.

One station service

We can do heat exchangers, as well as its related insulation and silicon pad. So client can get integrated solution.

THANKS

谢 谢 聆 听

Contact Information:

Ms.Cindy Yang

Phone .: +8618021060306 (WhatsApp)

Email: service2@trumony.com

