



# 产品规格书

## PRODUCT SPECIFICATION

客户名称 CUSTOMER: \_\_\_\_\_

产品型号 MODEL: MLT5020-12A /MLT-5020

客户型号 USER'S MODEL: \_\_\_\_\_

日期 DATE: 2020-2-25

江苏华能电子有限公司			客户回签		
HUAWHA			CUSTOMER		
SERVE RATIVITY			CUSTOMER RATIGY		
拟制	审核	批准	检验	审核	批准
REPORT	CHECKED	APPROVED	TEST	CHECKED	APPROVED
唐华萍	工稿萍用章	张长华			

江苏华能电子有限公司

JIANGSU HUAWHA ELECTRONICS CO.,LTD

地址: 江苏省泰州市兴化市陈堡镇工业园区

ADD:Chenbao Industrial Park, Chenbao Town, Xinghua,Taizhou City, Jiangsu China.

电话 [TEL:0523-83710666](tel:0523-83710666) 传真 FAX:0523-83724866

网址: [www.huawha.com](http://www.huawha.com) 邮箱 E-mail:

**1.基本规格/General specification**

项目/Item		规格/Spec	条件/Condition
1	额定电压 Rated voltage	3.0Vo-p	
2	工作电压 Operation voltage	2~4Vo-p	
3	声压 Sound Pressure Level=SPL	Min 75dB	测试环境：标准状态，标准驱动电路， 额定电压 测试距离：0.1m Standard State,Standard Drive Circuit. Rated voltage,Distance at 0.1m
4	电流 current	Max100mA	
5	振荡频率 Oscillation frequency	4000Hz	
6	电阻 Coil Resistance	12 ± 2 Ω	
7	工作温度范围 Operating Temperature	-20~+70℃	声压 ≥85dB SPL ≥85dB
8	保存温度范围 Storage temperature	-30~+85℃	
9	外部尺寸 Externals size (mm)	5.2*5.2*2	参阅附图 Refer to the attached drawing
10	重量 Mass	0.5g	
11	材质 Housing Material	LCP	

**2.电气和声学测试条件/Electrical And Acoustical Measuring Condition**

**驱动电路/Recommended Driving Circuit**

**设置 Recommended Setting**

Resonant frequency, 1/2 duty cycle. Square wave.  
Signal amplitude should be large enough to saturate the transistor.

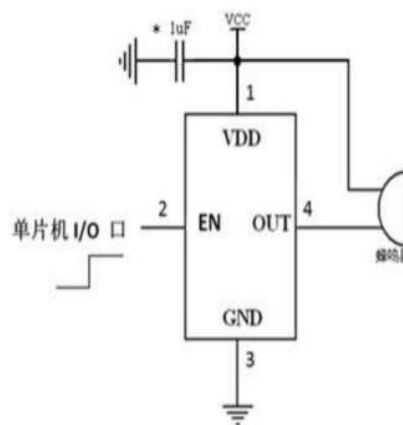
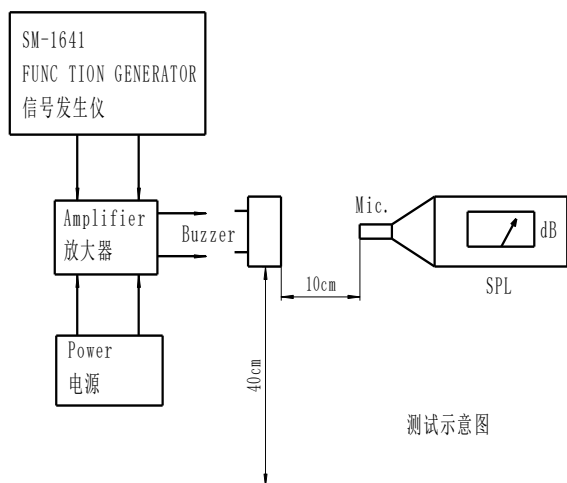

注：\*建议在芯片电源输入端增加1uF电源滤波电容。

**3.可靠性测试/Reliability Test**

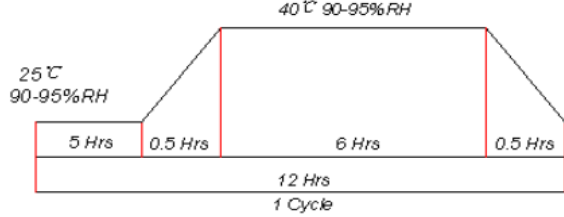
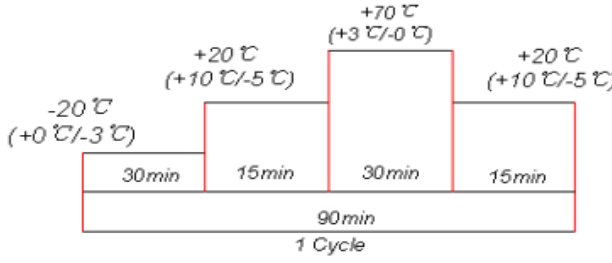
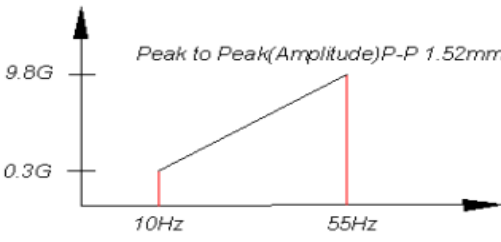
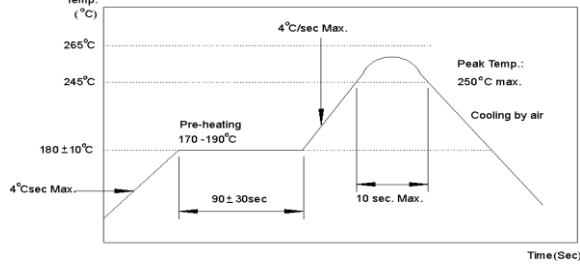
	项目 ITEM	测试方法 TEST
1	高温试验 High Temperature Test	在+80℃±2℃储存温度下存放 96 小时，恢复 2 小时后测试 After being placed in a chamber with +80±2℃ for 96 hours and then being placed in normal condition for 2 hours
2	低温试验 Low Temperature Test	在-20℃±2℃储存温度下存放 96 小时，恢复 2 小时后测试 After being placed in a chamber with -20±2℃ for 96 hours and then being placed in normal condition for 2 hours
3	恒定湿热试验 Humidity Test	 <p>The diagram shows a humidity test cycle. It starts at 25°C with 90-95% RH for 5 hours. Then, it ramps up to 40°C with 90-95% RH over 0.5 hours. It remains at 40°C with 90-95% RH for 6 hours. Finally, it ramps down to 25°C with 90-95% RH over 0.5 hours. The total duration of one cycle is 12 hours.</p>
4	温度变化试验 Temperature Cycle Test	 <p>The diagram shows a temperature cycle test. It starts at -20°C with a range of +0°C/-3°C for 30 minutes. It then ramps up to +20°C with a range of +10°C/-5°C over 15 minutes. It remains at +20°C for 30 minutes. It then ramps up to +70°C with a range of +3°C/-0°C over 30 minutes. It remains at +70°C for 15 minutes. Finally, it ramps down to +20°C with a range of +10°C/-5°C over 15 minutes. The total duration of one cycle is 90 minutes.</p>
5	振动试验 Vibration Test	 <p>The diagram shows a vibration test profile. The vertical axis represents acceleration in G, with markers at 0.3G and 9.8G. The horizontal axis represents frequency in Hz, with markers at 10Hz and 55Hz. The profile shows a constant acceleration of 0.3G from 10Hz to 55Hz. From 55Hz, the acceleration increases linearly to 9.8G. The peak-to-peak amplitude is labeled as P-P 1.52mm.</p>
6	跌落试验 Drop Test	70cm 高自由掉落到 40mm 的木板上，每个方向三次 Drop on a hard wood board of 40mm thick, any directions, three times, at the height of 70cm
7	插针的抗拉强度试验 Terminal Strength Pulling Test	插针承受 1.0kg 拉力，负荷时间 5s The force 5 seconds of 1.0kg is applied to each terminal.
8	可焊性试验 Solder ability Test	焊锡温度 255±5℃，浸润时间为 3±0.5s，试验后目测产品情况 Lead terminals are immersed in rosin for 5 seconds and then immersed in solder bath of 255±5℃ for 3±0.5 seconds.
9	回流焊测试 Soldering Test	 <p>The diagram shows a soldering test temperature profile. The vertical axis is Temperature (°C) with markers at 180±10°C, 245°C, and 265°C. The horizontal axis is Time (Sec). The profile starts with a pre-heating phase at 170-190°C for 90±30 seconds. The heating rate is 4°C/sec Max. The temperature then rises to a peak of 260°C max. The cooling rate is 4°C/sec Max. The cooling phase is labeled 'Cooling by air' and has a duration of 10 sec. Max.</p>

4.尺寸图 Dimension

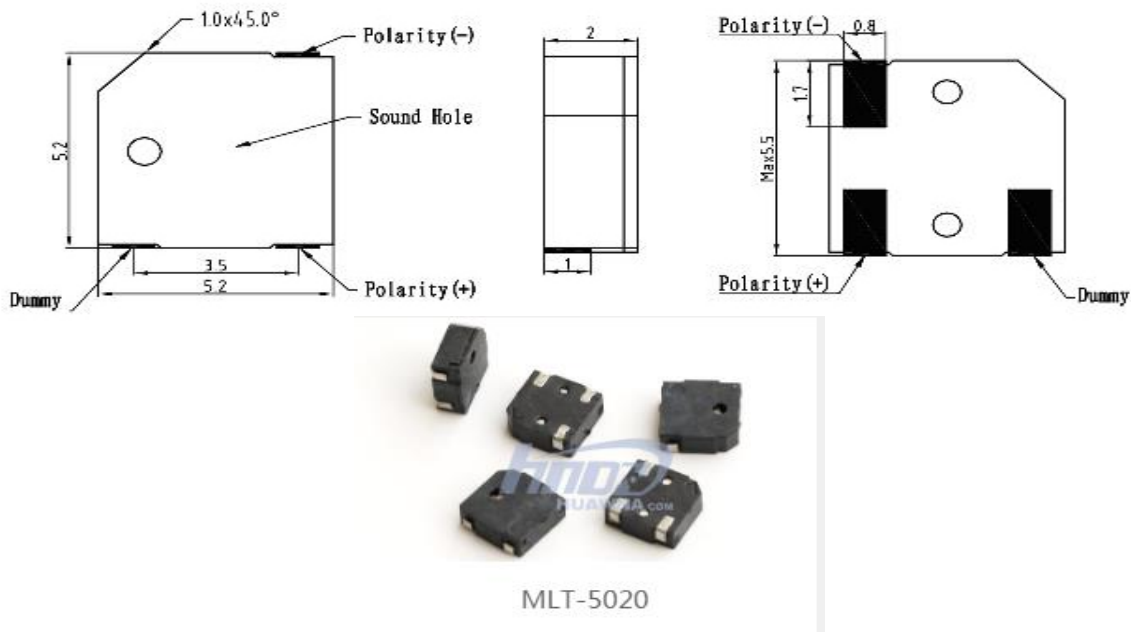

\*Unit: mm; Tolerance: ± 0.3mm Except Specified

\*Housing Material: Black LCP

5.频率响应/Frequency Response

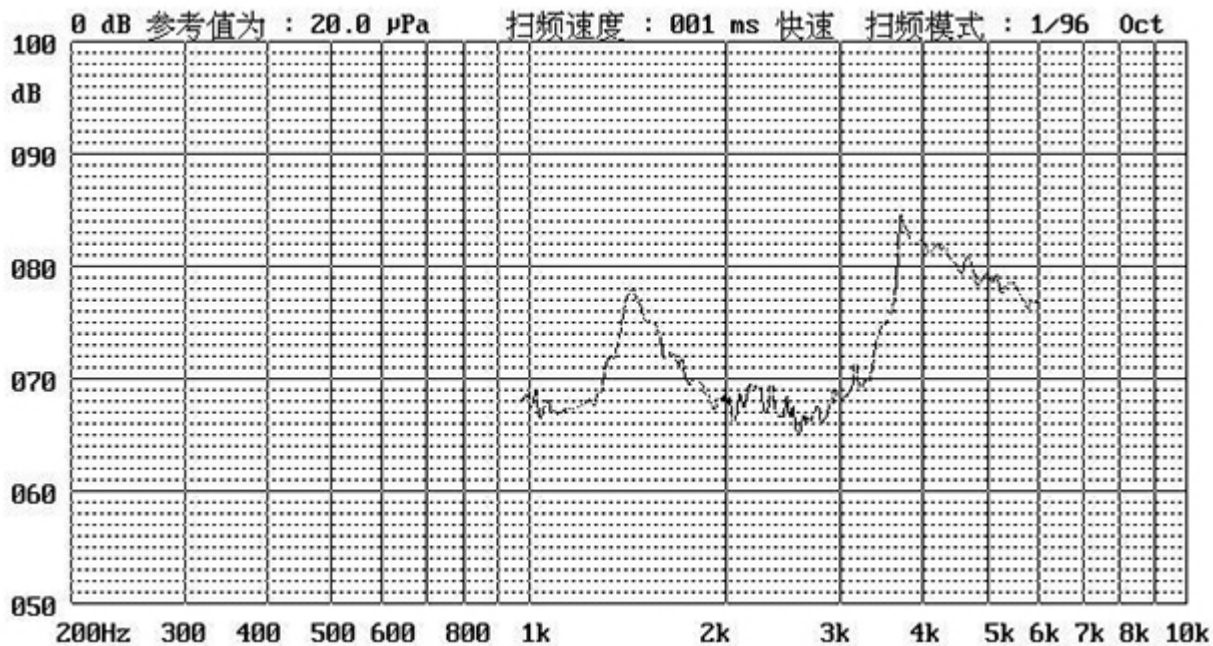

3.0Vo-p 50% duty Square wave, 10cm

6.包装方式/Packing

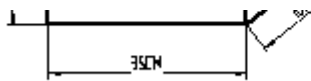
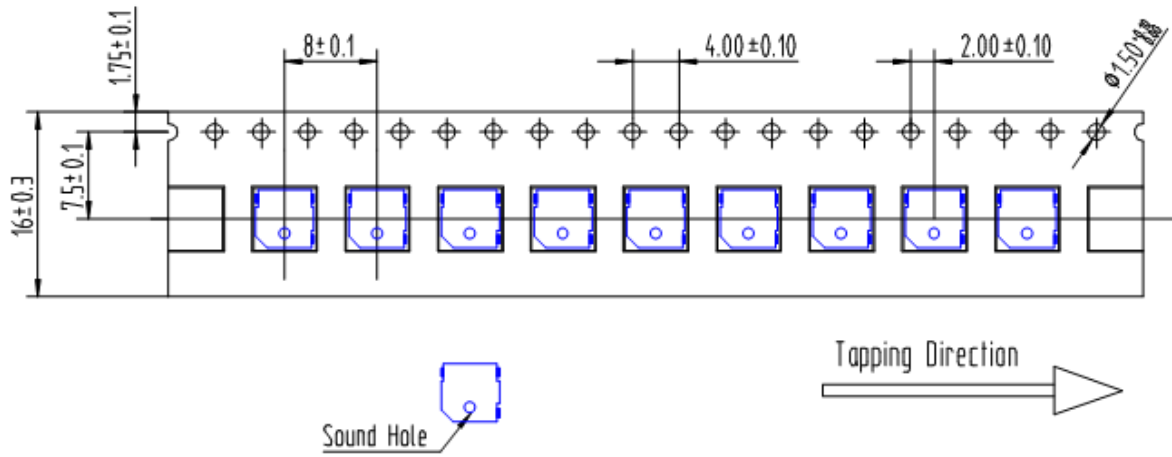

Label content  
1 Reel/Inside box  
134\*34\*35 CM

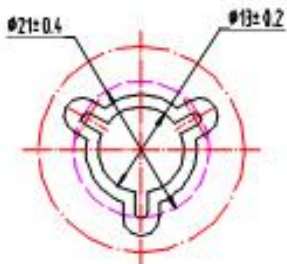

DETAIL: A  
SCALE 8:1

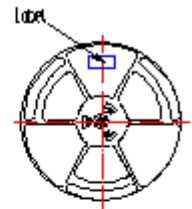
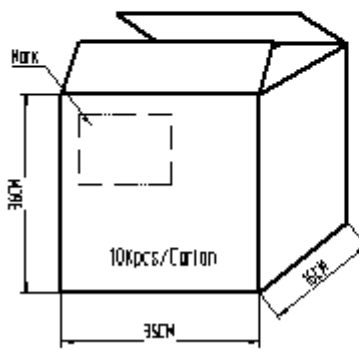
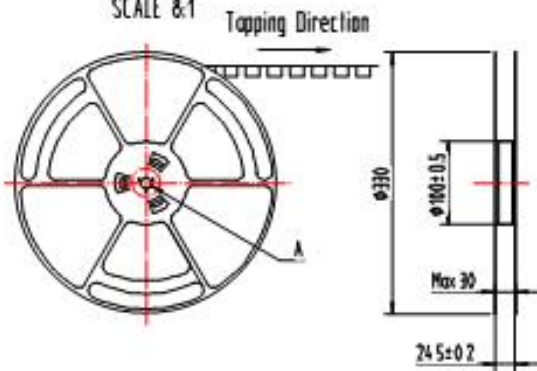

Inside box



Label content  
1 Reel/Inside box  
134\*34\*35 CM