

第十一章 Chapter 11

D-SUB 连接器 Connector



11.1



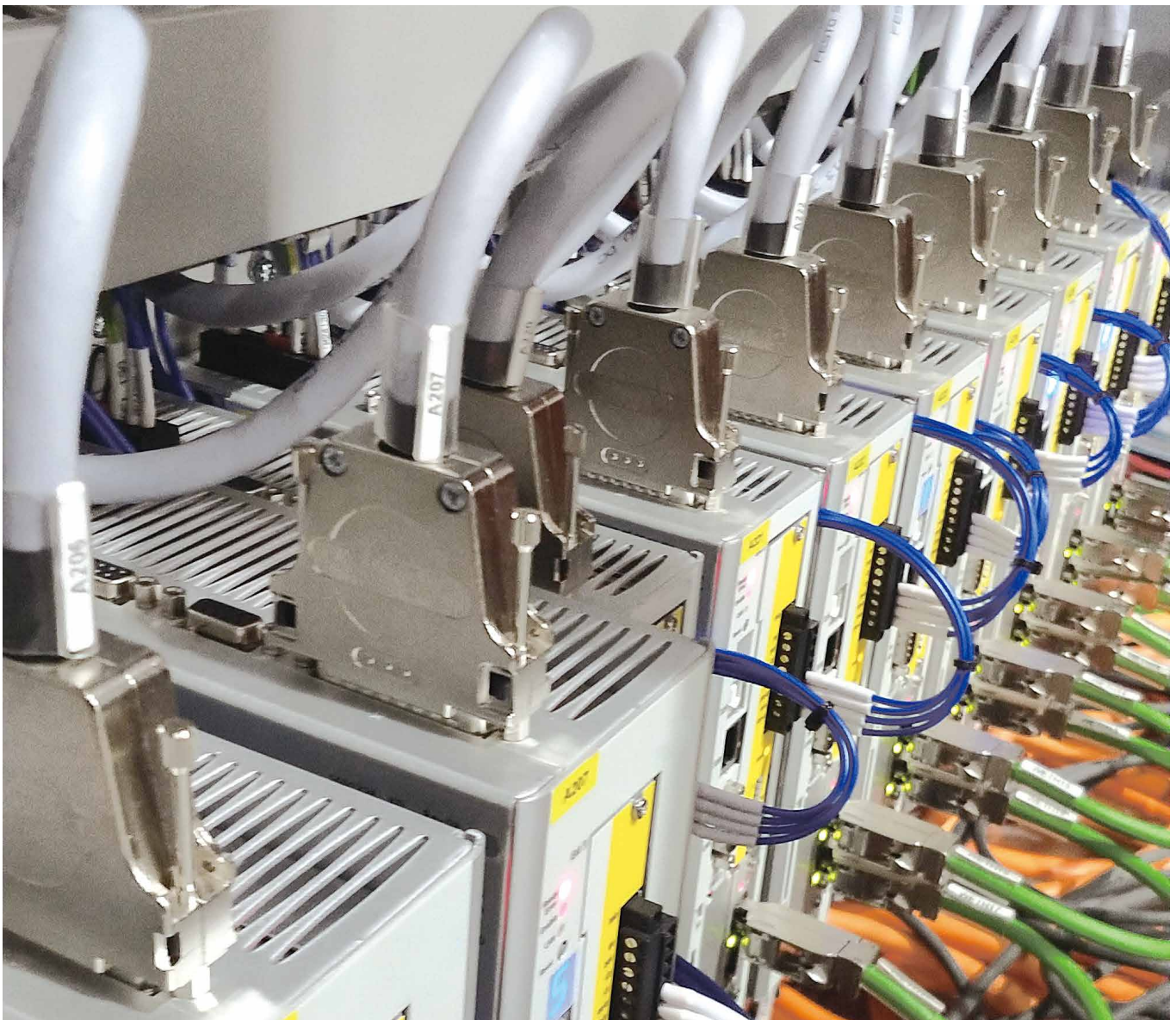

SUBCON 总线连接器

11.2

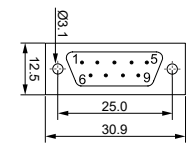
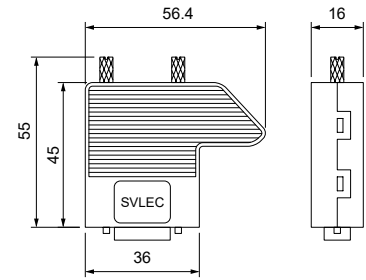
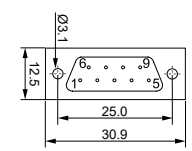

D-SUB 连接器 Connector

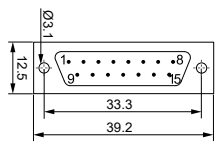
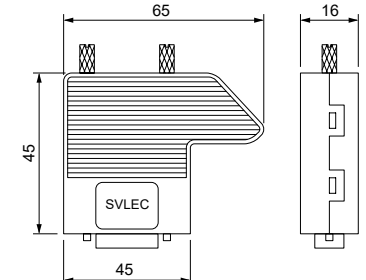
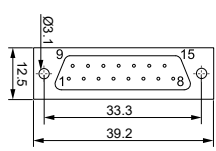

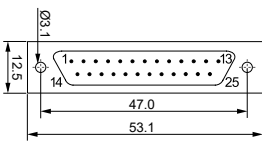
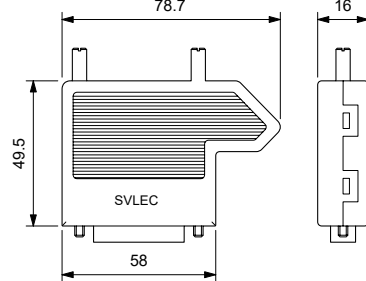
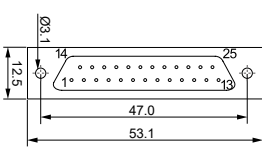
※ 推荐产品

SUBCON 屏蔽外壳, 免焊接头	插芯 Insert	订货号 Part No.	电路图 Circuit diagram	示意图 Description (mm)
9-pole 螺钉压接 	插针 Male	955091		
	插孔 Female	955092		
15-pole 螺钉压接 	插针 Male	955151		
	插孔 Female	955152		
25-pole 螺钉压接 	插针 Male	955251		
	插孔 Female	955252		

额定电压 Supply voltage: 50V AC/DC
 额定电流 Current per contact (40° C): 1A
 温度范围 Temperature range: -20...+75 ° C
 压线方式 Wiring method: 螺钉压接 With screw terminals
 压线范围 Wire diameter: 4...10 mm

工具 Tool		型号 Form	订货号 Part No.
	信号插针压线钳 The signal pin wire clamp	CPT-S	999991
	退针器 Removal tool	REMOV-D-SUB	600002004

D-SUB 连接器

D-SUB 9/15 Pin 连接器

屏蔽 Shielded
压接或焊接
Crimp / solder pins

插针 Male
180°



插孔 Female
180°



壳体规格 Size: Size1

1	型号 Form 焊接式 Solder	900009	900315	901009	901315
	压接式 Crimp	900109		902009	
	极数 Suppression	9-pole	15-pole	9-pole	15-pole

插针 Male
45°



插孔 Female
45°



壳体规格 Size: Size1G

2	型号 Form 焊接式 Solder	910009	910315	911009	911315
	压接式 Crimp	910109		912009	
	极数 Suppression	9-pole	15-pole	9-pole	15-pole

电路图 Circuit diagram	插针 Male 9 Pin	插针 Male 15 Pin	插孔 Female 9 Pin	插孔 Female 15 Pin

压线范围 Wire diameter 6...8.7 mm

2 技术参数 Technical data

额定电压 Supply voltage	30V AC/DC
额定电流 Current per contact (40°C)	2A
温度范围 Temperature range	- 25...+ 85 °C
压线方式 Wiring method	冷压压接 (冷压针见下表) Crimp terminal

针 Crimp contacts

技术参数 Technical data
材质 Material: 铜镀银 / 金
Copper alloy silver/gold-plated
接触电阻 Contact resistance: ≤ 4 mΩ
接线形式 Terminal: 冷压接线 Crimp terminal

冲压针 Stamped Contacts



车针 Machined Contacts

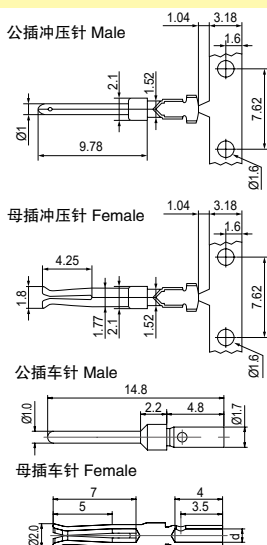

线径 Wire	AWG	冲压针 Stamped Contacts (500 pieces / 卷 reel)		车针 Machined Contacts (100 pieces / 包 pu)	
		型号 Form	订货号 Part No.	型号 Form	订货号 Part No.
0.09-0.25mm ²	26-22	公针 SAM-13	3670007167	公针 DAM-13	3670005576
0.25-0.56mm ²	22-20	公针 SAM-33	3670008167	公针 DAM-33	3670008576
0.09-0.25mm ²	26-22	母针 SAF-13	3670007267	母针 DAF-13	3670005476
0.25-0.56mm ²	22-20	母针 SAF-33	3670008267	母针 DAF-33	3670008476

备注 Notes

D-SUB 15/26 Pin 连接器

屏蔽 Shielded
压接或焊接
Crimp / solder pins

插针 Male
180°



插孔 Female
180°



壳体规格 Size: Size 2

1	型号 Form 焊接式 Solder	900015	900026	901015	901026
	压接式 Crimp	900115		902015	
	极数 Suppression	15-pole	26-pole	15-pole	26-pole
	插针 Male 45°				
	壳体规格 Size: Size 2G				
	型号 Form 焊接式 Solder	910015	910026	911015	911026
	压接式 Crimp	910115		912015	
	极数 Suppression	15-pole	26-pole	15-pole	26-pole
	电路图 Circuit diagram	插针 Male 15 Pin 	插针 Male 26 Pin 	插孔 Female 15 Pin 	插孔 Female 26 Pin
	压线范围 Wire diameter	8...11 mm			

2 技术参数 Technical data

额定电压 Supply voltage: 30V AC/DC
 额定电流 Current per contact (40°C): 2A
 温度范围 Temperature range: -25...+85 °C
 压线方式 Wiring method: 冷压压接 (冷压针见下表) Crimp terminal

针 Crimp contacts

技术参数 Technical data

材质 Material: 铜镀银 / 金

Copper alloy silver/gold-plated

接触电阻 Contact resistance: ≤ 4 mΩ

接线形式 Terminal: 冷压接线 Crimp terminal

冲压针 Stamped Contacts



车针 Machined Contacts

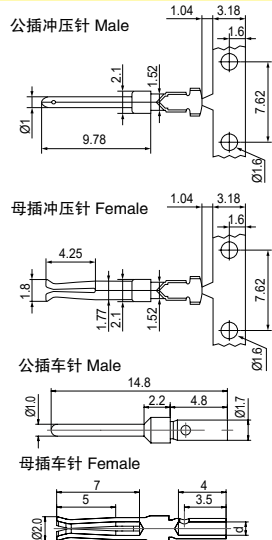

线径 Wire	AWG	冲压针 Stamped Contacts (500 pieces / 卷 reel)		车针 Machined Contacts (100 pieces / 包 pu)	
		型号 Form	订货号 Part No.	型号 Form	订货号 Part No.
0.09-0.25mm ²	26-22	SAM-13	3670007167	DAM-13	3670005576
0.25-0.56mm ²	22-20	SAM-33	3670008167	DAM-33	3670008576
0.09-0.25mm ²	26-22	SAF-13	3670007267	DAF-13	3670005476
0.25-0.56mm ²	22-20	SAF-33	3670008267	DAF-33	3670008476

备注 Notes

D-SUB 连接器

D-SUB 25 Pin 连接器

屏蔽 Shielded
压接或焊接
Crimp / solder pins

插针 Male
180°



插孔 Female
180°



壳体规格 Size: Size 3

1 型号 Form 焊接式 Solder

900025

901025

压接式 Crimp

900125

902025

极数 Suppression

25-pole

25-pole

插针 Male
45°



插孔 Female
45°



壳体规格 Size: Size 3G

型号 Form 焊接式 Solder

910025

911025

压接式 Crimp

910125

912025

极数 Suppression

25-pole

25-pole

电路图 Circuit diagram

插针 Male 25 Pin

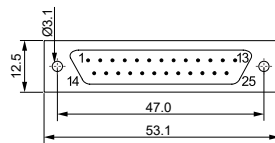

插孔 Female 25 Pin

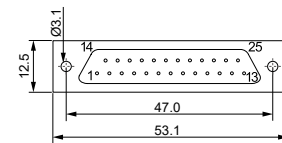

压线范围 Wire diameter

8...11 mm

2 技术参数 Technical data

额定电压 Supply voltage

30V AC/DC

额定电流 Current per contact (40°C)

2A

温度范围 Temperature range

- 25...+ 85 °C

压线方式 Wiring method

冷压压接 (冷压压见下表) Crimp terminal

针 Crimp contacts

技术参数 Technical data

材质 Material: 铜镀银 / 金

Copper alloy silver/gold-plated

接触电阻 Contact resistance: ≤ 4 mΩ

接线形式 Terminal: 冷压接线 Crimp terminal

冲压针 Stamped Contacts



车针 Machined Contacts

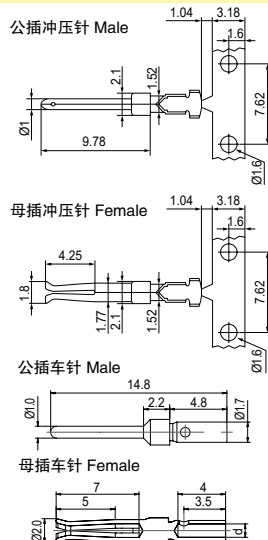

线径 Wire	AWG	冲压针 Stamped Contacts (500 pieces / 卷 reel)		车针 Machined Contacts (100 pieces / 包 pu)	
		型号 Form	订货号 Part No.	型号 Form	订货号 Part No.
0.09-0.25mm ²	26-22	SAM-13	3670007167	DAM-13	3670005576
0.25-0.56mm ²	22-20	SAM-33	3670008167	DAM-33	3670008576
0.09-0.25mm ²	26-22	SAF-13	3670007267	DAF-13	3670005476
0.25-0.56mm ²	22-20	SAF-33	3670008267	DAF-33	3670008476

备注 Notes

D-SUB 连接器外壳

45° 出线

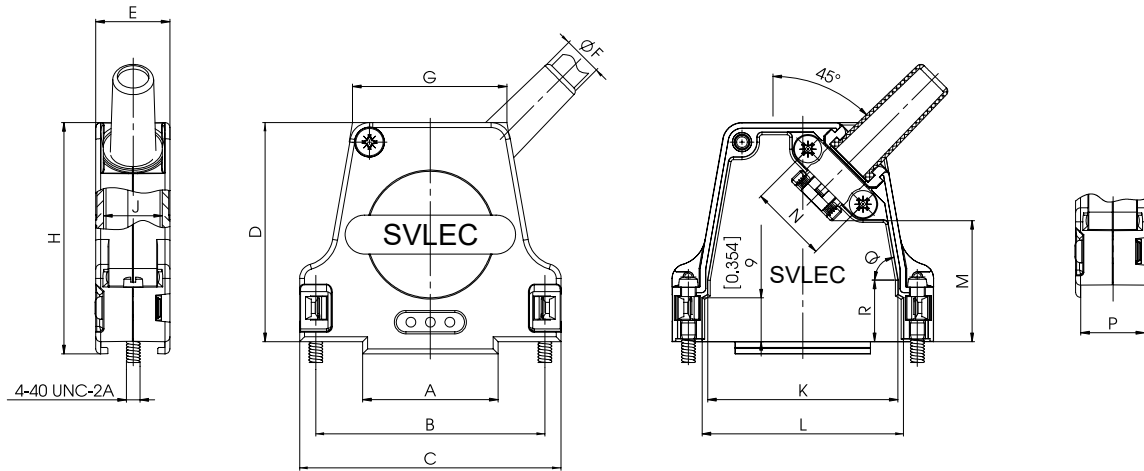

壳体规格 Size	特征 Features	Shell Size/for	A	B	C	D	E	Ø F		G	H	J	K	L	M	N	P	Q	R
								不带橡胶套 Without Rubber Bushing	带橡胶套 With Rubber Bushing max.										
SIZE1		1 / 9	15.3	25.0	32.2	40.0	15.2	3.0 - 9.5	6.5	20.8	42.5	12.1	17.0	19.0	23.0	12.0	12.0		
SIZE2-1		2 / 15	19.2	33.3	40.0	41.5	15.2	3.0 - 8.5	6.5	23.3	43.7	12.1	23.4	27.9	21.0	16.0	12.0	84°	
SIZE2-2		2 / 15	19.2	33.3	40.0	41.5	15.2	8.5 - 12.5	9.0	23.3	43.7	12.1	23.4	27.9	21.0	16.0	12.0	84°	
SIZE3-1	大外径 Large cable outlet	3 / 25	33.5	47.0	54.5	41.5	15.2	3.0 - 8.5	8.0	38.0	43.7	12.1	42.0	42.2	25.0	16.0	12.0	80°	12.9
SIZE3-2	大外径 Large cable outlet	3 / 25	33.5	47.0	54.5	41.5	15.2	8.5 - 12.5	9.0	38.0	43.7	12.1	42.0	42.2	25.0	16.0	12.0	80°	12.9

180° 出线

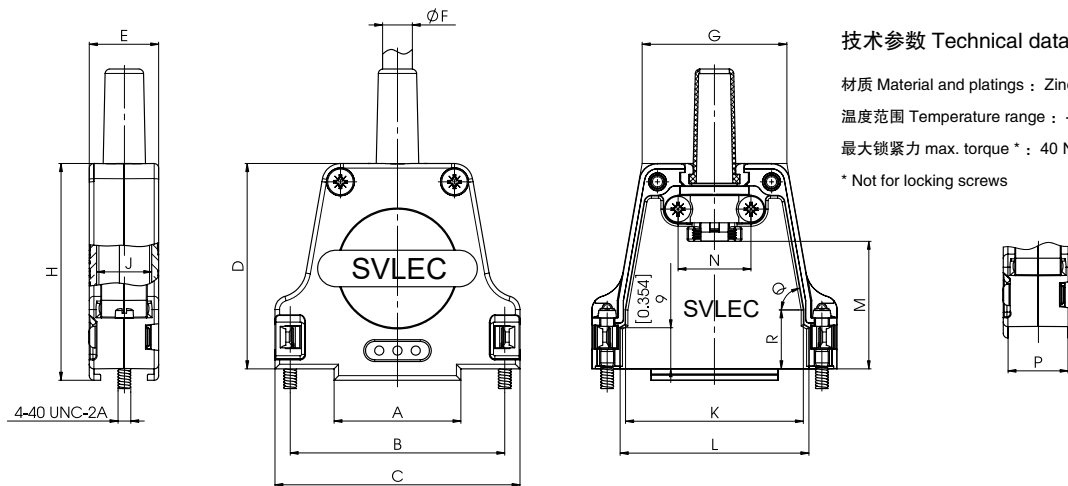

技术参数 Technical data

材质 Material and platings : Zinc die-cast, nickel plated
 温度范围 Temperature range : -25°C bis 85°C (-67°F to 212°F)
 最大锁紧力 max. torque * : 40 Ncm (0.295 ft.lb.)
 * Not for locking screws

壳体规格 Size	特征 Features	Shell Size/for	A	B	C	D	E	Ø F		G	H	J	K	L	M	N	P	Q	R
								不带橡胶套 Without Rubber Bushing	带橡胶套 With Rubber Bushing max.										
SIZE1G		1 / 9	15.3	25.0	32.2	40.0	15.2	3.0 - 9.5	6.5	20.8	42.5	12.1	17.0	19.0	23.5	12.0	12.0		
SIZE2G-1		2 / 15	19.2	33.3	40.0	41.5	15.5	3.0 - 8.5	6.5	23.3	43.7	12.1	23.4	27.9	19.0	16.0	12.0	84°	
SIZE2G-2		2 / 15	19.2	33.3	40.0	41.5	15.2	8.5 - 12.5	9.0	23.3	43.7	12.1	23.4	27.9	19.0	16.0	12.0	84°	
SIZE3G-1	大外径 Large cable outlet	3 / 25	33.5	47.0	54.5	41.5	15.2	3.0 - 8.5	8.0	38.0	43.7	12.1	42.0	42.2	28.0	16.0	12.0	80°	12.9
SIZE3G-2	大外径 Large cable outlet	3 / 25	33.5	47.0	54.5	41.5	15.2	8.5 - 12.5	9.0	38.0	43.7	12.1	42.0	42.2	28.0	16.0	12.0	80°	12.9