

# 第三章 Chapter 3

## 工业照明 LED Light



3.1

条型灯



3.2

塔灯



3.3

指示灯

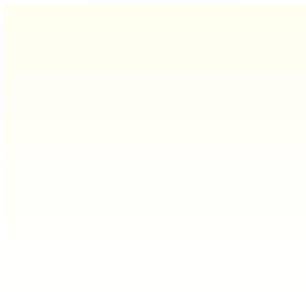

# 工业照明 LED LED Light



工业照明 LED

提高生产率 Increased productivity

提高产品质量 Improve product quality

降低成本 Cost reduction



了解产品详情，敬请关注微信公众号！

或登录 [www.svlec.com](http://www.svlec.com)

# 工业照明 LED LIGHT

## 型号规格说明 Ordering information ( GLZT 工业照明 LED 灯 )

LED 工业照明解决方案，选型美观，品质优良，高效节能，使用寿命长达 50,000 小时，坚固耐用，配以防震外壳，适用于各种工业应用，包括机器照明，封闭区的照明，视觉检测照明，工作间照明等。直流低压供电，可通过 PLC 或者其他控制系统进行控制，从而进一步达到节能的效果。

LED industrial lighting solutions, beautiful selection, excellent quality, high efficiency and energy saving, service life up to 50,000 hours, firm and durable, with shock-proof housing, suitable for various industrial applications, including machine lighting, closed area lighting, visual inspection lighting, workshop lighting, etc. DC low-voltage power supply can be controlled by PLC or other control system, so as to further achieve the effect of energy saving.



GLZT1



GLZT3



工业 LED 照明条形状

GLZT1 = 电柜灯  
GLZT3 = 条型灯

色温 Color temperature

1= 正白色

瓦数 Power

06 = 6 W  
12 = 12W  
18 = 18 W  
24 = 24 W  
30 = 30 W

额定电压 Supply voltage

1 = 12 ~ 24 DC  
3 = 12 ~ 24 AC  
2 = 85 ~ 265 AC 50/60Hz

出线方式 Terminations technology

M12 = M12x4 针公插法兰座  
2M12 = 双端 M12x4 针公插法兰座  
0.5M = 0.5 米 (默认)

## GLZT1 电柜灯 Cabinet lamp

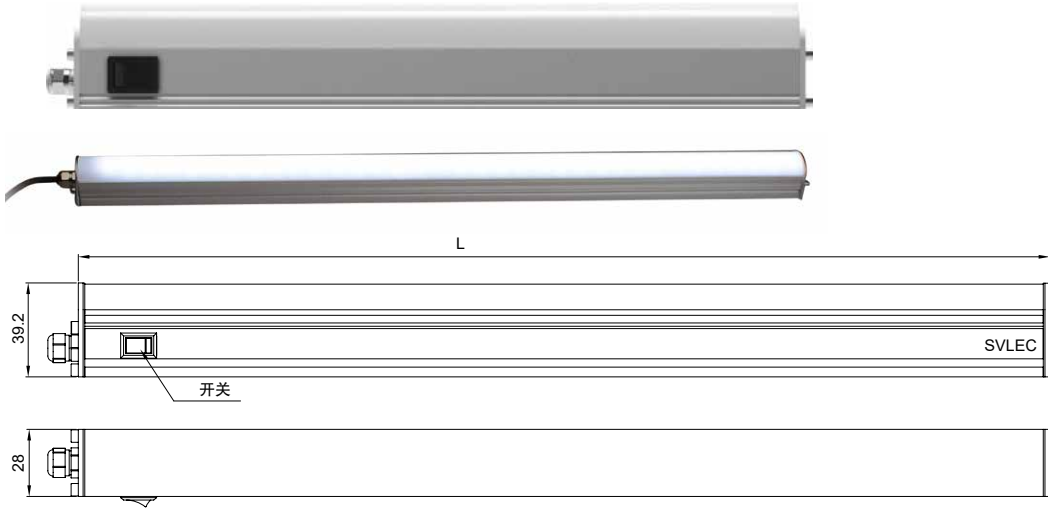

### 1 技术参数 Technical parameters

电子控制器 Electronic Control Gear: 驱动器 Driver  
 保护等级 Class of Protection: III  
 防护等级 Luminaire of Protection: IP20  
 LED 光源: 5630

### 2 特点 Features

- 1、特殊光学结构, 照明无眩光, 发光均匀 Special optics structure, flicker-free, uniform light distribution;
- 2、高效率, 节约能源损耗 Saving energy consumption;
- 3、较传统光源寿命长, 降低维护费用  
 It has a longer lifetime than traditional light sources, which reduces maintenance;
- 4、灵活便捷, 启动快, 允许频繁启动 Quick start and frequent starts allowed;
- 5、绿色环保、无频闪、无紫外线光、无红外辐射  
 Green environmental protection, no stroboscopic, no ultraviolet (uv) light, no infrared radiation.

### 3 应用场所 Application

高铁检查机、冰柜、电柜、冷柜、数控机床及其他照明。  
 Deep freezer, electrical cabinet, armature, CNC machine tools and other lighting.

型号 Type	订货号 Part No.	输入电压 Input Voltage	功率 Power	色温 Color Temperature	光通量 Luminous Dlux	总长 (L) Total Length
GLZT1-106-1-X	711061-X	24V DC	6 W	6000K-6500K 正白	600 lm	600 mm
GLZT1-106-3-X	711063-X	24V AC	6 W	6000K-6500K 正白	600 lm	600 mm
GLZT1-106-2-X	711062-X	85~265V AC 50/60Hz	6 W	6000K-6500K 正白	600 lm	600 mm
GLZT1-109-1-X	711091-X	24V DC	9W	6000K-6500K 正白	900 lm	900 mm
GLZT1-109-3-X	711093-X	24V AC	9W	6000K-6500K 正白	900 lm	900 mm
GLZT1-109-2-X	711092-X	85~265V AC 50/60Hz	9W	6000K-6500K 正白	900 lm	900 mm
GLZT1-112-1-X	711121-X	24V DC	12 W	6000K-6500K 正白	1200 lm	1200 mm
GLZT1-112-3-X	711123-X	24V AC	12 W	6000K-6500K 正白	1200 lm	1200 mm
GLZT1-112-2-X	711122-X	85~265V AC 50/60Hz	12 W	6000K-6500K 正白	1200 lm	1200 mm

备注 X代表出线方式: M12=M12x4 针公插法兰座, 2M12= 双端 M12x4 针公插法兰座, 0.5M=0.5米(默认)。

# 工业照明 LED LIGHT

## GLZT3 条形 LED 灯 Strip LED lamp

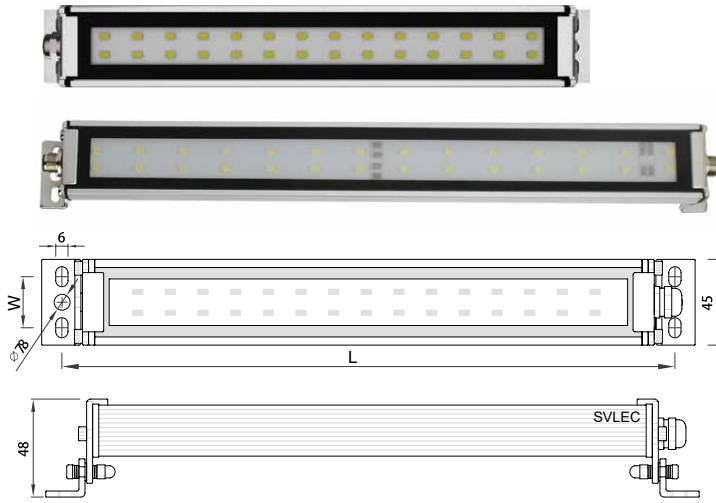

接线方式 DC

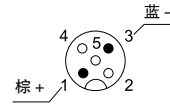

接线方式 AC

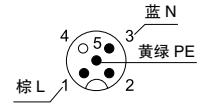

直接出线



M12 接口



支架

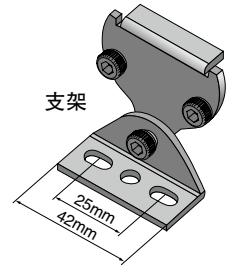

### 1 技术参数 Technical parameters

电子控制器 Electronic Control Gear; 驱动器 Driver  
 保护等级 Class of Protection: I or III  
 防护等级 Luminaire of Protection: IP67  
 管径 Diameter of Tube: Ø45 mm

### 2 特点 Features

- 1、防水、防油、防蚀与防爆功能 Good functions of Water proof, oil proof, anti-corrosion and anti-riot;
- 2、光线分布均匀, 显色性强, 照明效果好 Uniform distribution of light, strong color rendering, good lighting effect;
- 3、安装简易、维修率低 Easy installation and low maintenance;
- 4、优质美国进口芯片 LED 光源、具有低功耗、高效能、寿命长;  
 The LED chips of light source are imported from USA, it has good performance of low power consumption, high efficiency and long life time;
- 5、交 / 直流高品质电子驱动器, 具有低功耗、保护电路功能, 寿命长;  
 The high quality of AC/DC LED driver with the good parameters of low power consumption, protect circuit function and long life time;
- 6、散热性好的优质铝、透明钢化玻璃 High-quality aluminium and transparent toughened glass with good heat dissipation;
- 7、高品质防水接头、金属铝基板、硅橡胶密封圈、反光杯或透镜;  
 The quality of waterproof connector, aluminum PCB, silicone rubber sealing ring and reflector/lens;
- 8、显色指数 Color rendering index >80;
- 9、工作环境温度 Ambient working temperature: -25°C ~ +55°C。

### 3 应用场所 Application

数控机床、组合机床、加工中心、  
 电柜、冷库、矿井及其他照明。

CNC machine tools, machine tool, machining center, cold storage, electrical cabinet, freezer, mine and other lighting.

型号 Type	订货号 Part No.	输入电压 Input Voltage	功率 Power	色温 Color Temperature	安装尺寸 (L × W) Installation Dimension	光通量 Luminous Flux
GLZT3-106-1-X	731061-X	12~24V DC	6 W	6000K~6500K 正白	297 mm × 25 mm	600 lm
GLZT3-106-3-X	731063-X	12~24V AC	6 W	6000K~6500K 正白	297 mm × 25 mm	600 lm
GLZT3-106-2-X	731062-X	85~265V AC 50/60Hz	6 W	6000K~6500K 正白	297 mm × 25 mm	600 lm
GLZT3-112-1-X	731121-X	12~24V DC	12 W	6000K~6500K 正白	418 mm × 25 mm	1200 lm
GLZT3-112-3-X	731123-X	12~24V AC	12 W	6000K~6500K 正白	418 mm × 25 mm	1200 lm
GLZT3-112-2-X	731122-X	85~265V AC 50/60Hz	12 W	6000K~6500K 正白	418 mm × 25 mm	1200 lm
GLZT3-118-1-X	731181-X	12~24V DC	18 W	6000K~6500K 正白	595 mm × 25 mm	1800 lm
GLZT3-118-3-X	731183-X	12~24V AC	18 W	6000K~6500K 正白	595 mm × 25 mm	1800 lm
GLZT3-118-2-X	731182-X	85~265V AC 50/60Hz	18 W	6000K~6500K 正白	595 mm × 25 mm	1800 lm
GLZT3-124-1-X	731241-X	12~24V DC	24 W	6000K~6500K 正白	784 mm × 25 mm	2400 lm
GLZT3-124-3-X	731243-X	12~24V AC	24 W	6000K~6500K 正白	784 mm × 25 mm	2400 lm
GLZT3-124-2-X	731242-X	85~265V AC 50/60Hz	24 W	6000K~6500K 正白	784 mm × 25 mm	2400 lm
GLZT3-130-1-X	731301-X	12~24V DC	30 W	6000K~6500K 正白	1008 mm × 25 mm	3000 lm
GLZT3-130-3-X	731303-X	12~24V AC	30 W	6000K~6500K 正白	1008 mm × 25 mm	3000 lm
GLZT3-130-2-X	731302-X	85~265V AC 50/60Hz	30 W	6000K~6500K 正白	1008 mm × 25 mm	3000 lm

备注 X 代表出线方式: M12=M12x4 针公插法兰座, 2M12= 双端 M12x4 针公插法兰座, 0.5M=0.5 米 (默认)。

Note: X means line output M12=M12x4 pin male Flange Installation; 2M12=Double side M12x4 pin male Flange Installation. Standard cable length=0.5M

两个条形灯连接线缆 M12 母直转 M12 母直插头, 型号为 940023-214-xxxx

## 型号规格说明 Ordering information ( GLTD 信号灯 )

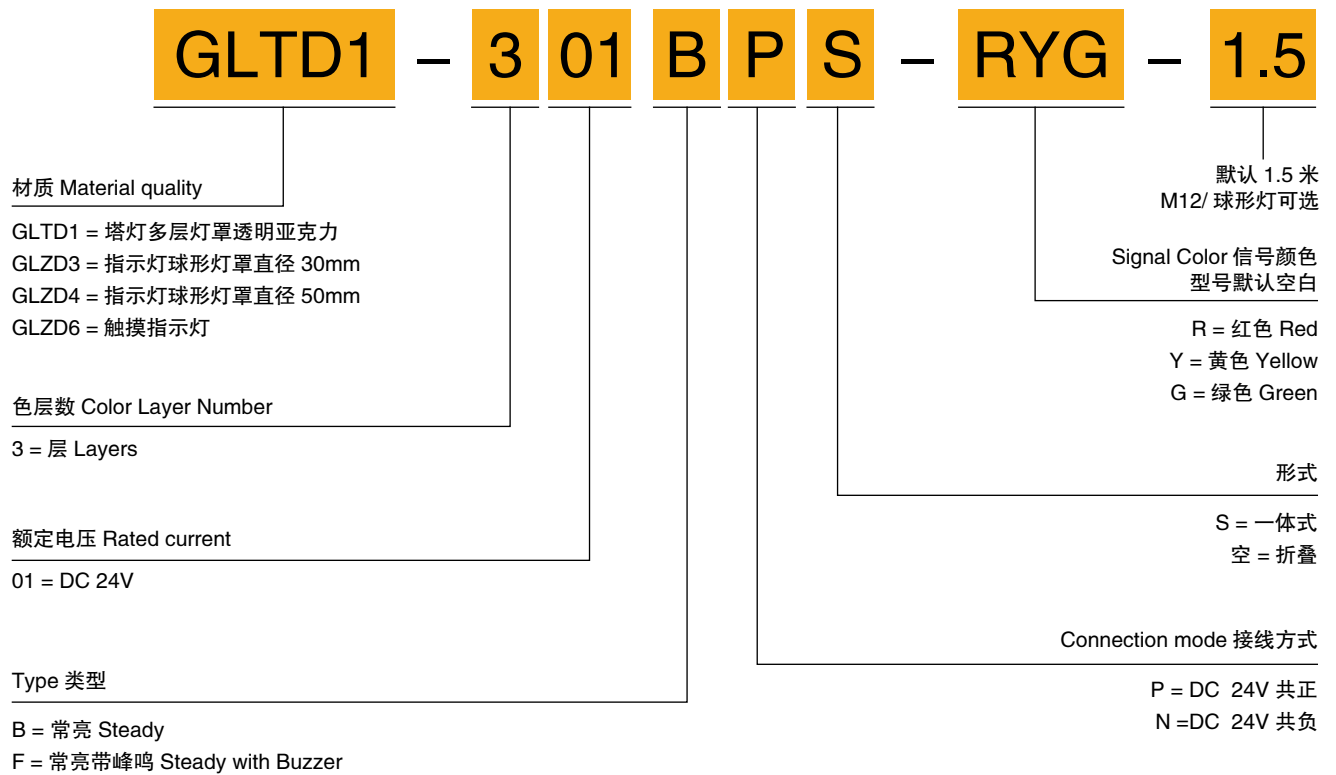

### GLTD1 塔灯

信号塔等系列基于 LED 光源设计, 使用寿命长, 无需维护。型号丰富造型独特, 坚固耐用, 皆由工厂组装, 并有多多种安装附件选择。型号繁多, 能够为客户提供定制的解决方案, 包括交流, 直流电源选择, 三种报警输出选项, 标准或者高亮度选择, 及快速接插件或电缆式选择。

Signal Tower series based on LED light source design, long service life, no maintenance. The model is rich, unique, firm and durable. It is assembled by the factory and has a variety of installation accessories. Various models can provide customers with customized solutions, including AC, DC power selection, three alarm output options, standard or high brightness selection, and fast connector or cable selection.

### GLTD3/4 指示灯

指示灯亮度高, 种类繁多, 即使白天也能清晰可见。SVLEC 指示灯产品坚固耐用, 使用寿命长, 无须加装防护盒。尺寸大小和安装方式多样, 为各种状态指示应用提供独家解决方案。

Indicators are of high brightness and various types, and can be clearly visible even in the daytime. SVLEC indicator products are durable, long service life, no need to install protective boxes. Dimensions, sizes and installation methods are diverse, providing exclusive solutions for various status indication applications.

# 工业照明 LED LIGHT

## GLTD1 折叠型塔灯 LED Multi-Functional Signal Light

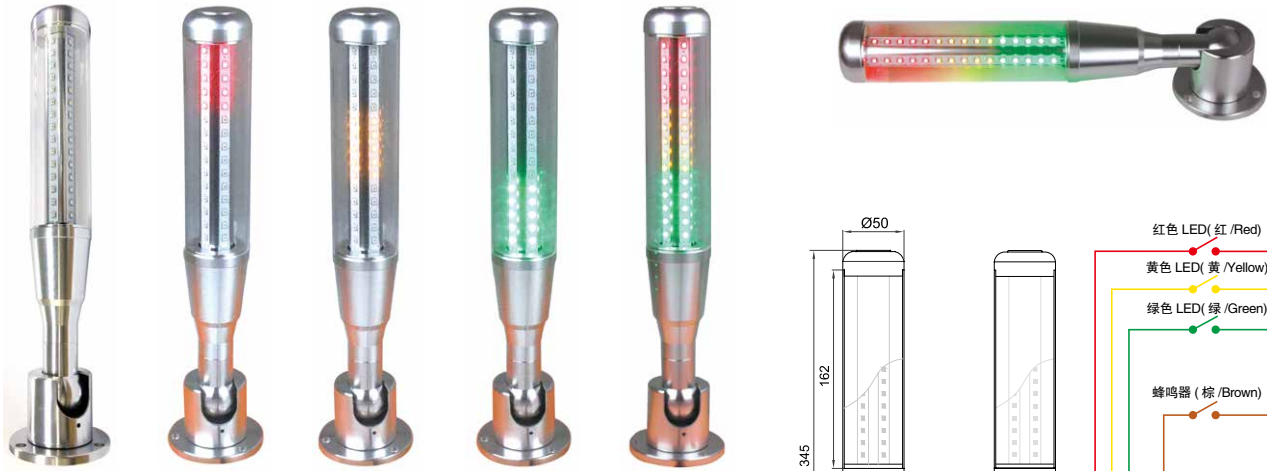

### 1 技术参数 Technical parameters

电子控制器 Electronic Control Gear: RGY (BW)  
 寿命 Life time: 50000h  
 防护等级 Luminaire of Protection: IP65  
 Beam angle 光束角: 360°

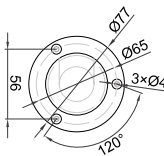

底座安装孔

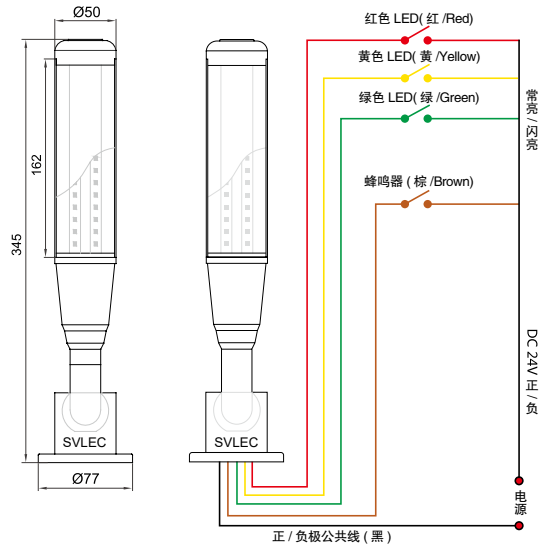

### 2 特点 Features

- 1、高效 LED 多功能信号灯, 可满足各种需求, 性价比高 Efficient LED multi signal lamps meets the various needs with good price;
- 2、高亮 LED 光源, 大大提高了远距离的可视性能 High bright LED improving the visual performance of long distance;
- 3、利用红黄绿 LED 光源产生鲜明的色彩识别效果 With red/yellow/green color led improving the color recognition effect;
- 4、灵安装简便, 方便拆卸 Easy installation and dismounting;
- 5、灯体由高品质铝制成, 耐热抗冲击, 外观时尚, 可折叠;  
 The lamp body is made of high quality aluminum, with good thermal and shock resistance, it looks more modern and it is collapsible;
- 6、灯罩由耐热抗冲击透明的亚克力制成。  
 The lampshade is made of transparent Acrylic, with good function of thermal and shock resistance.

### 3 应用场所 Application

数控机床、组合机床、加工中心、安防设备、激光设备、流水线、安检系统及其他照明。  
 CNC machine tools, machine tool, machining center, security equipment, laser equipment, assembly line, security system and other lighting.

型号 Type	订货号 Part No.	额定电压 Input Voltage	类型 Type	接线方式 Termination methods	信号颜色 Signal Color	灯外径 Designation	蜂鸣器 Buzzer
GLTD1-301-BP	813011	DC 24V	常亮	DC 24V 共正	红色、黄色、绿色	50 mm	否
GLTD1-301-BN	813012	DC 24V	常亮	DC 24V 共负	红色、黄色、绿色	50 mm	否
GLTD1-301-FP	813013	DC 24V	常亮	DC 24V 共正	红色、黄色、绿色	50 mm	是
GLTD1-301-FN	813014	DC 24V	常亮	DC 24V 共负	红色、黄色、绿色	50 mm	是

- 1、以上产品安装形式为可折叠
- 2、默认 3 层, 如有需要 4、5 层请咨询

## GLTD1 一体式塔灯 LED Multi-Functional Signal Light

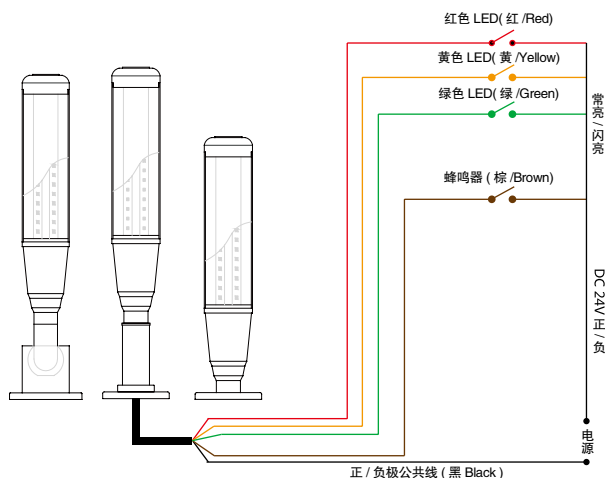
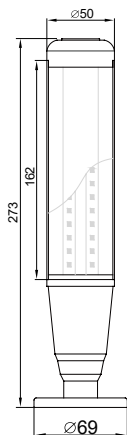

### 1 技术参数 Technical parameters

电子控制器 Electronic Control Gear: RGY (BW)  
 寿命 Life time: 50000h  
 防护等级 Luminaire of Protection: IP65  
 Beam angle 光束角: 360°

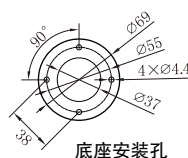

### 2 特点 Features

- 1、高效 LED 多功能信号灯, 可满足各种需求, 性价比高 Efficient LED multi signal lamps meets the various needs with good price;
- 2、高亮 LED 光源, 大大提高了远距离的可视性能 High bright LED improving the visual performance of long distance;
- 3、利用红黄绿 LED 光源产生鲜明的色彩识别效果 With red/yellow/green color led improving the color recognition effect;
- 4、灵安装简便, 方便拆卸 Easy installation and dismounting;
- 5、灯体由高品质铝制成, 耐热抗冲击, 外观时尚, 可折叠;  
The lamp body is made of high quality aluminum, with good thermal and shock resistance, it looks more modern and it is collapsible;
- 6、灯罩由耐热抗冲击透明的亚克力制成。  
The lampshade is made of transparent Acrylic, with good function of thermal and shock resistance.

### 3 应用场所 Application

数控机床、组合机床、加工中心、安防设备、激光设备、流水线、安检系统及其他照明。

CNC machine tools, machine tool, machining center, security equipment, laser equipment, assembly line, security system and other lighting.

型号 Type	订货号 Part No.	额定电压 Input Voltage	类型 Type	接线方式 Termination methods	信号颜色 Signal Color	灯外径 Designation	蜂鸣器 Buzzer
GLTD1-301-BPS	8130111	DC 24V	常亮	DC 24V 共正	红色、黄色、绿色	50 mm	否
GLTD1-301-BNS	8130121	DC 24V	常亮	DC 24V 共负	红色、黄色、绿色	50 mm	否
GLTD1-301-FPS	8130131	DC 24V	常亮	DC 24V 共正	红色、黄色、绿色	50 mm	是
GLTD1-301-FNS	8130141	DC 24V	常亮	DC 24V 共负	红色、黄色、绿色	50 mm	是

默认 3 层, 如有需要 4、5 层请咨询



# 工业照明 LED LIGHT

## GLZD 指示灯 Multi-Functional Signal Light

### O30 警示灯

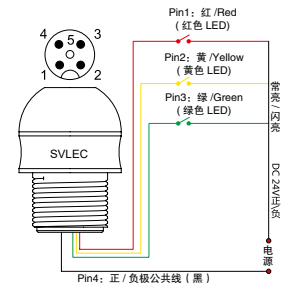
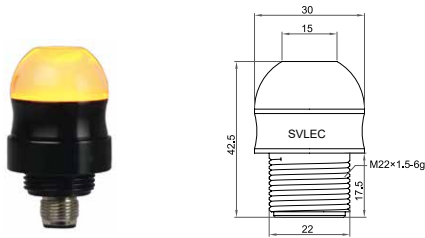

型号 Type	订货号 Part No.	额定电压 Input Voltage	类型 Type	接线方式 Termination methods	信号颜色 Signal Color	螺纹直径 Designation	蜂鸣器 Buzzer
GLZD3-301-BP-X	833011	DC 24V	常亮	DC 24V 共正	红色、黄色、绿色	22 mm	否
GLZD3-301-BN-X	833012	DC 24V	常亮	DC 24V 共负	红色、黄色、绿色	22 mm	否
GLZD3-301-FP-X	833013	DC 24V	常亮	DC 24V 共正	红色、黄色、绿色	22 mm	是
GLZD3-301-FN-X	833014	DC 24V	常亮	DC 24V 共负	红色、黄色、绿色	22 mm	是

备注 X 代表出线方式: M12=M12x4 针公插法兰座, 1.5M=1.5 米 (默认)。

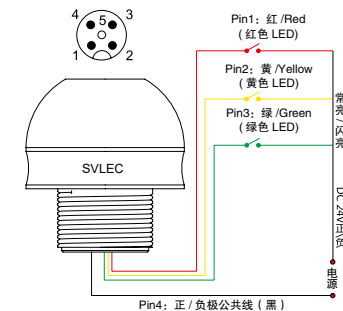

型号 Type	订货号 Part No.	额定电压 Input Voltage	类型 Type	接线方式 Termination methods	信号颜色 Signal Color	螺纹直径 Designation	蜂鸣器 Buzzer
GLZD4-301-BP-X	843011	DC 24V	常亮	DC 24V 共正	红色、黄色、绿色	30 mm	否
GLZD4-301-BN-X	843012	DC 24V	常亮	DC 24V 共负	红色、黄色、绿色	30 mm	否
GLZD4-301-FP-X	843013	DC 24V	常亮	DC 24V 共正	红色、黄色、绿色	30 mm	是
GLZD4-301-FN-X	843014	DC 24V	常亮	DC 24V 共负	红色、黄色、绿色	30 mm	是
GLZD4-501-IO-X	843015	DC 24V	常亮	IO-LINK 协议	红色、黄色、绿色	30 mm	否

备注: X 代表出线方式: M12=M12x4 针公插法兰座, 1.5M=1.5 米 (默认)。

### 1 技术参数 Technical parameters

电子控制器 Electronic Control Gear: RGY (BW)  
 寿命 Life Time: 5000 h  
 防护等级 Luminaire of Protection: IP67  
 光束角 Beam Angle: 360°

### 3 应用场所 Application

数控机床、组合机床、加工中心、安防设备、激光设备、流水线、安检系统及其他照明。

CNC machine tools, machine tool, machining center, security equipment, laser equipment, assembly line, security system and other lighting.

### 2 特点 Features

- 1、高效 LED 多功能信号灯, 可满足各种需求, 性价比高;
- 2、360 度无转角照射, 消除了可能存在的视觉盲点, 大大提高了远距离的可视性能;
- 3、30mm 半球形造型, 内含超长寿命 LED 灯;
- 4、单个信号灯配色可达 3 种, 3 种颜色 (红 / 黄 / 绿) 可选;
- 5、安装简易, 便于维护;
- 6、可选 4 针型接插件 /PVC 电缆。

- 1、Efficient LED multi signal lamps meets the various needs with good price;
- 2、360 degrees without corner exposure, eliminate the visual blind spots may exist, greatly improving the visual performance of long distance;
- 3、30mm hemispherical shape with super long life LED light;
- 4、A single light color can be up to three, three kinds of color ( Red / Yellow / Green ) is optional;
- 5、Easy to install, easy to maintain;
- 6、Optional 4-pin connector/PVC cable.

## GLZD6 触摸指示灯 Touch signal Light

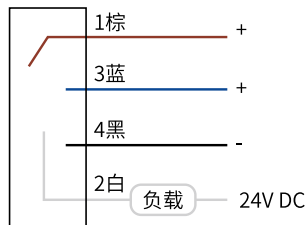
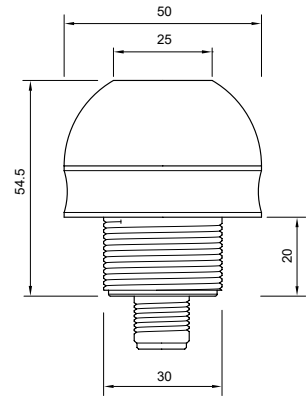

接线	触摸前	触摸后
pin 1棕(+) + pin 4黑(-)	无	● 红LED
pin 1棕(+) + pin 3蓝(+) + pin 4黑(-)	● 绿LED	● 黄LED

型号 Type	订货号 Part No.	额定电压 Input Voltage	类型 Type	接线方式 Termination methods	信号颜色 Signal Color	螺纹直径 Designation	触摸
GLZD6-301-BP-X	853011	DC 24V	常亮	DC 24V 共正	红色、黄色、绿色	22 mm	是
GLZD6-301-BN-X	853012	DC 24V	常亮	DC 24V 共负	红色、黄色、绿色	22 mm	是

备注 X 代表出线方式: M12=M12x4 针公插法兰座, 1.5M=1.5米(默认)。

### 1 特点 Features

- 触摸操作, 便于提高生产效率  
Touch operation, easy to improve production efficiency
- 优质 LED 光源, 使用寿命长, 节能环保  
High-quality LED light source, long service life, energy saving and environmental
- 易于安装, 坚固耐用, 全密封, 防护等级 IP69K  
Easy to install, durable, fully sealed, protection class IP69K