

# 第七章 Chapter 7

## 现场总线线束及连接器 Field bus

	7.1	M12 ( S、T、L、K-Code ) 电源连接器
	7.2	7/8" 电源连接器
	7.3	Profibus
	7.4	Device Net, CANopen
	7.5	Profinet、Ethernet IP、Ether CAT、CAT5e、CAT6 <sub>A</sub>
	7.6	CC-Link
	7.7	AS-i Passive Distributor

# M12 圆形连接器 ROUND PLUG CONNECTOR

M12 S-code  
M12 T-code  
现场接线 Field-wireable

T-code  
插针 Male  
直出 Straight

T-code  
插孔 Female  
直出 Straight



<b>1</b>	<b>型号 Form</b>	<b>No.</b>	<b>912744</b>	<b>912932</b>
	<b>极数</b> Suppression		<b>T-Code</b> 4-pole	<b>T-Code</b> 4-pole

S-code  
插针 Male  
直出 Straight

S-code  
插孔 Female  
直出 Straight



<b>1</b>	<b>型号 Form</b>	<b>No.</b>	<b>912742</b>	<b>912942</b>
	<b>极数</b> Suppression		<b>S-Code</b> 4-pole	<b>S-Code</b> 4-pole

**电路图**  
Circuit diagram

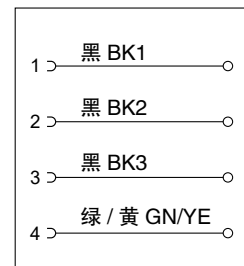
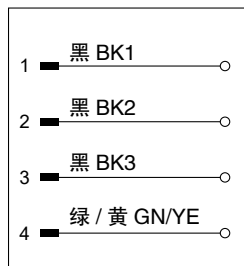

<b>2</b>	<b>技术参数 Technical data</b>
额定电压 Supply voltage	60 V AC/DC ( T-code ) / 630 V AC/DC ( S-code )
额定电流 Current per contact (40°C)	max. 12 A
压线范围 Connection diameter	最大 max. 1.5 mm <sup>2</sup>
外壳材料 Housing material	铜锌合金, 表面镀镍 CuZn, nickel plated
压线方式 Wiring method	螺钉压接 Screw terminal
防护等级 Protection	IP65 – 插孔插针配合 ( ) 拧紧 ( EN 60529 ) When pluggde and screwed down
温度范围 Temperature range	-25...+85°C

**尺寸图 Description**

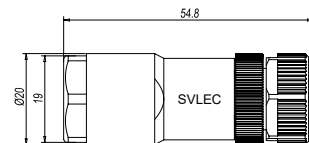
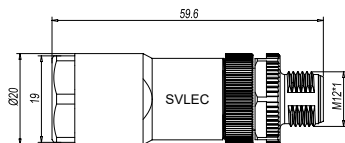

# M12 圆形连接器 ROUND PLUG CONNECTOR

M12 L-code  
M12 K-code  
现场接线 Field-wireable

L-code  
插针 Male  
直出 Straight

L-code  
插孔 Female  
直出 Straight



1	型号 Form	No.	912743	912952
	极数 Suppression		<b>L-Code</b> 5-pole	<b>L-Code</b> 5-pole
1	型号 Form	No.	912745	912962
	极数 Suppression		<b>K-Code</b> 5-pole	<b>K-Code</b> 5-pole
1	电路图 Circuit diagram			
	2	技术参数 Technical data	<p>额定电压 Supply voltage 63 V AC/DC ( L-code ) / 630 V AC/DC ( K-code )</p> <p>额定电流 Current per contact (40°C) max. 12 A</p> <p>压线范围 Connection diameter 最大 max. 1.5 mm<sup>2</sup></p> <p>外壳材料 Housing material 铜锌合金, 表面镀镍 CuZn, nickel plated</p> <p>压线方式 Wiring method 螺钉压接 Screw terminal</p> <p>防护等级 Protection IP65 – 插孔插针配合 ( ) 拧紧 ( EN 60529 ) When pluggde and screwed down</p> <p>温度范围 Temperature range -25...+85°C</p>	
2	尺寸图 Description			

# M12 圆形连接器 ROUND PLUG CONNECTOR

M12 S-code

单端预铸线束

电源 Power

插针 Male  
直出 Straight



插孔 Female  
直出 Straight



插针 Male  
直出 Straight



插孔 Female  
直出 Straight

M12 S-Code

<b>1</b>	<b>型号 Form</b>	<b>No.</b>	<b>912034</b>	<b>912334</b>	<b>942034</b>
	<b>极数</b> Suppression		4-pole	4-pole	4-pole
	<b>电路图</b> Circuit diagram		<p>1 — 棕 BN — 24V (US) 2 — 黑 BK — GND (UA) 3 — 蓝 BU — GND (US) 4 — 绿 / 黄 GN/YE — 24V (UA)</p>	<p>1 — 棕 BN — 24V (US) 2 — 黑 BK — GND (UA) 3 — 蓝 BU — GND (US) 4 — 绿 / 黄 GN/YE — 24V (UA)</p>	<p>1 — 24V (US) 棕 BN — C 1 2 — GND (UA) 黑 BK — C 2 3 — GND (US) 蓝 BU — C 3 4 — 24V (UA) 绿 / 黄 GN/YE — C 4</p>
	<b>针脚排序</b> Contact layout		<p>插针 Male</p>	<p>插孔 Female</p>	<p>插针 Male      插孔 Female</p>
<b>2</b>	<b>电缆类型 Cable type</b>	<b>护套颜色 Jacket color</b>			
	导体横截面 4 x1.5mm <sup>2</sup>	黄 YE			
	PUR	960			
	<b>技术参数 Technical data</b>				
	额定电压 Supply voltage	630 V AC			
	额定电流 Current per contact (40°C)	12A			
	防护等级 Protection	IP67—插孔插针配合拧紧(EN 60529) When plugged and screwed down			
	温度范围 Temperature range	-25...+85°C			
<b>3</b>	<b>电缆长度 Cable length</b>				
	1.5m	0150			
	3.0m	0300			
	5.0m	0500			
	7.5m	0750			
	10.0m	1000			
	<b>订货号 Part No.</b>				
	可参考: 6.0.1 Reference: 6.0.1	<p>例:      <u>  912034  </u>      —      <u>  960  </u>      —      <u>  0500  </u></p>			
		<b>1</b>	<b>型号 Form</b>	<b>2</b>	<b>电缆类型 Cable type</b>
		<b>3</b>	<b>电缆长度 Cable length</b>		
	<b>备注 Notes</b>				
		<p>电缆参数 Cable parameter: 8.3.2    尺寸参数 Size parameter: 6.0.4    配件页面 Accessories on page: 7.7.5 不同的电缆长度可根据实际需要, 在订货号的第三部分自行修改, 电缆长度单位: cm</p>			

# M12 圆形连接器 ROUND PLUG CONNECTOR

M12 T-code  
单端预铸线束  
电源 Power  
额定电压: 60 V AC  
额定电流 (40°C): 12A  
防护等级: IP67  
温度范围: -25...+85 °C

插针 Male  
直出 Straight









插孔 Female  
直出 Straight



插针 Male 直出 Straight  
插孔 Female 直出 Straight

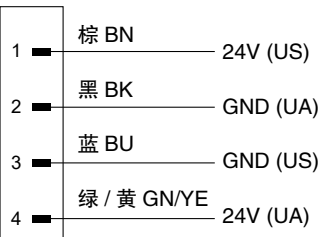
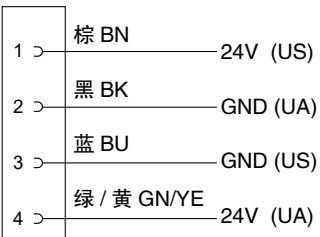

M12 T-Code

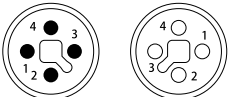
1	型号 Form No.	912044	912344	942044
	极数 Suppression	4-pole	4-pole	4-pole
		插针 Male 直出 Straight 	插孔 Female 直出 Straight 	插针 Male 直出 Straight 插孔 Female 直出 Straight 
	型号 Form No.	912045	912345	942073
	极数 Suppression	4-pole	4-pole	4-pole
	电路图 Circuit diagram			
	针脚排序 Contact layout	插针 Male 	插孔 Female 	插针 Male 插孔 Female 
2	电缆类型 Cable type	护套颜色 Jacket color		
	导体横截面 4 x 1.5mm <sup>2</sup> PUR	黄 YE 960		
3	电缆长度 Cable length			
	1.5m	0150		
	3.0m	0300		
	5.0m	0500		
	7.5m	0750		
	10.0m	1000		
	订货号 Part No.			
	可参考: 6.0.1 Reference: 6.0.1	例: <u>    912044    </u> — <u>    960    </u> — <u>    0500    </u>		
		1 型号 Form	2 电缆类型 Cable type	3 电缆长度 Cable length
	备注 Notes	电缆参数 Cable parameter: 8.3.2 尺寸参数 Size parameter: 6.0.4 配件页面 Accessories on page: 7.7.5 不同的电缆长度可根据实际需要, 在订货号的第三部分自行修改, 电缆长度单位: cm		

# M12 圆形连接器 ROUND PLUG CONNECTOR

M12 L-code

单端预铸线束

电源 Power

额定电压: 60 V AC  
 额定电流 (40°C): 12A  
 防护等级: IP67  
 温度范围: -25...+85

插针 Male  
 直出 Straight



插孔 Female  
 直出 Straight



插针 Male  
 直出 Straight      插孔 Female  
 直出 Straight



1	型号 Form No.	912554	912454	942045
	极数 Suppression	5-pole	5-pole	5-pole
		插针 Male 直出 Straight	插孔 Female 直出 Straight	插针 Male 直出 Straight      插孔 Female 直出 Straight
	型号 Form No.	912555	912455	942046
	极数 Suppression	5-pole	5-pole	5-pole
	电路图 Circuit diagram	<ul style="list-style-type: none"> <li>1 ■ 棕 BN 24V (US)</li> <li>2 ■ 白 WH GND-UA</li> <li>3 ■ 蓝 BU GND-US</li> <li>4 ■ 黑 BK 24V (UA)</li> <li>5 ■ 绿黄 GN/YE FE(PE)</li> </ul>	<ul style="list-style-type: none"> <li>1 ∩ 棕 BN 24V (US)</li> <li>2 ∩ 白 WH GND-UA</li> <li>3 ∩ 蓝 BU GND-US</li> <li>4 ∩ 黑 BK 24V (UA)</li> <li>5 ∩ 绿黄 GN/YE FE(PE)</li> </ul>	<ul style="list-style-type: none"> <li>1 ■ 棕 BN 24V (US)      ∩ C 1</li> <li>2 ■ 白 WH GND-UA      ∩ C 2</li> <li>3 ■ 蓝 BU GND-US      ∩ C 3</li> <li>4 ■ 黑 BK 24V (UA)      ∩ C 4</li> <li>5 ■ 绿黄 GN/YE FE(PE)      ∩ C 5</li> </ul>
	针脚排序 Contact layout	插针 Male 	插孔 Female 	插针 Male      插孔 Female 
2	电缆类型 Cable type	护套颜色 Jacket color		
	导体横截面 4 x1.5mm <sup>2</sup>	黄 YE	黑 BK	
	PVC	961		
	PUR		962	
3	电缆长度 Cable length			
	1.5m	0150		
	3.0m	0300		
	5.0m	0500		
	7.5m	0750		
	10.0m	1000		
订货号 Part No.				
可参考: 6.0.1 Reference: 6.0.1	例: <u>  912554  </u> <u>  961  </u> <u>  0500  </u>			
	1 型号 Form	2 电缆类型 Cable type	3 电缆长度 Cable length	
备注 Notes				

电缆参数 Cable parameter: 8.3.2    尺寸参数 Size parameter: 6.0.4    配件页面 Accessories on page: 7.7.5  
 不同的电缆长度可根据实际需要, 在订货号的第三部分自行修改, 电缆长度单位: cm

# M12 圆形连接器 ROUND PLUG CONNECTOR



L-code 转 T-code

 M12 插针 Male  
L-code

 M12 插孔 Female  
T-code

 M12 插孔 Female  
L-code

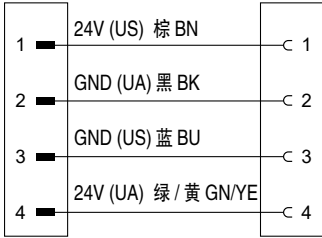
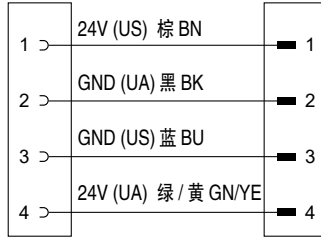
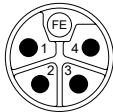
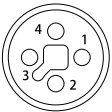
 M12 插针 Male  
T-code



<b>1</b>	<b>型号 Form</b>	<b>No.</b>	<b>942077</b>	<b>942078</b>
	<b>极数</b> Suppression		4-pole	4-pole
	<b>电路图</b> Circuit diagram			
	<b>针脚排序</b> Contact layout		插针 Male 	插孔 Female 
			插孔 Female 	插针 Male 
<b>2</b>	<b>电缆类型 Cable type</b>	<b>护套颜色 Jacket color</b>		
	导体横截面 4 x1.5mm <sup>2</sup>	黄 YE		
	PUR	960		
	<b>技术参数 Technical data</b>			
	额定电压 Supply voltage	60 V DC		
	额定电流 Current per contact (40°C)	12 A		
	防护等级 Protection	IP67-插孔插针配合拧紧(EN 60529) When plugged and screwed down		
	温度范围 Temperature range	-25...+85°C		
<b>3</b>	<b>电缆长度 Cable length</b>			
	1.5m	0150		
	3.0m	0300		
	5.0m	0500		
	7.5m	0750		
	10.0m	1000		
	<b>订货号 Part No.</b>			
	可参考: 6.0.1 Reference: 6.0.1	例: <u>    942071    </u> — <u>    960    </u> — <u>    0500    </u>		
		<b>1</b>	<b>型号 Form</b>	<b>2</b>
		<b>2</b>	<b>电缆类型 Cable type</b>	<b>3</b>
		<b>3</b>	<b>电缆长度 Cable length</b>	
	<b>备注 Notes</b>			
		电缆参数 Cable parameter: 8.3.2 尺寸参数 Size parameter: 6.0.4 配件页面 Accessories on page: 7.7.5 不同的电缆长度可根据实际需要, 在订货号的第三部分自行修改, 电缆长度单位: cm		

# M12 圆形连接器 ROUND PLUG CONNECTOR

M12 S-code

单端预铸线束  
屏蔽 Shield  
电源 Power

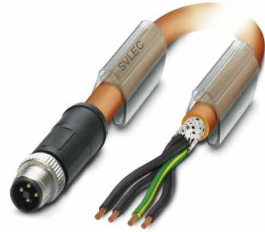
插针 Male  
直出 Straight



插孔 Female  
直出 Straight



插针 Male  
直出 Straight      插孔 Female  
直出 Straight



M12 S-Code

1 型号 Form No.		913034	913334	943034										
极数 Suppression		4-pole	4-pole	4-pole										
电路图 Circuit diagram														
针脚排序 Contact layout		<p>插针 Male</p>	<p>插孔 Female</p>	<p>插针 Male      插孔 Female</p>										
2 电缆类型 Cable type	护套颜色 Jacket color	<table border="1"> <tr> <td>导体横截面 4 x1.5mm<sup>2</sup></td> <td>橙 OG</td> </tr> <tr> <td>PVC</td> <td>902</td> </tr> <tr> <td>PUR</td> <td>901</td> </tr> </table>			导体横截面 4 x1.5mm <sup>2</sup>	橙 OG	PVC	902	PUR	901				
导体横截面 4 x1.5mm <sup>2</sup>	橙 OG													
PVC	902													
PUR	901													
技术参数 Technical data	<table border="1"> <tr> <td>额定电压 Supply voltage</td> <td>630 V AC</td> </tr> <tr> <td>额定电流 Current per contact (40°C)</td> <td>12A</td> </tr> <tr> <td>防护等级 Protection</td> <td>IP67-插孔插针配合拧紧(EN 60529) When plugged and screwed down</td> </tr> <tr> <td>温度范围 Temperature range</td> <td>-25...+85°C</td> </tr> </table>				额定电压 Supply voltage	630 V AC	额定电流 Current per contact (40°C)	12A	防护等级 Protection	IP67-插孔插针配合拧紧(EN 60529) When plugged and screwed down	温度范围 Temperature range	-25...+85°C		
额定电压 Supply voltage	630 V AC													
额定电流 Current per contact (40°C)	12A													
防护等级 Protection	IP67-插孔插针配合拧紧(EN 60529) When plugged and screwed down													
温度范围 Temperature range	-25...+85°C													
3 电缆长度 Cable length	<table border="1"> <tr> <td>1.5m</td> <td>0150</td> </tr> <tr> <td>3.0m</td> <td>0300</td> </tr> <tr> <td>5.0m</td> <td>0500</td> </tr> <tr> <td>7.5m</td> <td>0750</td> </tr> <tr> <td>10.0m</td> <td>1000</td> </tr> </table>				1.5m	0150	3.0m	0300	5.0m	0500	7.5m	0750	10.0m	1000
1.5m	0150													
3.0m	0300													
5.0m	0500													
7.5m	0750													
10.0m	1000													
订货号 Part No.	<p>例:      <u>  913034  </u>      <u>  902  </u>      <u>  0500  </u></p>													
可参考: 6.0.1 Reference: 6.0.1	1 型号 Form	2 电缆类型 Cable type	3 电缆长度 Cable length											
备注 Notes	电缆参数 Cable parameter: 8.3.2    尺寸参数 Size parameter: 6.0.4    配件页面 Accessories on page: 7.7.5 不同的电缆长度可根据实际需要, 在订货号的第三部分自行修改, 电缆长度单位: cm													



# M12 圆形连接器 ROUND PLUG CONNECTOR

M12 T-code

单端预铸线束  
屏蔽 Shield  
电源 Power

插针 Male  
直出 Straight

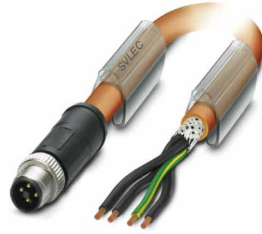

插孔 Female  
直出 Straight



插针 Male  
直出 Straight

插孔 Female  
直出 Straight



M12 T-Code

1	型号 Form No.	913044	913344	943044
极数 Suppression		4-pole	4-pole	4-pole
电路图 Circuit diagram				
针脚排序 Contact layout		插针 Male 	插孔 Female 	插针 Male      插孔 Female 
2	电缆类型 Cable type	护套颜色 Jacket color		
	导体横截面 4 x1.5mm <sup>2</sup>	橙 OG		
	PVC	902		
	PUR	901		
	技术参数 Technical data			
	额定电压 Supply voltage	60 V AC		
	额定电流 Current per contact (40°C)	12A		
	防护等级 Protection	IP67-插孔插针配合拧紧(EN 60529) When plugged and screwed down		
	温度范围 Temperature range	-25...+85°C		
3	电缆长度 Cable length			
	1.5m	0150		
	3.0m	0300		
	5.0m	0500		
	7.5m	0750		
	10.0m	1000		
	订货号 Part No.			
	可参考: 6.0.1 Reference: 6.0.1	例: <u>  913044  </u> — <u>  902  </u> — <u>  0500  </u>		
		<b>1</b> 型号 Form	<b>2</b> 电缆类型 Cable type	<b>3</b> 电缆长度 Cable length
备注 Notes	电缆参数 Cable parameter: 8.3.2    尺寸参数 Size parameter: 6.0.4    配件页面 Accessories on page: 7.7.5 不同的电缆长度可根据实际需要, 在订货号的第三部分自行修改, 电缆长度单位: cm			

# M12 圆形连接器 ROUND PLUG CONNECTOR

M12 K-code

插针 Male  
直出 Straight

插孔 Female  
直出 Straight

插针 Male 插孔 Female  
直出 Straight 直出 Straight

板面安装电源连接  
电源 Power



M12 K-code

<b>1</b>	<b>型号 Form</b>	<b>No.</b>	<b>912564</b>	<b>912464</b>	<b>942065</b>
	<b>极数</b> Suppression		5-pole	5-pole	5-pole
	<b>电路图</b> Circuit diagram				
	<b>针脚排序</b> Contact layout		<p>插针 Male</p>	<p>插孔 Female</p>	<p>插针 Male 插孔 Female</p>
<b>2</b>	<b>电缆类型 Cable type</b>	<b>护套颜色 Jacket color</b>			
	导体横截面 5 x 1.5mm <sup>2</sup>	黄 YE	黑 BK		
	PVC	961			
	PUR		962		
	<b>技术参数 Technical data</b>				
	额定电压 Supply voltage	630 V DC			
	额定电流 Current per contact (40°C)	12A			
	防护等级 Protection	IP67-插孔插针配合拧紧(EN 60529) When plugged and screwed down			
	温度范围 Temperature range	-25...+85°C			
<b>3</b>	<b>电缆长度 Cable length</b>				
	1.5m	0150			
	3.0m	0300			
	5.0m	0500			
	7.5m	0750			
	10.0m	1000			
	<b>订货号 Part No.</b>				
	可参考: 6.0.1 Reference: 6.0.1	例: <u>  912564  </u>	<u>  961  </u>	<u>  0500  </u>	
		<b>1</b> 型号 Form	<b>2</b> 电缆类型 Cable type	<b>3</b> 电缆长度 Cable length	
	<b>备注 Notes</b>				
		电缆参数 Cable parameter: 8.3.2 尺寸参数 Size parameter: 6.0.4 配件页面 Accessories on page: 7.7.5 不同的电缆长度可根据实际需要, 在订货号的第三部分自行修改, 电缆长度单位: cm			

# M12 圆形连接器 ROUND PLUG CONNECTOR

M12 T-code  
板面安装电源连接  
电源 Power

M12 插孔 Female  
直出 Straight

7/8" 插针 Male  
直出 Straight

M12 插针 Male  
直出 Straight

7/8" 插孔 Female  
直出 Straight

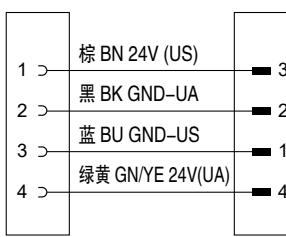

M12 T-Code

<b>1</b>	<b>型号 Form</b>	<b>No.</b>	<b>942071</b>	<b>942074</b>
	<b>极数</b> Suppression		4-pole	4-pole
	<b>电路图</b> Circuit diagram			
	<b>针脚排序</b> Contact layout		<p>插孔 Female      插针 Male</p> 	<p>插针 Male      插孔 Female</p> 
<b>2</b>	<b>电缆类型 Cable type</b>	<b>护套颜色 Jacket color</b>		
	导体横截面 4 x1.5mm <sup>2</sup>	黄 YE		
	PUR	960		
	<b>技术参数 Technical data</b>			
	额定电压 Supply voltage	60 V DC		
	额定电流 Current per contact (40°C)	9 A		
	防护等级 Protection	IP67-插孔插针配合拧紧(EN 60529) When plugged and screwed down		
	温度范围 Temperature range	-25...+85°C		
<b>3</b>	<b>电缆长度 Cable length</b>			
	1.5m	0150		
	3.0m	0300		
	5.0m	0500		
	7.5m	0750		
	10.0m	1000		
	<b>订货号 Part No.</b>			
	可参考: 6.0.1 Reference: 6.0.1	例: <u>    942071    </u> - <u>    960    </u> - <u>    0500    </u>		
		<b>1</b>	<b>型号 Form</b>	<b>2</b>
			<b>电缆类型 Cable type</b>	<b>3</b>
			<b>电缆长度 Cable length</b>	
	<b>备注 Notes</b>			
		电缆参数 Cable parameter: 8.3.2 尺寸参数 Size parameter: 6.0.4 配件页面 Accessories on page: 7.7.5 不同的电缆长度可根据实际需要, 在订货号的第三部分自行修改, 电缆长度单位: cm		

# M12 圆形连接器 ROUND PLUG CONNECTOR

M12 T-code

板面安装电源连接

电源 Power

屏蔽 Shielded

M12 插针 Male  
直出 Straight

7/8" 插孔 Female  
直出 Straight

M12 插孔 Female  
直出 Straight

7/8" 插针 Male  
直出 Straight



## 1 型号 Form No. 943071 943074

极数  
Suppression

4-pole

4-pole

电路图  
Circuit diagram



针脚排序  
Contact layout

插针 Male 插孔 Female

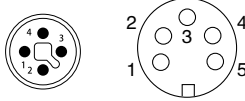

插孔 Female 插针 Male

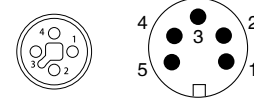

## 2 电缆类型 Cable type 护套颜色 Jacket color

导体横截面 4 x1.5mm<sup>2</sup>

橙 OG

PVC

902

PUR

901

技术参数 Technical data

额定电压 Supply voltage

60 V DC

额定电流 Current per contact (40°C)

9 A

防护等级 Protection

IP67-插孔插针配合拧紧(EN 60529) When plugged and screwed down

温度范围 Temperature range

-25...+85°C

## 3 电缆长度 Cable length

1.5m

0150

3.0m

0300

5.0m

0500

7.5m

0750

10.0m

1000

订货号 Part No.

可参考: 6.0.1  
Reference: 6.0.1

例:   943071   -   902   -   0500  

**1** 型号 Form **2** 电缆类型 Cable type **3** 电缆长度 Cable length

备注 Notes

电缆参数 Cable parameter: 8.3.2 尺寸参数 Size parameter: 6.0.4 配件页面 Accessories on page: 7.7.5  
不同的电缆长度可根据实际需要, 在订货号的第三部分自行修改, 电缆长度单位: cm

# M12 圆形连接器 ROUND PLUG CONNECTOR

M12 L-code  
 板面安装电源连接  
 电源 Power

M12 插孔 Female  
 直出 Straight

7/8" 插针 Male  
 直出 Straight

M12 插针 Male  
 直出 Straight

7/8" 插孔 Female  
 直出 Straight



M12 L-Code

<b>1</b>	<b>型号 Form</b>	<b>No.</b>	<b>942075</b>	<b>942076</b>
	<b>极数</b> Suppression		5-pole	5-pole
	<b>电路图</b> Circuit diagram			
	<b>针脚排序</b> Contact layout		插孔 Female      插针 Male 	插针 Male      插孔 Female 
<b>2</b>	<b>电缆类型 Cable type</b>	<b>护套颜色 Jacket color</b>		
	导体横截面 5 x 1.5mm <sup>2</sup>	黄 YE	黑 BK	
	PVC	961		
	PUR		962	
	<b>技术参数 Technical data</b>			
	额定电压 Supply voltage	60 V DC		
	额定电流 Current per contact (40°C)	9 A		
	防护等级 Protection	IP67-插孔插针配合拧紧(EN 60529) When plugged and screwed down		
	温度范围 Temperature range	-25...+85°C		
<b>3</b>	<b>电缆长度 Cable length</b>			
	1.5m	0150		
	3.0m	0300		
	5.0m	0500		
	7.5m	0750		
	10.0m	1000		
	<b>订货号 Part No.</b>			
	可参考: 6.0.1 Reference: 6.0.1	例: <u>    942071    </u> — <u>    960    </u> — <u>    0500    </u>		
		<b>1</b>	<b>2</b>	<b>3</b>
		型号 Form	电缆类型 Cable type	电缆长度 Cable length
	<b>备注 Notes</b>			
		电缆参数 Cable parameter: 8.3.2    尺寸参数 Size parameter: 6.0.4    配件页面 Accessories on page: 7.7.5 不同的电缆长度可根据实际需要, 在订货号的第三部分自行修改, 电缆长度单位: cm		

# 板前安装连接器

S-Code  
T-Code  
L-Code  
K-Code  
电源 Power

插针 Male



插孔 Female



1	焊接型订货号 Part No.	913507	913508	913547	913548
	现场焊接型订货号 Part No.	913507S	913508S	913547S	913548S
		<b>S-Code</b>	<b>T-Code</b>	<b>S-Code</b>	<b>T-Code</b>
	极数 Suppression	4-pole	4-pole	4-pole	4-pole
<b>技术参数 Technical data</b>					
额定电压 Supply voltage	630 V AC	60 V AC	630 V AC	60 V AC	
额定电流 Current per contact (40°C)	12A	12A	12A	12A	
防护等级 Protection	IP67-插孔插针配合拧紧(EN 60529) When plugged and screwed down				
温度范围 Temperature range	-25...+85°C				
1	焊接型订货号 Part No.	913527	913526	913567	913566
	现场焊接型订货号 Part No.	913527S	913526S	913567S	913566S
		<b>L-Code</b>	<b>K-Code</b>	<b>L-Code</b>	<b>K-Code</b>
	极数 Suppression	5-pole	5-pole	5-pole	5-pole
<b>技术参数 Technical data</b>					
额定电压 Supply voltage	63 V DC	630 V AC	63 V DC	630 V AC	
额定电流 Current per contact (40°C)	12A	12A	12A	12A	
防护等级 Protection	IP67-插孔插针配合拧紧(EN 60529) When plugged and screwed down				
温度范围 Temperature range	-25...+85°C				
2	螺母固定 Suitable mounting nut	默认为 M16 螺母: 971 (M16), 量大可选: 974(M12), 977(PG9), 979(M20), 制作带 T 料号需有对应规格书。			
	订货号 Part No.				
		例: <u>  913507  </u> — <u>  971  </u> — <u>  0050  </u>			
		<b>1</b> 型号 Form	<b>2</b> 螺母类型 Nut type	<b>3</b> 电缆长度 Cable length	
<b>备注 / Notes</b>					
配件页面 Accessories on page: 7.7.5					

# 板后安装连接器

S-Code  
T-Code  
L-Code  
K-Code  
电源 Power

插针 Male



插孔 Female



1	焊接型订货号 Part No.	913517	913518	913537	913538
	现场焊线型订货号 Part No.	913517S	913518S	913537S	913538S
		<b>S-Code</b>	<b>T-Code</b>	<b>S-Code</b>	<b>T-Code</b>
	极数 Suppression	4-pole	4-pole	4-pole	4-pole
<b>技术参数 Technical data</b>					
	额定电压 Supply voltage	630 V AC	60 V AC	630 V AC	60 V AC
	额定电流 Current per contact (40°C)	12A	12A	12A	12A
	防护等级 Protection	IP67-插孔插针配合拧紧(EN 60529) When plugged and screwed down			
	温度范围 Temperature range	-25...+85°C			
1	焊接型订货号 Part No.	913535	913536	913557	913558
	现场焊线型订货号 Part No.	913535S	913536S	913557S	913558S
		<b>L-Code</b>	<b>K-Code</b>	<b>L-Code</b>	<b>K-Code</b>
	极数 Suppression	5-pole	5-pole	5-pole	5-pole
<b>技术参数 Technical data</b>					
	额定电压 Supply voltage	63 V DC	630 V AC	63 V DC	630 V AC
	额定电流 Current per contact (40°C)	12A	12A	12A	12A
	防护等级 Protection	IP67-插孔插针配合拧紧(EN 60529) When plugged and screwed down			
	温度范围 Temperature range	-25...+85°C			
2	螺母固定 Suitable mounting nut	默认为 M16 螺母: 971 (M16), 量大可选: 974(M12), 977(PG9), 979(M20), 制作带 T 料号需有对应规格书。			
	订货号 Part No.				
	例:	<div style="display: flex; justify-content: space-around; align-items: center;"> <span>913517</span> <span>—</span> <span>971</span> <span>—</span> <span>0050</span> </div>			
		1 型号 Form	2 螺母类型 Nut type	3 电缆长度 Cable length	
<b>备注 / Notes</b>					
配件页面 Accessories on page: 7.7.5					

# 7/8" 圆形连接器 ( 现场总线 ) ROUND PLUG CONNECTOR

现场接线  
Field-wireable

螺钉压接  
With screw terminals

电源 Power

插针 Male  
直出线 Straight



插孔 Female  
直出线 Straight



<b>1</b>	<b>型号 Form</b>	<b>No.</b>	<b>978101</b>	<b>978081</b>	<b>978221</b>	<b>978201</b>
----------	----------------	------------	---------------	---------------	---------------	---------------

<b>极数</b> Suppression	4-pole	5-pole	4-pole	5-pole
--------------------------	--------	--------	--------	--------

插针 Male  
90°



插孔 Female  
90°



<b>型号 Form</b>	<b>No.</b>	<b>978142</b>	<b>978141</b>	<b>978262</b>	<b>978261</b>
----------------	------------	---------------	---------------	---------------	---------------

<b>极数</b> Suppression	4-pole	5-pole	4-pole	5-pole
--------------------------	--------	--------	--------	--------

**电路图**  
Circuit diagram

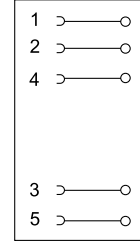
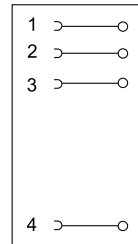
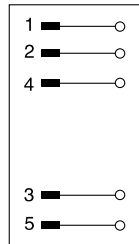
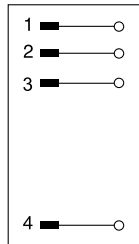

电缆出线直径 Clamping range screw thread 8...14mm

**针脚排序**  
Contact layout

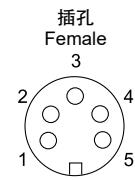
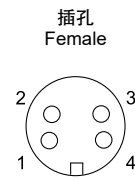
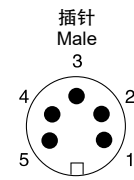
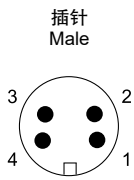

## 2 技术参数 Technical data

额定电压 Supply voltage	600 V AC/DC
额定电流 Current per contact ( 40°C )	max. 8A
压线方式 Wiring method	螺钉压接 Screw terminals
防护等级 Protection	IP67- 插孔插针配合拧紧 ( EN 60529 ) When plugged and screwed down
温度范围 Temperature range	-25...+85°C
螺钉压线范围 Connection diameter	1.5mm <sup>2</sup>

**订货号 Part No.**

可参考: 6.0.1  
Reference: 6.0.1

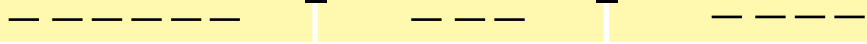

**1** 型号 Form

备注 Notes

配件及技术参数页面 Accessories and technical page: 7.2.5

7/8" 圆形连接器



# 7/8" 圆形连接器 ( 现场总线 ) ROUND PLUG CONNECTOR

7/8" 单端预铸线束  
With open ended wires

电源 Power

插孔 Female  
直出 Straight



插孔 Female  
90°



1	型号 Form	No.	978161	978041	978021	978111	978061	978051
	极数 Suppression		3-pole	4-pole	5-pole	3-pole	4-pole	5-pole
			插针 Male 直出 Straight			插针 Male 90°		
								
	型号 Form	No.	978171	978011	978031	978191	978071	978091
	极数 Suppression		3-pole	4-pole	5-pole	3-pole	4-pole	5-pole
	电路图 Circuit diagram							
	针脚排序 Contact layout							
2	电缆类型 Cabel type	护套颜色 Jacket color						
	导体横截面 1.5mm <sup>2</sup>		黄 YE	黄 YE	黄 YE	黄 YE	黄 YE	黄 YE
			963	960	961	963	960	961
3	电缆长度 Cabel length							
	1.5 m	0150						
	3.0 m	0300						
	5.0 m	0500						
	7.5 m	0750						
	10.0 m	1000						
订货号 Part No.								
可参考: 6.0.1 Reference: 6.0.1		例: <u>    978161    </u> - <u>    963    </u> - <u>    0500    </u>						
		1 型号 Form		2 电缆类型 Cable type		3 电缆长度 Cable length		

备注 Notes

电缆参数 Cable parameter: 8.3.2 尺寸参数 Size parameter: 6.0.4 配件页面 Accessories on page: 7.2.5  
不同的电缆长度可根据实际需要, 在订货号的第三部分自行修改, 电缆长度单位: cm

# 7/8" 圆形连接器 ( 现场总线 ) ROUND PLUG CONNECTOR

7/8" 双端预铸线束  
Connection cable

电源 Power

插针 Male  
直出 Straight

插孔 Female  
直出 Straight

插针 Male  
90°

插孔 Female  
90°



1 型号 Form No.	950120	950020	950021	950150	950050	950051
极数 Suppression	3-pole	4-pole	5-pole	3-pole	4-pole	5-pole
电路图 Circuit diagram						
针脚排序 Contact layout						
2 电缆类型 Cable type	护套颜色 Jacket color					
	黄 YE	黄 YE	黄 YE	黄 YE	黄 YE	黄 YE
导体横截面 1.5mm <sup>2</sup>	963	960	961	963	960	961
3 电缆长度 Cable length						
0.3 m	0030					
0.6 m	0060					
1.0 m	0100					
1.5 m	0150					
2.0 m	0200					
订货号 Part No.						
可参考: 6.0.1 Reference: 6.0.1	例: <u>    950120    </u> - <u>    963    </u> - <u>    0500    </u>					
	1 型号 Form		2 电缆类型 Cable type		3 电缆长度 Cable length	
备注 Notes	电缆参数 Cable parameter: 8.3.2 尺寸参数 Size parameter: 6.0.4 配件页面 Accessories on page: 7.2.5 不同的电缆长度可根据实际需要, 在订货号的第三部分自行修改, 电缆长度单位: cm					

7/8" 圆形连接器

# 7/8" 圆形连接器 (现场总线) ROUND PLUG CONNECTOR





带线或 PCB 安装  
Pre-wired or PCB installation

7/8" 插针 Male

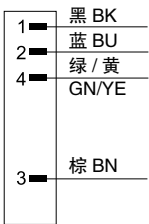
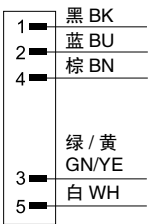

7/8" 插孔 Female

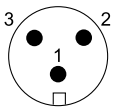
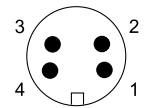
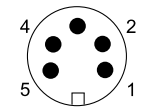
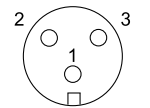
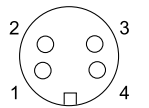
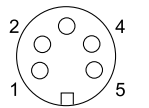
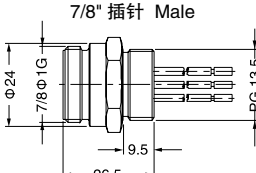
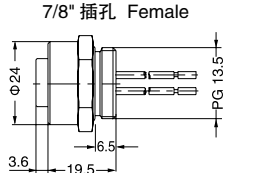
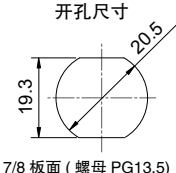

1	型号 Form No.	978311	978331	978341	978361	978351	978381
极数 Suppression		3-pole	4-pole	5-pole	3-pole	4-pole	5-pole
电路图 Circuit diagram							
针脚排序 Contact layout							
2	螺母固定 Suitable mounting nut	986 (PG13.5 螺母)					
							
3	技术参数 Technical data	额定电压 Supply voltage: 250V AC/DC 额定电流 Current per contact (40°C): 10A 防护等级 Protection: IP67- 插孔插针配合拧紧 (EN60529) When plugged and screwed down 导体截面积 Connection diameter: 1.5mm <sup>2</sup> 温度范围 Temperature range: -25...+85 °C					
	订货号 Part No.	例: <u>      978311      </u> - <u>      986      </u> - <u>      0050      </u>					
	PCB 安装产品订购 只需填写型号 PCB product installation order only need to fill in the model	1 型号 Form      2 螺母类型 Nut type      3 电缆长度 Cable length					
备注 Notes	配件页面 Accessories on page: 7.2.5 不同的电缆长度可根据实际需要, 在订货号的第三部分自行修改, 电缆长度单位: cm						

# 附件 ACCESSORIES

7/8" 圆形连接器

标识附件 Labeling accessories		适用范围 suitable for	订货号 Part No.
	滑动电缆套管 Slip-on cable sleeves 4x18 mm	电缆直径 4.0...6.5mm Cable diameter 4.0...6.5 mm	990000
	可拆卸电缆套管 Snap-on cable sleeves 4x18 mm	电缆直径 4.2...7.0mm Cable diameter 4.2...7.0 mm	990001
	标识板 Label plates 4x18 mm		990002
保护盖 Protection cover 	7/8" 插针保护盖 (金属) Male protection cover (metal)		955491
保护盖 Protection cover 	7/8" 插孔保护盖 (金属) Female protection cover (metal)		955691
保护盖 Protection cover 	7/8" 插针保护盖 (塑料) Male protection cover (plastic)		955490
	7/8" 插孔保护盖 (塑料) Female protection cover (plastic)		955690

## 7/8" 圆形连接器 直出线 Round plug connector Straight / 90°

插针 Male 直出 Straight

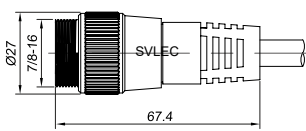

单端预铸线束 With open ended wires

插针 Male 90°

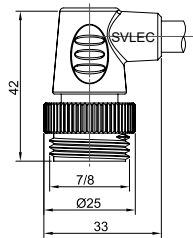

插孔 Female 直出 Straight

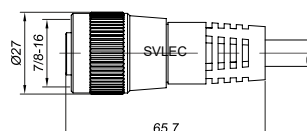

插孔 Female 90°

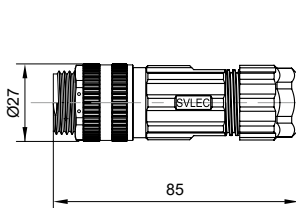
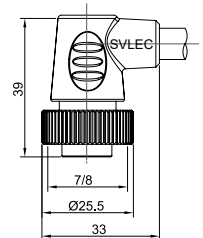

现场接线 / 螺钉压接  
Field-wireable / screw terminals

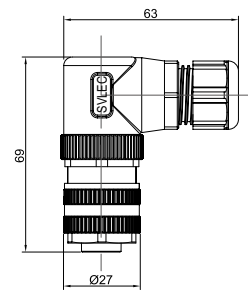
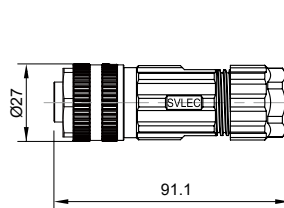
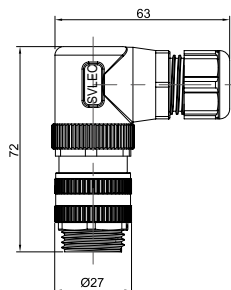







M12 单端预铸线束  
 With open ended wires M12  
 屏蔽 B-Coded  
 Shielded, B-coded

插针 Male  
 直出 Straight



插孔 Female  
 直出 Straight

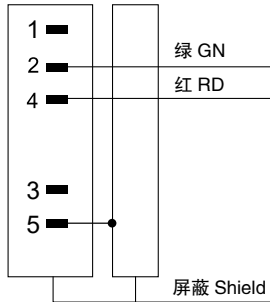
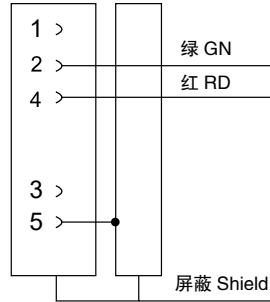

1	型号 Form No.	914051	914061
	极数 Suppression	2-pole	2-pole
	插针 Male 90°		插孔 Female 90° 
	型号 Form No.	914081	914071
	极数 Suppression	2-pole	2-pole
	电路图 Circuit diagram		
	针脚排序 Contact layout	插针 Male 	插孔 Female 
	2 电缆类型 Cable type	护套颜色 Jacket color	
	芯线 Wire 1x2xØ0.64mm	紫 VT	紫 VT
	PVC 固定安装 Fixed installation	840	840
	PUR 高柔性 Highly flexible	841	841
3	3 电缆长度 Cable length		
	1.5m	0150	
	3.0m	0300	
	5.0m	0500	
	7.5m	0750	
	10.0m	1000	
订货号 Part No.			
可参考: 6.0.1 Reference: 6.0.1		例: <u>    914051    </u> - <u>    840    </u> - <u>    0500    </u>	
		1 型号 Form	2 电缆类型 Cable type
			3 电缆长度 Cable length

Profibus 现场总线

备注 Notes

电缆参数 Cable parameter: 8.3.2 尺寸参数 Size parameter: 6.0.4 配件页面 Accessories on page: 7.7.5  
 不同的电缆长度可根据实际需要, 在订货号的第三部分自行修改, 电缆长度单位: cm

# 现场总线连接器 PLUG CONNECTORS FOR FIELDBUS TECHNOLOGY



M12 双端预铸线束  
Connection cable M12

屏蔽 B-Coded  
Shielded, B-coded

插针 Male  
直出 Straight

插孔 Female  
直出 Straight

插针 Male  
90°

插孔 Female  
90°



<b>1</b>	<b>型号 Form</b>	<b>No.</b>	<b>944001</b>	<b>944021</b>
----------	----------------	------------	---------------	---------------

极数  
Suppression

2-pole

2-pole

电路图  
Circuit diagram

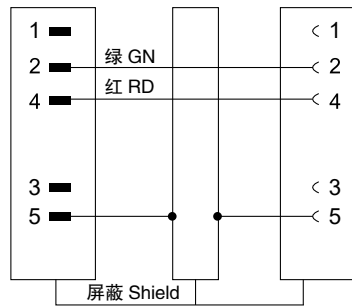

针脚排序  
Contact layout

插针 Male      插孔 Female

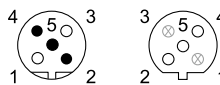

<b>2</b>	<b>电缆类型 Cable type</b>	<b>护套颜色 Jacket color</b>
----------	------------------------	--------------------------

芯线 Wire 1x2xØ0.64mm

紫 VT

PVC 固定安装 Fixed installation

840

PUR 高柔性 Highly flexible

841

<b>3</b>	<b>电缆长度 Cable length</b>
----------	--------------------------

0.3m

0030

0.6m

0060

1.0m

0100

1.5m

0150

2.0m

0200

订货号 Part No.

可参考: 6.0.1  
Reference: 6.0.1

例:     944001     -     840     -     0500    

**1** 型号 Form      **2** 电缆类型 Cable type      **3** 电缆长度 Cable length

备注 Notes

电缆参数 Cable parameter: 8.3.2    尺寸参数 Size parameter: 6.0.4    配件页面 Accessories on page: 7.7.5  
不同的电缆长度可根据实际需要, 在订货号的第三部分自行修改, 电缆长度单位: cm



M12 单端预铸线束  
With open ended wires M12  
屏蔽 Shielded

插针 Male  
直出 Straight



插孔 Female  
直出 Straight



<b>1</b>	<b>型号 Form</b>	<b>No.</b>	<b>913105</b>	<b>913225</b>
----------	----------------	------------	---------------	---------------

极数 Suppression

5-pole

5-pole

插针 Male  
90°



插孔 Female  
90°



型号 Form

No.

**913125**

**913251**

极数 Suppression

5-pole

5-pole

电路图

Circuit diagram

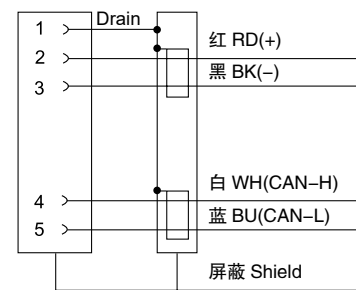
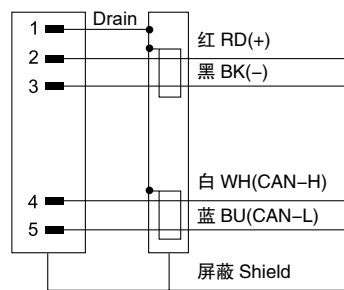

引脚排序

Contact layout

插针 Male



插孔 Female

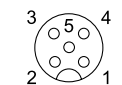

<b>2</b>	<b>电缆类型 Cable type</b>	<b>护套颜色 Jacket color</b>		
----------	------------------------	--------------------------	--	--

DeviceNet 细缆 Cable Thin

紫 VT

紫 VT

固定安装 Fixed installation

807

807

拖链、抗扭 Highly flexible , Torsion

803

803

<b>3</b>	<b>电缆长度 Cable length</b>		
----------	--------------------------	--	--

1.5m

0150

3.0m

0300

5.0m

0500

7.5m

0750

10.0m

1000

订货号 Part No.

可参考: 6.0.1  
Reference: 6.0.1

例:   913105   —   809   —   0500  

**1** 型号 Form      **2** 电缆类型 Cable type      **3** 电缆长度 Cable length

备注 Notes

电缆参数 Cable parameter: 8.3.2 尺寸参数 Size parameter: 6.0.4 配件页面 Accessories on page: 7.7.5  
不同的电缆长度可根据实际需要, 在订货号的第三部分自行修改, 电缆长度单位: cm

# 现场总线连接器



M12 双端预铸线束  
Connection cable M12  
屏蔽 Shielded

插针 Male  
直出 Straight

插孔 Female  
直出 Straight

插针 Male  
90°

插孔 Female  
90°



<b>1</b>	<b>型号 Form</b>	<b>No.</b>	<b>940531</b>	<b>940551</b>
	极数 Suppression		5-pole	5-pole
	电路图 Circuit diagram			
	针脚排序 Contact layout	<div style="display: flex; justify-content: space-around;"> <div style="text-align: center;"> <p>插针 Male</p> </div> <div style="text-align: center;"> <p>插孔 Female</p> </div> </div>		
<b>2</b>	<b>电缆类型 Cable type</b>	<b>护套颜色 Jacket color</b>		
	DeviceNet 细缆 Cable Thin	紫 VT		
	固定安装 Fixed installation	807		
	拖链、抗扭 Highly flexible, Torsion	803		
<b>3</b>	<b>电缆长度 Cable length</b>			
	1.5m	0150		
	3.0m	0300		
	5.0m	0500		
	7.5m	0750		
	10.0m	1000		
	<b>订货号 Part No.</b>			
	可参考: 6.0.1 Reference: 6.0.1	例: <u>  940531  </u> — <u>  809  </u> — <u>  0500  </u>		
		<b>1</b>	<b>2</b>	<b>3</b>
		型号 Form	电缆类型 Cable type	电缆长度 Cable length
	<b>备注 Notes</b>	电缆参数 Cable parameter: 8.3.2 尺寸参数 Size parameter: 6.0.4 配件页面 Accessories on page: 7.7.5 不同的电缆长度可根据实际需要, 在订货号的第三部分自行修改, 电缆长度单位: cm		

DeviceNet 现场总线



# 现场总线连接器 PLUG CONNECTORS FOR FIELDBUS TECHNOLOGY





7/8" 单端预铸线束  
 With open ended wires

插针 Male  
 直出 Straight



插孔 Female  
 直出 Straight

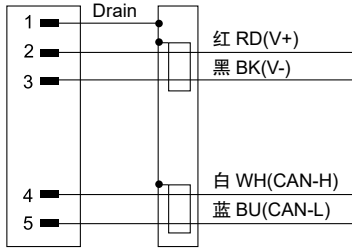
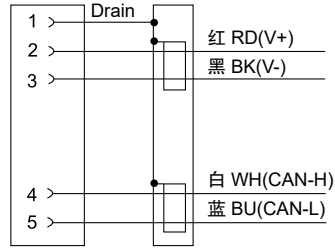
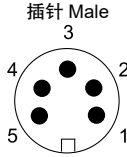
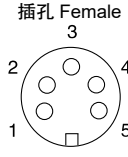

1	型号 Form	No. 978131	978121
	极数 Suppression	5-pole	5-pole
	插针 Male 90°		插孔 Female 90° 
	型号 Form	No. 978181	978151
	极数 Suppression	5-pole	5-pole
	电路图 Circuit diagram		
	针脚排序 Contact layout		
2	电缆类型 Cable type	护套颜色 Jacket color	
	DeviceNet 粗缆 Cable Thick	灰 GY	灰 GY
	固定安装 Fixed installation	809	809
	DeviceNet 细缆 Cable Thin	紫 VT	紫 VT
	固定安装 Fixed installation	807	807
拖链、抗扭 Highly flexible, Torsion	803	803	
3	电缆长度 Cable length		
	1.5 m	0150	
	3.0 m	0300	
	5.0 m	0500	
	7.5 m	0750	
	10.0 m	1000	
订货号 Part No.			
可参考: 6.0.1 Reference: 6.0.1	例: <u>  978121  </u> — <u>  809  </u> — <u>  0500  </u>		
	1 型号 Form	2 电缆类型 Cable type	3 电缆长度 Cable length
备注 Notes			
电缆参数 Cable parameter: 8.3.2 尺寸参数 Size parameter: 6.0.4 配件页面 Accessories on page: 7.7.5 不同的电缆长度可根据实际需要, 在订货号的第三部分自行修改, 电缆长度单位: cm			

# 现场总线连接器 PLUG CONNECTORS FOR FIELDBUS TECHNOLOGY



7/8" 双端预铸线束  
Connection cable

插针 Male  
直出 Straight

插孔 Female  
直出 Straight

插针 Male  
90°

插孔 Female  
90°



<b>1</b>	<b>型号 Form</b>	<b>No.</b>	<b>950121</b>	<b>950151</b>
	<b>极数</b> Suppression		5-pole	5-pole
	<b>电路图</b> Circuit diagram			
	<b>针脚排序</b> Contact layout			
<b>2</b>	<b>电缆类型 Cable type</b>	<b>护套颜色 Jacket color</b>		
	DeviceNet 粗缆 Cable Thick	灰 GY		
	固定安装 Fixed installation	809		
	DeviceNet 细缆 Cable Thin	紫 VT		
	固定安装 Fixed installation	807		
	拖链、抗扭 Highly flexible, Torsion	803		
<b>3</b>	<b>电缆长度 Cable length</b>			
	0.3 m	0030		
	0.6 m	0060		
	1.0 m	0100		
	1.5 m	0150		
	2.0 m	0200		
	<b>订货号 Part No.</b>			
	可参考: 6.0.1 Reference: 6.0.1	例: <u>  950121  </u> - <u>  809  </u> - <u>  0500  </u>		
	<b>1</b> 型号 Form	<b>2</b> 电缆类型 Cable type	<b>3</b> 电缆长度 Cable length	
	<b>备注 Notes</b>	电缆参数 Cable parameter: 8.3.2 尺寸参数 Size parameter: 6.0.4 配件页面 Accessories on page: 7.7.5 不同的电缆长度可根据实际需要, 在订货号的第三部分自行修改, 电缆长度单位: cm		

DeviceNet 现场总线

# 现场总线连接器 PLUG CONNECTORS FOR FIELDBUS TECHNOLOGY



7/8" 板端预铸线束  
With open ended wires

插针 Male  
直出 Straight

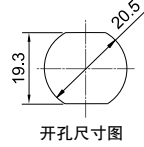

插孔 Female  
直出 Straight



<b>1</b>	型号 Form	No. <b>978501</b>	<b>978521</b>
	极数 Suppression	5-pole	5-pole
	电路图 Circuit diagram		
	针脚排序 Contact layout	<p>插针 Male</p>	<p>插孔 Female</p>
<b>2</b>	电缆类型 Cable type	护套颜色 Jacket color	
	DeviceNet 粗缆 Cable Thick	灰 GY	
	固定安装 Fixed installation	809	
	DeviceNet 细缆 Cable Thin	紫 VT	
	固定安装 Fixed installation	807	
	拖链、抗扭 Highly flexible, Torsion	803	
<b>3</b>	电缆长度 Cable length		
	0.3 m	0030	
	0.6 m	0060	
	1.0 m	0100	
	1.5 m	0150	
	2.0 m	0200	
	订货号 Part No.		
	可参考: 6.0.1 Reference: 6.0.1	<p>例: <u>  978501  </u> — <u>  809  </u> — <u>  0500  </u></p>	
	<b>1</b> 型号 Form	<b>2</b> 电缆类型 Cable type	<b>3</b> 电缆长度 Cable length
备注 Notes	电缆参数 Cable parameter: 8.3.2 尺寸参数 Size parameter: 6.0.4 配件页面 Accessories on page: 7.7.5 不同的电缆长度可根据实际需要, 在订货号的第三部分自行修改, 电缆长度单位: cm		

# 现场总线 PROFINET-TECHNOLOGY

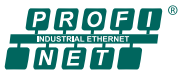

FESTO 阀岛

预铸线束  
Connection cable

屏蔽 Shielded

插针 Male  
M8 D-Code  
直出 Straight



插针 Male  
M8 D-Code  
直出 Straight



插针 Male  
M8 D-Code  
直出 Straight

插针 Male  
M8 D-Code  
直出 Straight

插孔 Female  
M8 A-Code  
直出 Straight



1	型号 Form No.	988800	988802	988803
极数 Suppression		4-pole	4-pole	4-pole
电路图 Circuit diagram				
针脚排序 Contact layout		<p>插针 Male</p>	<p>插针 Male 插针 Male</p>	<p>插针 Male 插孔 Female</p>
2	电缆类型 Cable type	护套颜色 Jacket color		
	Profinet 2x2x22AWG	绿 GN		
	固定安装 Fixed installation Type	794		
	拖链、抗扭 Highly flexible, torsion Type	796		
3	电缆长度 Cable length			
	1.5m	0150		
	3.0m	0300		
	5.0m	0500		
	7.5m	0750		
	10.0m	1000		
	订货号 Part No.			
	可参考: 6.0.1 Reference: 6.0.1	例: 988802 - 790 - 0500		
		1 型号 Form	2 电缆类型 Cable type	3 电缆长度 Cable length
备注 Notes	电缆参数 Cable parameter: 8.3.2 尺寸参数 Size parameter: 6.0.4 配件页面 Accessories on page: 7.7.5 不同的电缆长度可根据实际需要, 在订货号的第三部分自行修改, 电缆长度单位: cm			

Profinet 现场总线



CAT.5e  
M8 预铸线束  
屏蔽 Shielded

插针 Male M8  
直出 Straight



插针 Male M8  
直出 Straight



插针 Male M8  
直出 Straight

<b>1</b>	型号 Form	No.	<b>989701</b>	<b>988701</b>
----------	---------	-----	---------------	---------------

极数 Suppression

4-pole

4-pole

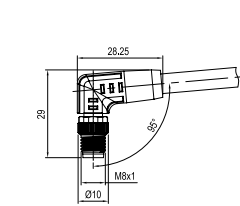

插针 Male M8  
90°



插针 Male M8  
90°



插针 Male M8  
90°

	型号 Form	No.	<b>989721</b>	<b>988721</b>
--	---------	-----	---------------	---------------

极数 Suppression

4-pole

4-pole

针脚排序  
Contact layout

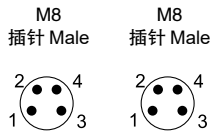

电路图  
Circuit diagram

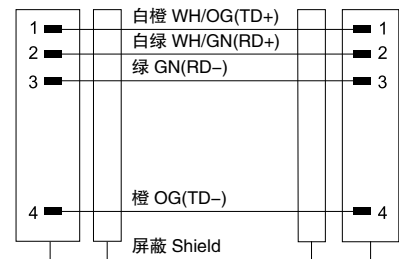
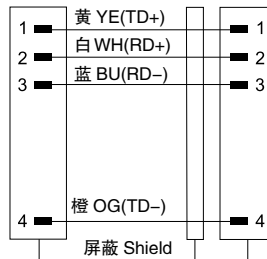

2x2x22AWG & 2x2x24AWG

2x2x26AWG

<b>2</b>	电缆类型 Cable type	护套颜色 Jacket color
----------	-----------------	-------------------

Profinet ( 2x2x22AWG )	绿 GN	
固定安装 Fixed installation TypeA	794	
拖链、抗扭 Highly flexible , torsion TypeC	796	
CAT 5e. (2x2x24AWG)		蓝 BU
固定安装 Flexible installation PVC	795	782
拖链安装 Highly flexible PUR	797	
CAT 5e. (2x2x26AWG)		
固定安装 Flexible installation PVC		791
拖链安装 Highly flexible PUR		793

<b>3</b>	电缆长度 Cable length	
----------	-------------------	--

1.5m	0150	
3.0m	0300	
5.0m	0500	
7.5m	0750	
10.0m	1000	

订货号 Part No.	
--------------	--

可参考: 6.0.1  
Reference: 6.0.1

例:   989701   -   794   -   0500  

**1** 型号 Form      **2** 电缆类型 Cable type      **3** 电缆长度 Cable length

备注 Notes	
----------	--

电缆参数 Cable parameter: 8.3.2 尺寸参数 Size parameter: 6.0.4 配件页面 Accessories on page: 7.7.5  
不同的电缆长度可根据实际需要, 在订货号的第三部分自行修改, 电缆长度单位: cm

# 工业以太网技术 ETHERNET-TECHNOLOGY



CAT.5e  
M8 预铸线束  
屏蔽 Shielded

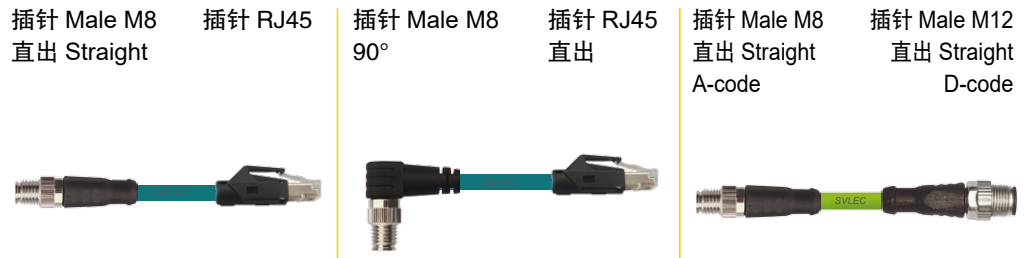

<b>1</b>	刺破型号 Form No.	<b>934911</b>	<b>934912</b>	<b>944901</b>
	包胶型号 Form No.	934911Y	934912Y	
	极数 Suppression	4-pole	4-pole	4-pole

针脚排序  
Contact layout

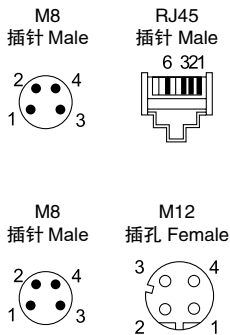

电路图  
Circuit diagram

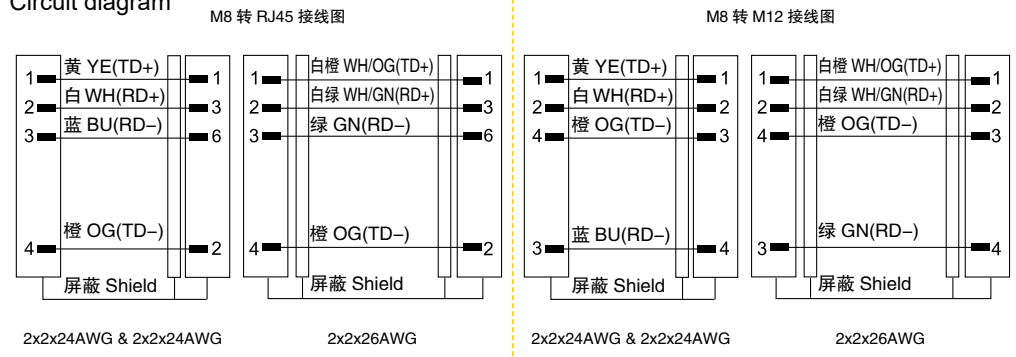

2	电缆类型 Cable type	护套颜色 Jacket color
	Profinet (2x2x22AWG)	绿 GN
	固定安装 Fixed installation TypeA	794
	拖链、抗扭 Highly flexible, torsion TypeC	796
	CAT 5e. (2x2x24AWG)	蓝 BU
	固定安装 Flexible installation PVC	795
	拖链安装 Highly flexible PUR	782
	CAT 5e. (2x2x26AWG)	
	固定安装 Flexible installation PVC	791
	拖链安装 Highly flexible PUR	793

3	电缆长度 Cable length	
	1.5m	0150
	3.0m	0300
	5.0m	0500
	7.5m	0750
	10.0m	1000

订货号 Part No.			
可参考: 6.0.1 Reference: 6.0.1	例: <u>934911</u>	- <u>794</u>	- <u>0500</u>
	<b>1</b> 型号 Form	<b>2</b> 电缆类型 Cable type	<b>3</b> 电缆长度 Cable length

备注 Notes  
电缆参数 Cable parameter: 8.3.2 尺寸参数 Size parameter: 6.0.4 配件页面 Accessories on page: 7.7.5  
不同的电缆长度可根据实际需要, 在订货号的第三部分自行修改, 电缆长度单位: cm

CAT.5e 现场总线



CAT.5e  
M12 预铸线束  
屏蔽 Shielded, D-Code

插针 Male M12  
直出 Straight



插针 Male M12  
直出 Straight



插针 Male M12  
直出 Straight

<b>1</b>	<b>型号 Form</b>	<b>No.</b>	<b>914541</b> (曾用料号: 944873)	<b>944511</b> (曾用料号: 944521)
----------	----------------	------------	------------------------------	------------------------------

<b>极数 Suppression</b>	4-pole	4-pole
-----------------------	--------	--------

	插针 Male M12 90°	插针 Male M12 90°	插针 Male M12 90°
--	--------------------	--------------------	--------------------



	<b>型号 Form</b>	<b>No.</b>	<b>914561</b>	<b>944561</b>
--	----------------	------------	---------------	---------------

<b>极数 Suppression</b>	4-pole
-----------------------	--------

**针脚排序**  
Contact layout

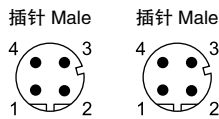

**电路图**  
Circuit diagram

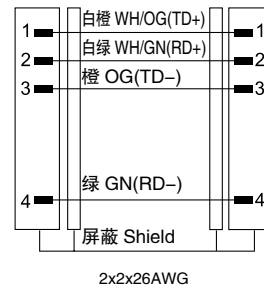
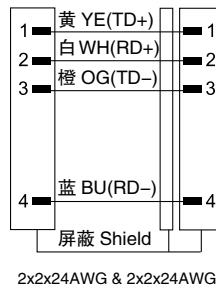

<b>2</b>	<b>电缆类型 Cable type</b>	<b>护套颜色 Jacket color</b>
----------	------------------------	--------------------------

Profinet (2x2x22AWG)	绿 GN	
固定安装 Fixed installation TypeA	790	
拖链、抗扭 Highly flexible, torsion TypeC	796	
CAT 5e. (2x2x24AWG)		蓝 BU
固定安装 Flexible installation PVC	795	782
拖链安装 Highly flexible PUR	797	
CAT 5e. (2x2x26AWG)		
固定安装 Flexible installation PVC		791
拖链安装 Highly flexible PUR		793

<b>3</b>	<b>电缆长度 Cable length</b>
----------	--------------------------

1.5m	0150
3.0m	0300
5.0m	0500
7.5m	0750
10.0m	1000

<b>订货号 Part No.</b>
---------------------

可参考: 6.0.1  
Reference: 6.0.1

例:   914541   -   790   -   0500  

**1** 型号 Form      **2** 电缆类型 Cable type      **3** 电缆长度 Cable length

<b>备注 Notes</b>
-----------------

电缆参数 Cable parameter: 8.3.2 尺寸参数 Size parameter: 6.0.4 配件页面 Accessories on page: 7.7.5  
不同的电缆长度可根据实际需要, 在订货号的第三部分自行修改, 电缆长度单位: cm

# 工业以太网技术 ETHERNET-TECHNOLOGY

**PROFI**<sup>®</sup> **EtherNet/IP**<sup>™</sup>  
performance tested  
**NET**  
 CAT.5e  
 双端预铸线束  
 屏蔽 Shielded

插针 Male M12  
 直出 Straight



插针 Male RJ45

插针 Male M12  
 90°



<b>1</b>	刺破型号 Form No.	<b>944711</b> (曾用料号: 944911)	<b>944761</b>
	包胶型号 Form	944711Y (曾用料号: 944911Y)	944761Y
	极数 Suppression	4-pole	4-pole
	刺破型号 Form 板后安装	插孔 Female M12 板后安装	插针 Male RJ45 IDC 刺破型接线
	板后安装		

	刺破型号 Form No.	<b>944733</b> (曾用料号: 944771)	<b>999711</b> (曾用料号: 999611)
	包胶型号 Form	944733Y (曾用料号: 944771Y)	999711Y (曾用料号: 999611Y)
	极数 Suppression	4-pole	4-pole

针脚排序  
 Contact layout

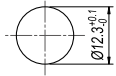

插孔 Female

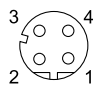

插针 Male



M12 转 RJ45 接线图

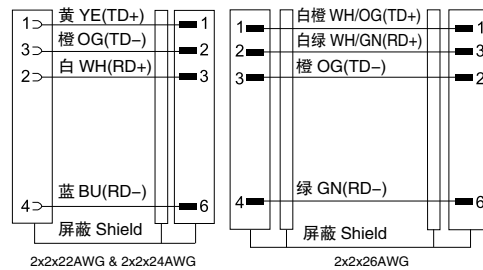

RJ45 转 RJ45 接线图

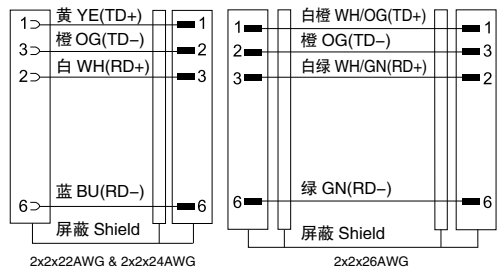

IDC 刺破型结构



选用 24AWG 或 22AWG 线



选用 26AWG 线

包胶结构



都适用

<b>2</b>	电缆类型 Cable type	护套颜色 Jacket color
	Profinet (2x2x22AWG)	绿 GN
	固定安装 Fixed installation TypeA	790
	拖链、抗扭 Highly flexible, torsion TypeC	796
	CAT 5e. (2x2x24AWG)	蓝 BU
	固定安装 Flexible installation PVC	795 782
	拖链安装 Highly flexible PUR	797
	CAT 5e. (2x2x26AWG)	
	固定安装 Flexible installation PVC	791
	拖链安装 Highly flexible PUR	793

<b>3</b>	电缆长度 Cable length
	1.5m 0150
	3.0m 0300
	5.0m 0500
	7.5m 0750
	10.0m 1000

订货号 Part No.

可参考: 6.0.1  
 Reference: 6.0.1

例: 944733 - 790 - 0500

**1** 型号 Form      **2** 电缆类型 Cable type      **3** 电缆长度 Cable length

备注 Notes

电缆参数 Cable parameter: 8.3.2 尺寸参数 Size parameter: 6.0.4 配件页面 Accessories on page: 7.7.5  
 不同的电缆长度可根据实际需要, 在订货号的第三部分自行修改, 电缆长度单位: cm



**EtherNet/IP™**  
*conformance tested*

Ethernet 300M -1 Gbps

CAT.5e

 双端预铸线束  
 Connection cable

屏蔽 Shielded

 插针 Male M12  
 直出 Straight

 插针 Male RJ45  
 直出 Straight

 插针 Male RJ45  
 直出 Straight

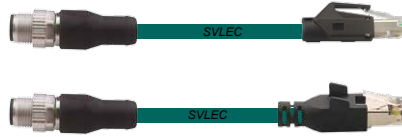
 插针 Male RJ45  
 直出 Straight

包胶结构

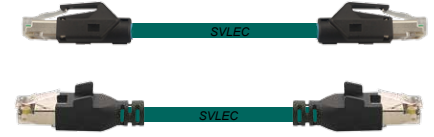

包胶结构

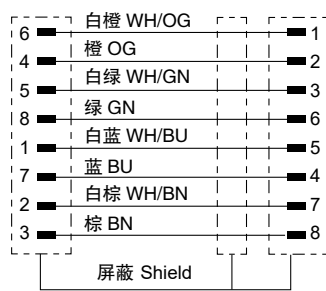
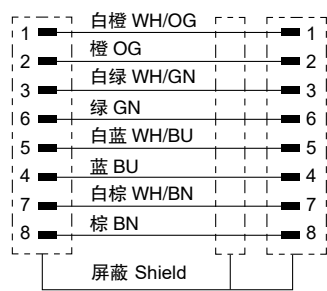
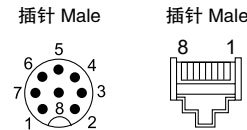
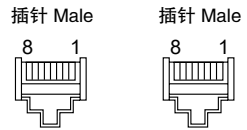
1	型号 Form	No.	944811	999811			
	包胶型号		944811Y	999811Y			
	极数 Suppression		8-pole	8-pole			
	电路图 Circuit diagram						
	针脚排序 Contact layout						
2	电缆类型 Cable type	护套颜色 Jacket color	蓝 BU				
	CAT 5e. 4x2x26AWG		792				
	固定安装 Flexible installation PVC		799				
	拖链安装 Highly flexible PUR						
3	电缆长度 Cable length						
	1.5m		0150				
	3.0m		0300				
	5.0m		0500				
	7.5m		0750				
	10.0m		1000				
	订货号 Part No.						
	可参考: 6.0.1 Reference: 6.0.1	例:	944811	792	0500		
		1	型号 Form	2	电缆类型 Cable type	3	电缆长度 Cable length
	备注 Notes		电缆参数 Cable parameter: 8.3.2 尺寸参数 Size parameter: 6.0.4 配件页面 Accessories on page: 7.7.5 不同的电缆长度可根据实际需要, 在订货号的第三部分自行修改, 电缆长度单位: cm				

# M12 圆形连接器 ROUND PLUG CONNECTOR

M12 X-code

CAT 6<sub>A</sub> 标准

实现 10 Gdps 传输速率

冷压接 Crimp terminal

屏蔽 Shielded

插针 Male

直出 Straight

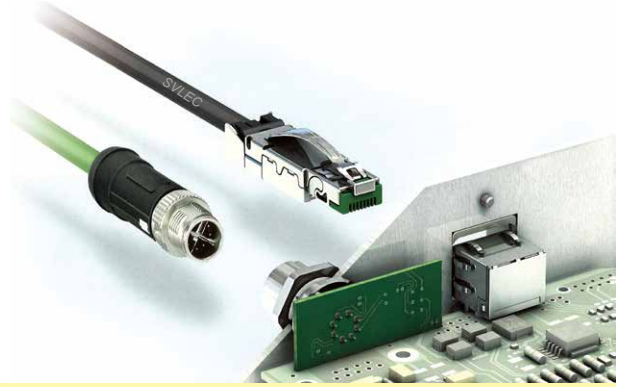

<b>1</b>	<b>型号 Form</b>	<b>No. 917941</b>																																
极数 Suppression	8-pole																																	
电路图 Circuit diagram	<table border="1" style="width: 100%; border-collapse: collapse;"> <tr><td style="width: 10px;">1</td><td style="width: 10px;">■</td><td>白 / 橙 WH/OG</td><td style="width: 10px;">○</td></tr> <tr><td>2</td><td>■</td><td>橙 OG</td><td>○</td></tr> <tr><td>3</td><td>■</td><td>白 / 绿 WH/GN</td><td>○</td></tr> <tr><td>4</td><td>■</td><td>绿 GN</td><td>○</td></tr> <tr><td>5</td><td>■</td><td>白 / 棕 WH/BN</td><td>○</td></tr> <tr><td>6</td><td>■</td><td>棕 BN</td><td>○</td></tr> <tr><td>7</td><td>■</td><td>白 / 蓝 WH/BU</td><td>○</td></tr> <tr><td>8</td><td>■</td><td>蓝 BU</td><td>○</td></tr> </table>		1	■	白 / 橙 WH/OG	○	2	■	橙 OG	○	3	■	白 / 绿 WH/GN	○	4	■	绿 GN	○	5	■	白 / 棕 WH/BN	○	6	■	棕 BN	○	7	■	白 / 蓝 WH/BU	○	8	■	蓝 BU	○
1	■	白 / 橙 WH/OG	○																															
2	■	橙 OG	○																															
3	■	白 / 绿 WH/GN	○																															
4	■	绿 GN	○																															
5	■	白 / 棕 WH/BN	○																															
6	■	棕 BN	○																															
7	■	白 / 蓝 WH/BU	○																															
8	■	蓝 BU	○																															
针脚排序 Contact layout	<p style="text-align: center;">插针 Male</p>																																	
<b>2</b>	<b>技术参数 Technical data</b>																																	
额定电压 Supply voltage	50 V AC/DC																																	
额定电流 Current per contact (40°C)	max. 0.5 A																																	
压线范围 Connection diameter	最大 max. 0.75 mm <sup>2</sup>																																	
外壳材料 Housing material	铜锌合金，表面镀镍 CuZn, nickel plated																																	
压线方式 Wiring method	冷压接 Crimp terminal																																	
防护等级 Protection	IP67 – 插孔插针配合拧紧 ( EN 60529 ) When plugged and screwed down																																	
温度范围 Temperature range	-25...+85°C																																	
<b>订货号 Part No.</b>	<div style="border: 1px solid black; padding: 5px; text-align: center;">             _____ - _____ - _____           </div>																																	
	<b>1</b>	<b>型号 Form</b>																																
备注 Notes																																		

# M12 圆形连接器 ROUND PLUG CONNECTOR



M12 X-code  
 CAT 6<sub>A</sub> 标准  
 实现 10 Gdps 传输速率  
 板面 PCB  
 屏蔽 Shielded

插孔 Female  
 直出 Straight  
 板面



插孔 Female  
 90°

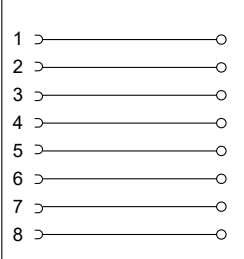
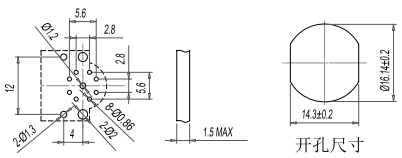

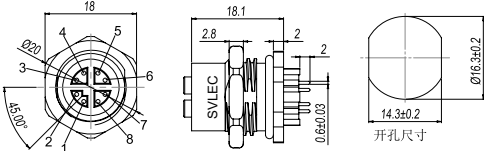
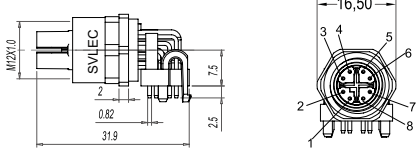
<b>1</b>	<b>型号 Form</b>	<b>No.</b>	<b>912801</b>	<b>914804</b>
	极数 Suppression		8-pole	8-pole
	电路图 Circuit diagram			
	针脚排序 Contact layout		<p style="text-align: center;">插孔 Female</p> 	<p style="text-align: center;">插孔 Female</p> 
<b>2</b>	<b>技术参数 Technical data</b>			
	额定电压 Supply voltage	50 V AC/DC		
	额定电流 Current per contact	max. 0.5 A		
	防护等级 Protection	IP67 – 插孔插针配合拧紧 ( EN 60529 ) When plugged and screwed down		
	温度范围 Temperature range	-25...+85°C		
	尺寸图 Description			
				
	<b>订货号 Part No.</b>	<div style="text-align: center;"> <span style="font-size: 2em;">-</span> <span style="font-size: 2em;">-</span> <span style="font-size: 2em;">-</span> <span style="font-size: 2em;">-</span> <span style="font-size: 2em;">-</span> <span style="font-size: 2em;">-</span> <span style="font-size: 2em;">-</span> <span style="font-size: 2em;">-</span> </div>		
		<b>1</b>	<b>型号 Form</b>	
	备注 Notes			

X-Code 现场总线

# M12 圆形连接器 ROUND PLUG CONNECTOR

M12 X-code  
 CAT 6<sub>A</sub> 标准  
 实现 10 Gdps 传输速率  
 焊接线缆  
 屏蔽 Shielded

插孔 Female  
 直出 Straight  
 板面



<b>1</b>	<b>型号 Form</b>	<b>No.</b>	<b>912082</b>
	极数 Suppression		8-pole
	电路图 Circuit diagram		
	针脚排序 Contact layout		<p style="text-align: center;">插孔 Female</p>
<b>2</b>	<b>技术参数 Technical data</b>		
	额定电压 Supply voltage		50 V AC/DC
	额定电流 Current per contact		max. 0.5 A
	防护等级 Protection		IP67 – 插孔插针配合拧紧 ( EN 60529 ) When plugged and screwed down
	温度范围 Temperature range		-25...+85°C
	尺寸图 Description		
	<b>订货号 Part No.</b>		
	<b>1 型号 Form</b>		
	备注 Notes		

X-Code 现场总线

# M12 圆形连接器 ROUND PLUG CONNECTOR

POE CAT.6<sub>A</sub>  
 X-code to M12  
 CAT 6<sub>A</sub> 标准  
 实现 10 Gdps 传输速率  
 屏蔽 Shielded

插针 Male M12  
 直出 Straight



插针 Male M12  
 直出 Straight

插针 Male M12  
 直出 Straight

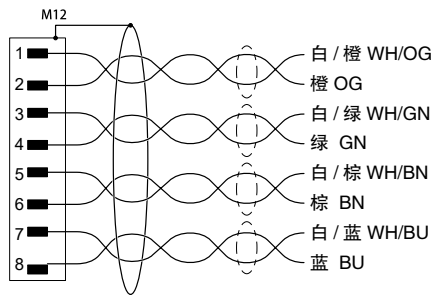
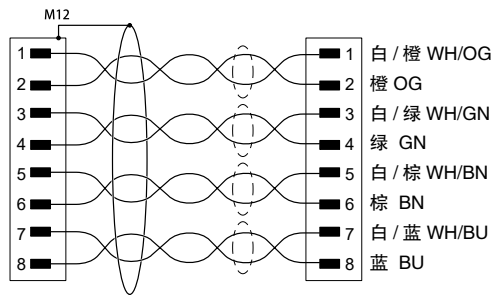
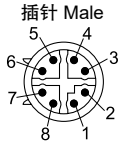
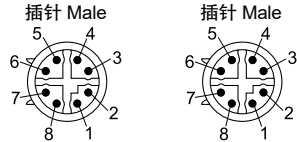
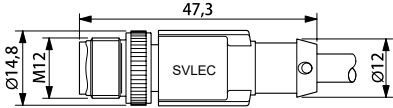

<b>1</b>	<b>型号 Form</b>	<b>No.</b>	<b>917484</b>	<b>917485</b>
	<b>极数</b> Suppression		8-pole	8-pole
	<b>电路图</b> Circuit diagram			
	<b>针脚排序</b> Contact layout			
<b>2</b>	<b>电缆类型 Cable type</b>	<b>护套颜色 Jacket color</b>	CAT 6 <sub>A</sub> . 4x(2x26AWG) <span style="background-color: #008000; color: white; padding: 2px;">绿 GN</span> 移动安装 Flexible installation <span style="background-color: #008000; color: white; padding: 2px;">789</span>	
				
<b>3</b>	<b>电缆长度 Cable length</b>		1.5m 0150 3.0m 0300 5.0m 0500 7.5m 0750 10.0m 1000	
	<b>技术数据 Technical data</b>		工作电压 Supply voltage 30 V AC/DC 防护等级 Protection 插好并拧紧后 When plugged and screwed down IP67 (EN60529) 温度范围 Temperature range -25...+85°C , 取决于电缆质量	
	<b>订货号 Part No.</b>		例: <u>    917484    </u> - <u>    789    </u> - <u>    0500    </u>	
	可参考: 6.0.1 Reference: 6.0.1		<b>1</b> 型号 Form <b>2</b> 电缆类型 Cable type <b>3</b> 电缆长度 Cable length	
	<b>备注 Notes</b>		电缆参数 Cable parameter: 8.3.2 尺寸参数 Size parameter: 6.0.4 配件页面 Accessories on page: 7.7.5 不同的电缆长度可根据实际需要, 在订货号的第三部分自行修改, 电缆长度单位: cm	

# 工业以太网技术 ETHERNET-TECHNOLOGY

**EtherNet/IP™**  
conformance tested

Ethernet 10 Gbps

CAT.6<sub>A</sub>

双端预铸线束  
Connection cable

屏蔽 Shielded

插针 Male M12  
直出 Straight

插针 Male RJ45  
压接式接线

插针 Male RJ45  
直出 Straight

插针 Male RJ45  
直出 Straight



<b>1</b>	<b>型号 Form No.</b>	<b>948811</b>	<b>999851</b>
	<b>极数 Suppression</b>	8-pole	8-pole
	<b>电路图 Circuit diagram</b>		
	<b>针脚排序 Contact layout</b>		
<b>2</b>	<b>电缆类型 Cable type</b>	<b>护套颜色 Jacket color</b>	
	CAT 6 <sub>A</sub> , 4x(2x26AWG)	绿 GN	
	移动安装 Flexible installation	789	
<b>3</b>	<b>电缆长度 Cable length</b>		
	1.5m	0150	
	3.0m	0300	
	5.0m	0500	
	7.5m	0750	
	10.0m	1000	
	<b>技术数据 Technical data</b>		
	工作电压 Supply voltage	30 V AC/DC	
	防护等级 Protection	插好并拧紧后 IP67 (M12) – IP20 (RJ45) When plugged and screwed down (EN60529)	
	温度范围 Temperature range	-25...+85°C , 取决于电缆质量	
	<b>订货号 Part No.</b>		
	可参考: 6.0.1 Reference: 6.0.1	例: <u>    948811    </u> – <u>    789    </u> – <u>    0500    </u>	
		<b>1</b> 型号 Form	<b>2</b> 电缆类型 Cable type
			<b>3</b> 电缆长度 Cable length
	<b>备注 Notes</b>	电缆参数 Cable parameter: 8.3.2 尺寸参数 Size parameter: 6.0.4 配件页面 Accessories on page: 7.7.5 不同的电缆长度可根据实际需要, 在订货号的第三部分自行修改, 电缆长度单位: cm	

X-Code 现场总线

## CC-Link

M12 单端预铸线束  
With open ended wires M12



屏蔽 A-Code  
Shielded, A-code

插针 Male  
直出 Straight



插孔 Female  
直出 Straight

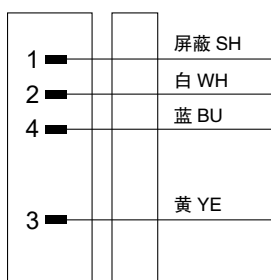
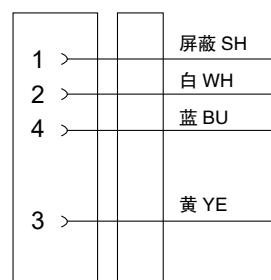
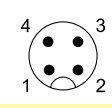
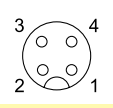

1	型号 Form	No.	947011	947021			
	极数 Suppression	4-pole		4-pole			
		插针 Male 90°		插孔 Female 90° 			
	型号 Form	No.	947311	947321			
	极数 Suppression	4-pole		4-pole			
	电路图 Circuit diagram						
	针脚排序 Contact layout	插针 Male 		插孔 Female 			
2	电缆类型 Cable type	护套颜色 Jacket color					
	导体横截面 CSA 3x0.5mm <sup>2</sup> PVC 固定安装 Fixed installation	红 RD 760	红 RD 760				
3	电缆长度 Cable length						
	1.5m	0150					
	3.0m	0300					
	5.0m	0500					
	7.5m	0750					
	10.0m	1000					
订货号 Part No.							
可参考: 6.0.1 Reference: 6.0.1		例: <u>    947011    </u> - <u>    760    </u> - <u>    0500    </u>					
		1	型号 Form	2	电缆类型 Cable type	3	电缆长度 Cable length
备注 Notes		电缆参数 Cable parameter: 8.3.2 尺寸参数 Size parameter: 6.0.4 配件页面 Accessories on page: 7.7.5 不同的电缆长度可根据实际需要, 在订货号的第三部分自行修改, 电缆长度单位: cm					

# 现场总线连接器 PLUG CONNECTORS FOR FIELDBUS TECHNOLOGY

**CC-Link**

M12 单端预铸线束  
With open ended wires M12

屏蔽 A-Code  
Shielded, A-code

插针 Male  
直出 Straight

插孔 Female  
直出 Straight

插针 Male  
90°

插孔 Female  
90°



<b>1</b>	<b>型号 Form</b>	<b>No.</b>	<b>987021</b>	<b>987321</b>										
	<b>极数</b> Suppression		4-pole	4-pole										
	<b>电路图</b> Circuit diagram													
	<b>针脚排序</b> Contact layout													
<b>2</b>	<b>电缆类型 Cable type</b>	<b>护套颜色 Jacket color</b>	<table border="1"> <tr> <td>导体横截面 CSA 3x0.5mm<sup>2</sup></td> <td>红 RD</td> </tr> <tr> <td>PVC 固定安装 Fixed installation</td> <td>760</td> </tr> </table>		导体横截面 CSA 3x0.5mm <sup>2</sup>	红 RD	PVC 固定安装 Fixed installation	760						
导体横截面 CSA 3x0.5mm <sup>2</sup>	红 RD													
PVC 固定安装 Fixed installation	760													
<b>3</b>	<b>电缆长度 Cable length</b>		<table border="1"> <tr> <td>0.3m</td> <td>0030</td> </tr> <tr> <td>0.6m</td> <td>0060</td> </tr> <tr> <td>1.0m</td> <td>0100</td> </tr> <tr> <td>1.5m</td> <td>0150</td> </tr> <tr> <td>2.0m</td> <td>0200</td> </tr> </table>		0.3m	0030	0.6m	0060	1.0m	0100	1.5m	0150	2.0m	0200
0.3m	0030													
0.6m	0060													
1.0m	0100													
1.5m	0150													
2.0m	0200													
	<b>订货号 Part No.</b>		<table border="1"> <tr> <td>可参考: 6.0.1 Reference: 6.0.1</td> <td>例: <u>  987021  </u> - <u>  760  </u> - <u>  0500  </u></td> </tr> </table>		可参考: 6.0.1 Reference: 6.0.1	例: <u>  987021  </u> - <u>  760  </u> - <u>  0500  </u>								
可参考: 6.0.1 Reference: 6.0.1	例: <u>  987021  </u> - <u>  760  </u> - <u>  0500  </u>													
		<b>1</b>	<b>型号 Form</b>	<b>2</b>	<b>电缆类型 Cable type</b>	<b>3</b>	<b>电缆长度 Cable length</b>							
	<b>备注 Notes</b>	电缆参数 Cable parameter: 8.3.2 尺寸参数 Size parameter: 6.0.4 配件页面 Accessories on page: 7.7.5 不同的电缆长度可根据实际需要, 在订货号的第三部分自行修改, 电缆长度单位: cm												

CC-Link 现场总线



# AS-i Passive Distributor 物流方案

刺破  
Insulation penetration  
technology

插孔 Female  
直出 Straight

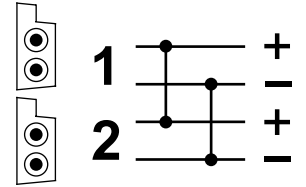

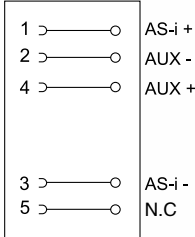
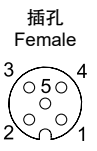
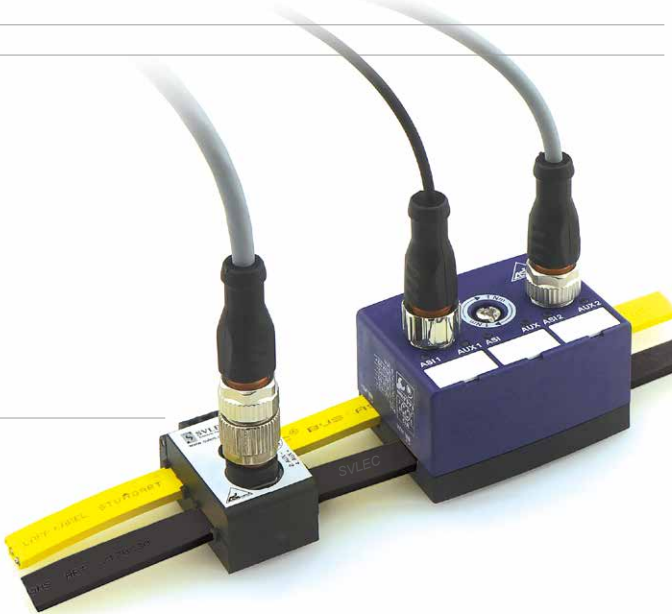
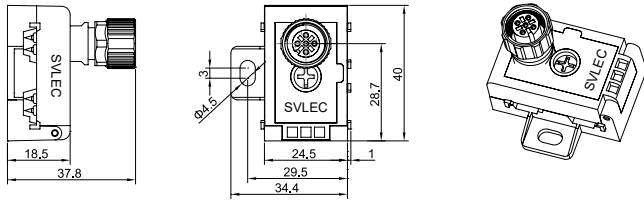
<b>1</b>	<b>型号 Form</b>	<b>No. 912909</b>
	极数 Suppression	5-pole
	电路图 Circuit diagram	
	针脚排序 Contact layout	<p>插孔 Female</p> 
<b>2</b>	<b>技术参数 Technical data</b>	
	额定电压 Supply voltage	10 ... 32 V <sub>DC</sub> PELV
	额定电流 Current per contact (40°C)	max. ≤ 4 A
	外壳材料 Housing material	阻燃塑料 Flame retardant plastic
	压线方式 Wiring method	刺破 Insulation penetration technology
	防护等级 Protection	IP67- 插孔插针配合拧紧 ( EN 60529 ) When plugged and screwed down
	温度范围 Temperature range	-30 ... 70 °C
	尺寸图 Description	
	订货号 Part No.	<p>----- - ----- - -----</p>
	<b>1</b>	<b>型号 Form</b>
	备注 Notes	

# AS-Interface 物流方案

AS-i 渗透技术

插孔 Female  
直出 Straight



插孔 Female  
90°



<b>1</b>	<b>型号 Form</b>	<b>No.</b>	<b>912968</b>	<b>912969</b>
	<b>极数</b> Suppression		2-pole	4-pole
	<b>电路图</b> Circuit diagram			
	<b>针脚排序</b> Contact layout		<p>插孔 Female</p>	<p>插孔 Female</p>
<b>2</b>	<b>电缆类型 Cable type</b>	<b>护套颜色 Jacket color</b>		
	导体横截面 CSA 0.34mm <sup>2</sup>	黑 BK	黑 BK	
	PUR	623	624	
<b>3</b>	<b>电缆长度 Cable length</b>			
	0.3m	0030		
	0.6m	0060		
	1.0m	0100		
	1.5m	0150		
	2.0m	0200		
	<b>尺寸图 Description</b>	<p>安装孔的距离和位置 04.2</p>		
	<b>订货号 Part No.</b>			
	例:	<u>  912959  </u>	<u>  623  </u>	<u>  0500  </u>
	<b>1</b>	<b>型号 Form</b>	<b>2</b>	<b>电缆类型 Cable type</b>
	<b>3</b>	<b>电缆长度 Cable length</b>		
	<b>备注 Notes</b>			

AS-i 物流方案

# AS-i Passive Distributor 物流方案

产品类型	电缆接口类型 Profile cable connection	接口 Connection	订货号 Part No.
ASi/AUX 无源分线器 	ASi/AUX 转 2 x M12, 带保护电路 1 x A Si, 1 x AUX 1 x ASi, 1 x AUX 	4 A, changeable, 2 x M12 sockets, 5-poles 1 A, self-resetting, 2 x M12 sockets, 5-poles	912929 912939
ASi 无源分线器 	ASi/AUX 一分二路 2 x ASi 	profile cable branch	913157
ASi 无源分线器 量多可订做 	ASi/AUX 转预铸线, 带保护电路 1 x ASi, 1 x AUX 	1 A, self-resetting, 4-poles	912959
AS-i IO 模块 量多可订做 	AS-i IO 模块 4 x DI, 4 x DO 	1 A, self-resetting, 6-poles	912960
扁平电缆 (黄色) 	黄色扁平电缆, 2x1.5 mm <sup>2</sup> PUR (UL/CSA), C-tracks		783
扁平电缆 (黑色) 	黑色扁平电缆, 2x1.5 mm <sup>2</sup> PUR (UL/CSA), C-tracks		786

# AS-i 物流方案

-M8 B-Code

插针 Male  
直出 Straight



底孔 Female  
直出 Straight



插针  
直出



底孔  
直出

底座 Female  
直出 Straight



1	型号 Form No.	908151	908051	988101	908532
	食品和饮料 FOOD & BEVERAGE				
	极数 Suppression	5-pole	5-pole	5-pole	5-pole
	电路图 Circuit diagram				
	针脚排序 Contact layout				
2	电缆类型 Cable type	护套颜色 Jacket color			
	导体横截面 3x0.14+2x0.34mm <sup>2</sup>	黑 BK			
	PVC	612			
3	电缆长度 Cable length				
	1.5m	0150			
	3.0m	0300			
	5.0m	0500			
	7.5m	0750			
	10.0m	1000			
	订货号 Part No.				
	可参考: 6.0.1 Reference: 6.0.1	例: <u>  908151  </u> - <u>  612  </u> - <u>  0500  </u>			
		1 型号 Form	2 电缆类型 Cable type	3 电缆长度 Cable length	
	备注 Notes				
		电缆参数 Cable parameter: 8.3.2 尺寸参数 Size parameter: 6.0.4 配件页面 Accessories on page: 7.7.5 不同的电缆长度可根据实际需要, 在订货号的第三部分自行修改, 电缆长度单位: cm			



AS-i 物流方案



# 现场总线 DEVICENET, CANOPEN

描述 Describe	M12 插针 A-code		M12 插孔 A-code		M12 插针屏蔽		M12 插孔屏蔽		M12 插针屏蔽		M12 插孔屏蔽	
												
极数 Suppression	CC-Link 4-pin	Devicenet 5-pin	CC-Link 4-pin	Devicenet 5-pin	Profibus B-Code 5-pin	以太网 /Profinet D-Code 4-pin	Profibus B-Code 5-pin	以太网 /Profinet D-Code 4-pin	Profibus B-Code 5-pin	以太网 /Profinet D-Code 4-pin	Profibus B-Code 5-pin	以太网 /Profinet D-Code 4-pin
订货号: Part No.	912741	912761	912941	912961	914001	914521	914021	914621	914011	914581	914031	914661







描述 Describe	M12 插针 A-coded	M12 插孔 A-coded	7/8" 插针	7/8" 插孔	7/8" 插针	7/8" 插孔
						
极数 Suppression	5-pin Devicenet		5-pin Devicenet		5-pin Devicenet	
订货号: Part No.	912881		913041		978081	

描述 Describe	RJ45 公插屏蔽, 以太网, 压接式		RJ45 公插屏蔽, 以太网, 可现场装配		RJ45 公插屏蔽, CAT 5e, 可现场装配		RJ45 公插屏蔽, CAT 5e, 可现场装配	
								
极数 Suppression	8-pin IP20		4-pin IP20		8-pin IP20		4-pin IP20	
订货号: Part No.	999041		999051		999181		999061	

描述 Describe	M12 插针, 法兰固定, 屏蔽			M12 插孔, 法兰固定, 屏蔽		
						
极数 Suppression	Devicenet A-Code 5 pin	Profibus B-Code 5 pin	以太网 /Profinet D-Code 4 pin	Devicenet A-Code 5 pin	Profibus B-Code 5 pin	以太网 /Profinet D-Code 4 pin
板后订货号: Part No.	913521-803-xxxx	913522-840-xxxx	914501-790-xxxx	913561-803-xxxx	913562-840-xxxx	913503-790-xxxx
板前订货号: Part No.	913524-803-xxxx	914121-840-xxxx	913506-790-xxxx	913564-803-xxxx	914164-840-xxxx	914501-790-xxxx

描述 Describe	M12 插针			M12 终端电阻			7/8" 终端电阻
							
极数 Suppression	Devicenet A-Code 5 pin	Profibus B-Code 5 pin	以太网 Profine D-Code 4 pin	CC-Link A-Code 4 pin	Devicenet A-Code 5 pin	Profibus B-Code 5 pin	Devicenet 5-pin
订货号: Part No.	942111	944111	949111	947001	913461	914041	978301

描述 Describe	M12 插针转 RJ45 适配器屏蔽	M12 插孔转 RJ45 适配器屏蔽	M12 插孔转 RJ45 适配器屏蔽	M12-2M12 T 型屏蔽	M12-2M12 T 型	7/8" - M12 T 型
						
极数 Suppression	CAT 5e D-Code 4 pin	CAT 5e D-Code 4 pin	CAT 5e D-Code 4 pin	B-Code 5 pin Profibus	A-Code 5 pin Profibus	T-Code 5 pin Profibus
订货号: Part No.	9450120001	9450120002	9450120003	941061	940061	943061

描述 Describe	RJ45 底座	RJ45 插头	出线 90° 带编程口	出线 90°	出线 45° 带编程口	出线 90°
						
极数 Suppression	A-Code 5 pin Devicenet	A-Code 5 pin Devicenet	Profibus D-SUB-D9	Profibus D-SUB-D9	Profibus D-SUB-D9	Profibus D-SUB-D9
订货号: Part No.	950061	950081	955761	955762	955751	955752

现场总线附件

# 现场总线连接器 PLUG CONNECTOR FOR FIELDBUS TECHNOLOGY

		订货号 Part No.			订货号 Part No.
	Profibus			Profibus	
	1 x 2 x Ø0.64 mm 紫色 Violet 适用于固定安装 Fixed installation	840		1 x 2 x Ø0.64 mm 紫色 Violet 适用于拖链 Suitable for C-tracks	841
	DeviceNet, CANopen			DeviceNet, CANopen	
	2 x 23AWG + 2 x 22AWG 紫色 Violet, 细缆 Cable Thin 适用于拖链、抗扭 Highly flexible, Torsion	803		2 x 23AWG + 2 x 22AWG 紫色 Violet, 细缆 Cable Thin 适用于固定安装 Fixed installation	807
	DeviceNet, CANopen			CC-Link	
	2 x 18AWG + 2 x 15AWG 灰色 Gray, 粗缆 Cable Thick 适用于固定安装 Fixed installation	809		3 x 20AWG 红色 Red 适用于固定安装 Fixed installation	760
	Profinet			Profinet	
	2 x 2 x 22AWG1 绿色 Green 适用于固定安装 Fixed installation Type A	790		2 x 2 x 22AWG7 绿色 Green 适用于拖链、抗扭 Highly flexible, torsion Type C	796
	EtherNet CAT.6			EtherNet CAT.5e	
	4 x 2 x 26AWG 绿色 Green 适用于移动安装 Flexible installation	789		绿色 Green 2 x 2 x 24AWG7 适用于移动安装 Flexible installation 2 x 2 x 24AWG19 适用于拖链安装 Highly flexible	795
	EtherNet CAT.5e			EtherNet CAT.5e	
	蓝色 Blue 2 x 2 x 26AWG7 适用于移动安装 Flexible installation 2 x 2 x 26AWG19 适用于拖链安装 Highly flexible	791 793		蓝色 Blue 4 x 2 x 26AWG7 适用于移动安装 Flexible installation 4 x 2 x 26AWG19 适用于拖链安装 Highly flexible	792 799

现场总线电缆参数