

Product Manual

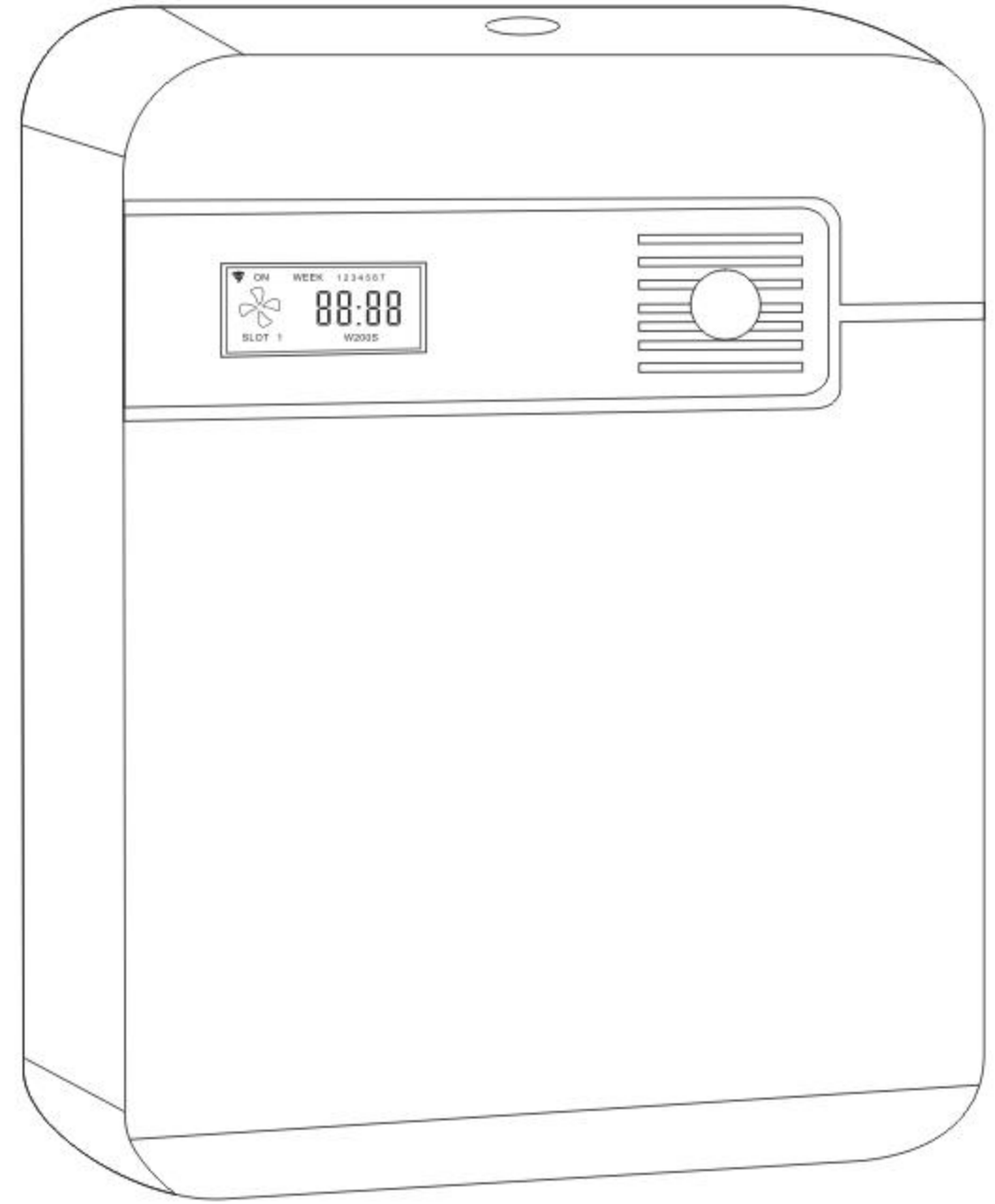

App download



APP icon:



Notice: IOS users search IOT on the Apple Store to download.

Android users scan the QR code to download

Tips

 Press [MODE] key 10 seconds, WIFI prompt icon displays and flashes continuously, it always displays after connecting (if not disconnected), no displays after WIFI disconnection (version without WIFI no icon).

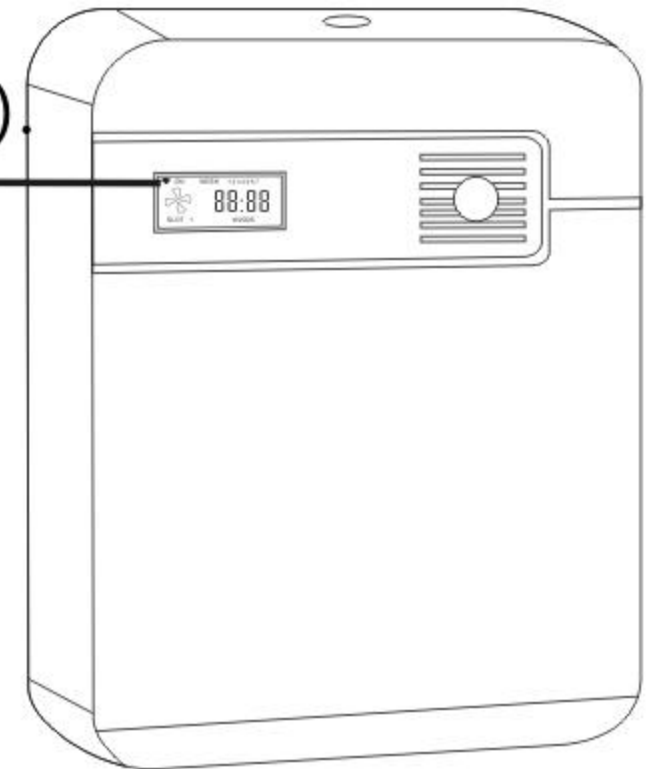

Atomization level and working parameters

Working time /single times (s)	10s-200s (adjustable)
Interval time/single time (s)	10s-200s (adjustable)

Instruction

First step: Press device [MODE] key 10 seconds for distribution network mode.

1, Press device [MODE] key 10 seconds

2, WIFI prompt icon display and flash continuously

3, Time slot display

4, Date display

5, Working time (atomizing time)

MODE SET UP DOWN

APP operation demonstration: Add device

The first screenshot shows the login screen with fields for phone number (+86) and password, a 'Log In' button, and links for 'Register account' and 'Forget password'. The second screenshot shows the main app interface with a search bar, 'Add Device' button, and a list of devices. The third screenshot shows the 'Add a smart fragrance system' screen with instructions: '1. Turn on the mobile phone, connect the signal with good signal, non-5G, non-Chinese name Wi-Fi' and '2. Connect the device to the power supply, press and hold the switch until the indicator light flashes quickly.' It includes a 'Next' button and a radio button option 'Make sure the above steps are completed'.

Notice: new user downloads the app first, use mobile number to register, then sign in

The left screenshot shows a device card for 'Front extension equipment' with a 'Liquid' level indicator at 100% and an 'Authorize' button. Labels point to the 'Networked device icon (display)' and 'Essential oil remaining'. A note says 'Click the icon, the liquid level, network status, on/off can be controlled' and 'green colors means its on, grey means off'. The right screenshot shows the 'WiFi Config' screen with fields for 'Wi-Fi Name' and 'Wi-Fi Password', a 'WIFI Config' button, and the instruction 'Choose 2.4G not 5G WiFi network to connect'.

Notice: when configuring the WiFi network, ensure the WIFI signal is very strong, it is best to configure the network near the router. If configure the network failed, recommend to try again

APP operation demonstration:

Device Authorization

Enter the authorized phone number and authorization time to authorize

Choose sharing time: 1 hour, 12 hours, 1 day, 1 week, 1 month, 3 months, 6 months, 1 year, forever

My authorization

- 30000001 Authorization: 1545151215
- 40000001 Authorization: 1545151652
- 30000001 Authorization: 1545151311

Click "group" to see your authorized equipment, its location and remaining amount of essential oil

Grouping settings

- Modify group name
- Add device
- Remove device
- Batch timing
- Volume authorization
- Batch essential oil setting
- Delete group

Device Control

On/Off, Timers, Level Reset, Instruction

Setting up the switch

Power on state: start up

Setting: Last boot time: 2019-09-20 08:02:05

Device timer

auto-create
Mon.~Sun.
Opening time: 08:00 Closing time: 22:00
Concentration: 10/100

Total 5 working periods can be set

On/Off Timers

Level reset

0%

25% 50% 75% 100%

Reset

Set the oil level manually after filling essential oils each time, then it is calculated automatically

Add device timer

auto-create

Running time(s): 10

Pause time(s): 100

	Opening time	Closing time
Mon.~Sun.	08 00	22 00
Mon.~Sat.	09 01	23 01
Mon.~Fri.	10 02	02
Monday	11 03	03

Set the running time and pause time from 10-200

Level reset

Set the running time and pause time from 10-200

Parameter

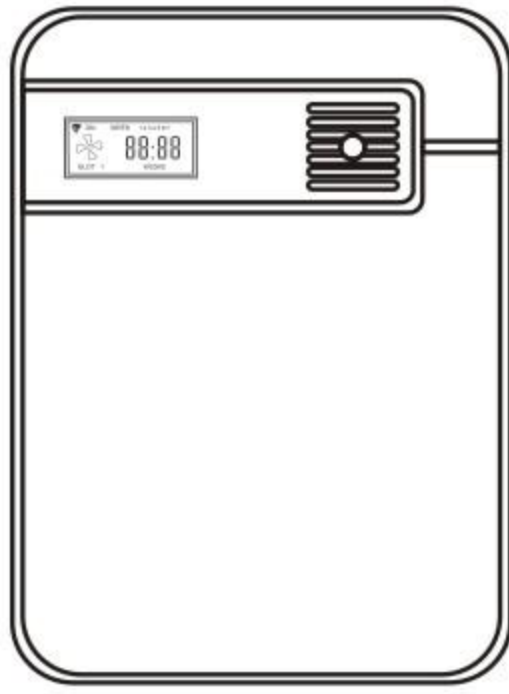

Model No.: 500F
Product Size: 154*70*214mm
Voltage: DC12V
Power: 8W
Coverage: 300-500 m³
Capacity: 200ml
Product weight: 1KG

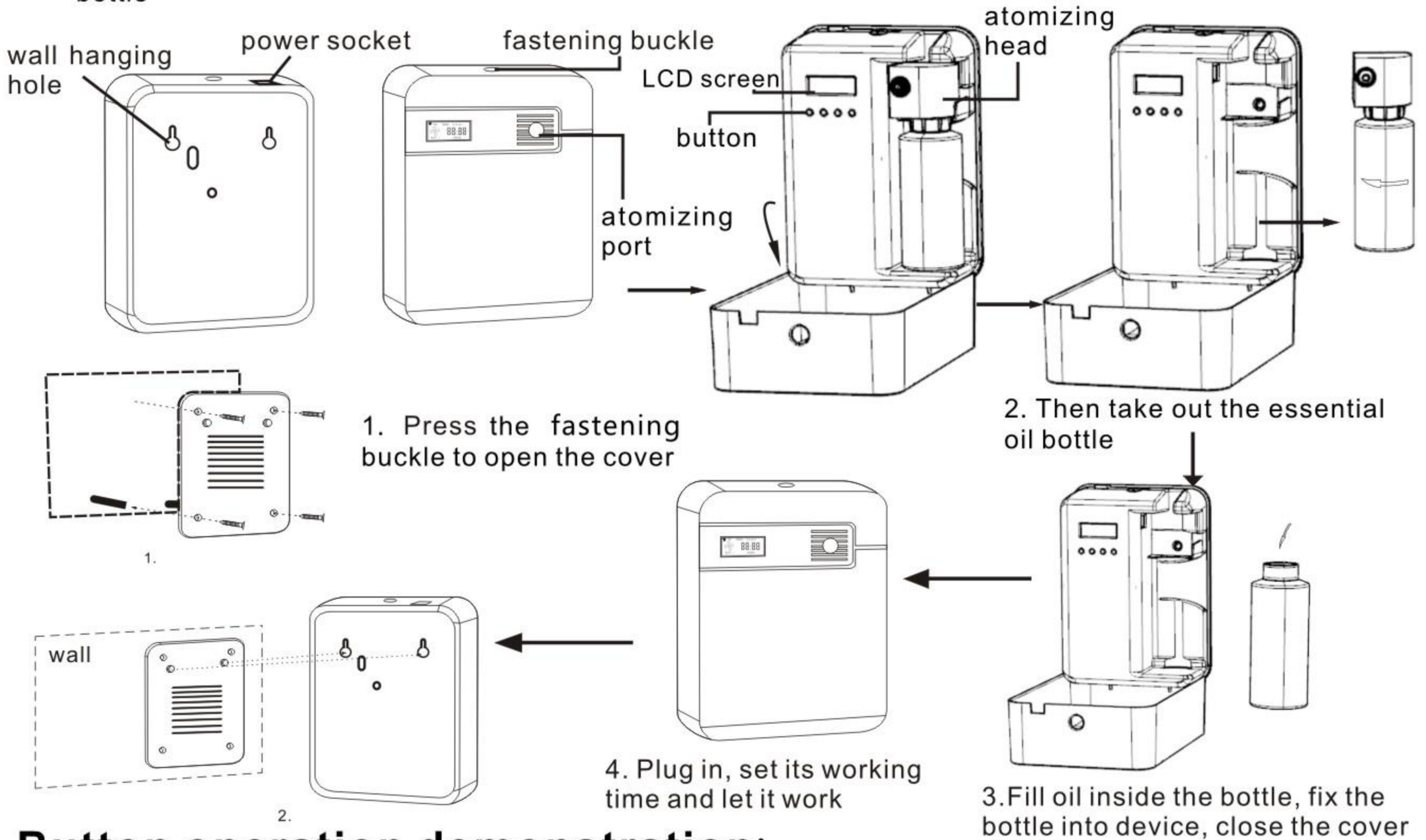
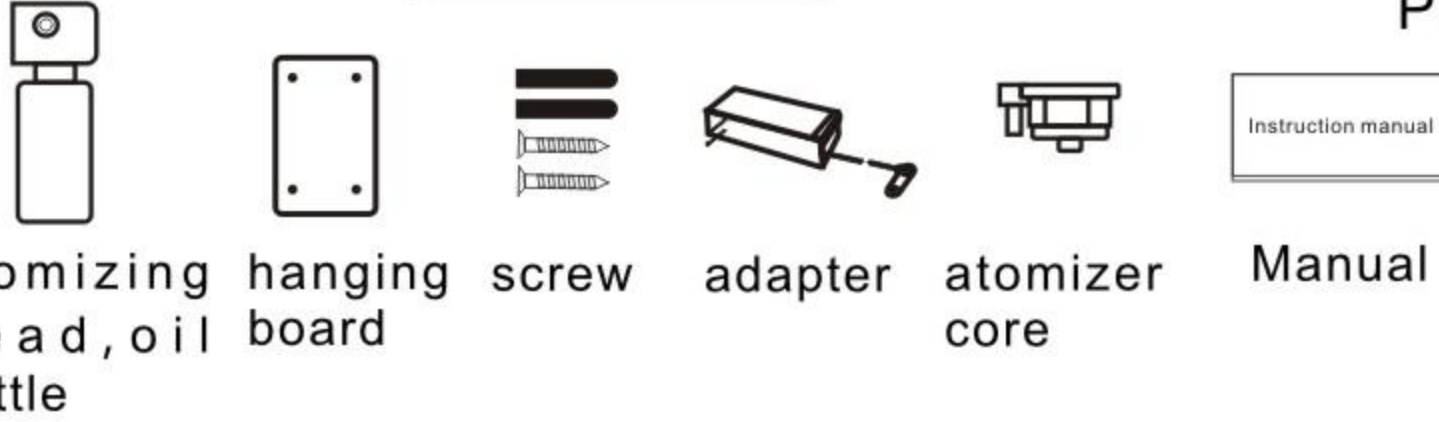

Button operation demonstration:

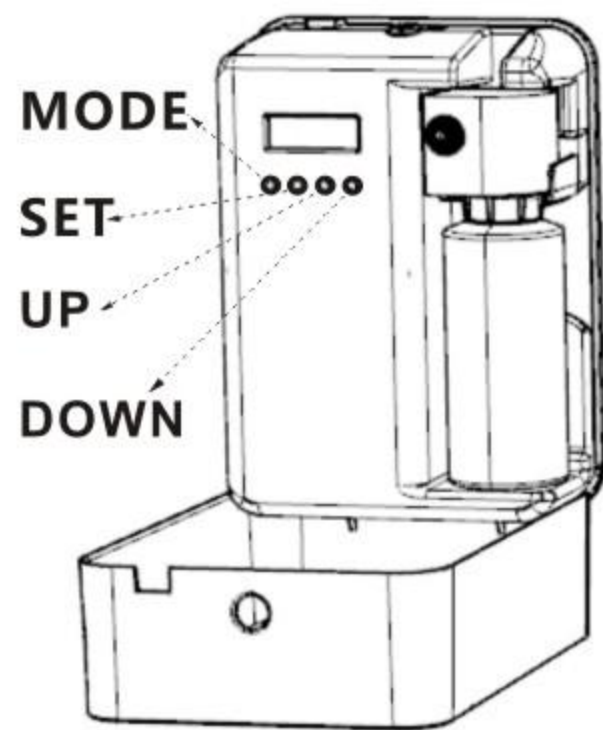

Button function:

[MODE]: long press: 10s for WIFI connecting, short press: enter into timer setting state.

[SET]: long press: control built-in fan start (stop) time (with memory function), short press: enter into timer setting state.

[UP]: long press: test function, air pump and fan run for 15 seconds, short press: timer/time setting "+" function.

[DOWN]: Long press: lock/unlock the device, short press: timer-time setting "-" function.

The device can be set 5 different operating time periods, and the working day can be selected according to multiple options.

[MODE]: Switch for different options, start and stop time for SLOT 1(the first time period), fragrance intensity. Start and stop time for SLOT 2(the second time period), fragrance intensity. Start and stop time for SLOT 3(the third time period), fragrance intensity. Start and stop time for SLOT 4(the fourth time period), fragrance intensity. Start and stop time for SLOT 5(the fifth time period), fragrance intensity. WIFI version/long press 10s for WIFI network connecting.

[SET]: Enter the selection setting state, choose the setting content of the currently displayed page; including system time, date, intensity, etc.;

[UP]: adjust upwards, you can adjust the time, fragrance intensity, working date.

[DOWN]: adjustment downwards, you can adjust the time, fragrance intensity, working date.

Device button setting working periods instruction

Press the **[MODE]** key for the first time, the LCD screen displays **[SLOT 1 ON]**---start working time for the first time period; press the **[SET]** key to enter the adjustment state; adjust the hour, minute and the working date group by **[UP/DOWN]** key;

Press the **[MODE]** key for the second time, the LCD screen displays **[SLOT 1 OFF]**---the stop time of the first time period; press the **[SET]** key to enter the adjustment state; adjust the hour and minute by **[UP/DOWN]** key;

Press the **[MODE]** key for the third time, the LCD screen displays **[SLOT 1 WEEK]**---continuous working frequency setting. Adjust the working frequency from 10 to 200 by press **[UP/DOWN]** key, each time pressing it changes ± 10 .

Press the **[MODE]** key for the fourth time, the LCD screen displays **[SLOT 1]**-stop working frequency setting, adjust the stop frequency from 10 to 200 seconds by **[UP/DOWN]** key, each time pressing it changes ± 10 .

Press the **[MODE]** key for the fifth time, the LCD screen displays **[SLOT 2 ON]** --- start to working time for the second time period, press the **[SET]** key to enter the adjustment state; adjust the hour, minute, and the working date group by **[UP/DOWN]** key;

To continuous setting, same as the above process. Until 5 time periods are finished.

Notice:

When setting its working time period, the shutdown time cannot precede the start-up time; If the working time period cross 00:00, it needs to be set for two time periods.

Such as the working time is: 21:00-9:00

It should set 2 times period, the first time period is: 21:00-23:59; the second time period is: 00:01-9:00

Set the device system time:

Adjust the display time of the device to be consistent with the actual local time. The system time is 24H.

To show its state, press the **[SET]** key, the hour digits on the LCD screen flash, press **[UP / DOWN]** key to adjust the hour.

[Date option]: You can choose a combination of working days.

(Monday to Sunday) (Monday to Saturday) (Monday to Friday); (Monday) (Tuesday)

(Wednesday) (Thursday) (Friday) (Saturday) (Sunday);

Monday to Wednesday) (Tuesday to Thursday) (Saturday to Sunday); (Monday, Wednesday and Friday) (Tuesday, Thursday and Saturday)

Warning

1. After installation, please keep the machine vertical. Leaning or Flipping will cause oil leakage and damage the machine.

2. If you are not a technician, you must not modify, disassemble or repair the device. If the device breaks down, please contact our technical staff in time.

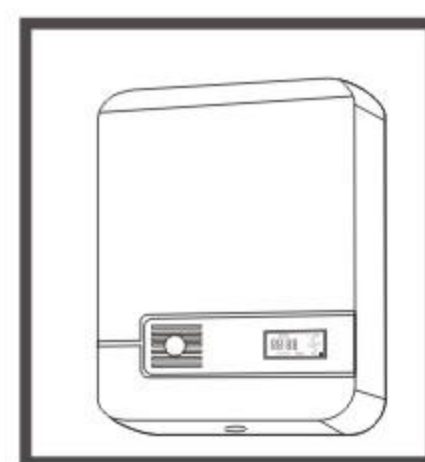
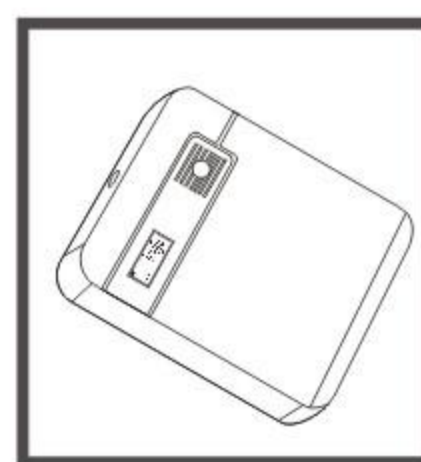

Clean the device

When the following happens, the device needs to be cleaned

1. You are going to change another essential oil to use;
2. The amount of atomizing is getting weaker and weaker;

Cleaning steps

1. Unplug the atomizing nozzle and twist the oil bottle;
2. Pour appropriate amount of alcohol into the oil bottle, install it on the device to work 5-10 times to prevent cross-odor;
3. End the cleaning after drying.

Troubleshooting

Before preparing to repair the machine, first try to solve the problem according to the following methods.

Problem	Solution
No fogging	<ol style="list-style-type: none">1. Check whether the air outlet seal is damaged.2. Check whether the device is in "OFF" state.3. Check whether the air pump is working, or replace the atomizing nozzle.4. Check whether the air pipe connected to the air pump is sealed or damaged.
Small fog	<ol style="list-style-type: none">1. Check whether the air outlet seal is damaged.2. Check whether the atomizing nozzle is blocked.3. Check whether the atomizing nozzle inside is loose, or replace the atomizing nozzle.
Leak oil	<ol style="list-style-type: none">1. Check whether the atomizing nozzle is damaged.2. Check whether the gasket damaged need to replace.3. Check whether the essential oil bottle and the atomizing head are parallel or tighten.
Abnormal noise	<ol style="list-style-type: none">1. Check if the air pump is loose, then fix the air pump again.2. Check whether the air pump is damaged, replace with a new air pump.

After-sales service

- ◆ The equipment is guaranteed within one year from the date of sale, but it does not guarantee the vulnerable parts such as the casing, wires and external pipes, and the damage caused by man-made or accidents is not covered by the warranty. If the warranty period is exceeded, the maintenance will be paid
- ◆ If you encounter any after-sales problems, you can contact the authorized sales service providers in various regions, or contact our sales center directly.