

Opnan® 欧普蓝

宁波轩畅电器有限公司
Ningbo Xuanchang Electric Co.,Ltd.

地址：浙江省慈溪市龙山镇筋竹南路 25 号
Add:No.25 Jinzhu South Road,Longshan Town,Cixi County,Zhejiang Province.

内贸电话：86-574-63736800

外贸电话：86-574-63739585

传真：86-574-63739999 63739585

<http://www.opnan.com>

E-mail:xc@opnan.com

Opnan® 欧普蓝



Direct Drinking Water Purifier

直饮净水机

好水出自欧普蓝 用芯缔造健康

公司简介 Company Profile

宁波轩畅电器有限公司坐落在杭州湾跨海大桥南岸，世界闻名的小家电生产基地—浙江慈溪，是中国最具规模的水处理设备生产企业之一。公司凭借国际领先技术水平，投入巨资从韩国引进水处理生产线、检测系统、近 20 台进口注塑机等设备，建立了轩畅水家电欧普蓝品牌大型生产基地，产品质量和产品成本得到了有效地保障和控制，多年来一直与国内外知名净水企业在技术和贸易上通力合作，产品远销韩国、巴西、日本、东南亚以及欧美等国家。是国内知名净水企业的生产供应商。公司通过了 ISO9001 国际质量管理体系认证、产品获得了国家 3C 安全强制认证、CE 欧盟认证并通过了卫生部门饮水卫生标准审核。

轩畅公司技术研发人员经常与国内外权威专家一起学习、探讨、攻克净水领域新技术，对国内和国外的先进技术、产品设计、质量把控进行了认真的总结和完美的整合，使轩畅水家电产品无论在技术、设计、品质方面做到与众不同在国内净水领域倍受同行们的赏识和尊崇，行业内一致肯定轩畅净水产品“屈指可数、独树一帜”，在市场上深受消费者的青睐，终端市场销量走势甚好，许多经销商纷纷抢先加盟代理。

轩畅公司在 2011 年六月份将在外贸出口的基础上全面启动国内净水市场，让国内的净水技术、饮水质量和产品品质与国际对接，带动和规范国内净水行业进入健康、良性发展的轨道，让中国百姓用上真正品质的净水设备，为消费者提供健康的服务。

我们将继续奉行“品质第一、诚信为本”的经营理念，不断挑战自我，继续维护轩畅公司企业形象，弘扬品牌精神，攀登科技高峰永无止境。

真诚欢迎各界朋友、行业同仁莅临我司参观指导，携手合作，共创辉煌。

NINGBO XUANCHANG ELECTRIC CO.,LTD Located in the world-renown small home appliances town -Cixi,ZhejiangAs the largest scale water treating equipment manufacturer in China,we rely on the internationally leading technological level and invest in a large sum of money to introduce the latest technology production and testing facilities such as direct drinking production line and testing system etc.from korea.we wholeheartedly provide vast consumers with a new and healthy drinking water environment with good quility and good service.

The company has passed ISO9001 quality system certification,product quality,safe and reliable performance.3C products have been mandatory certification and CE certification for European Union,and obtain permisson for Health and the Ministry of Health approval.

Opnan direct drinking water purifier straight through water filtration system,to provide safeth,health,convenience and fashion model of drinking water to human.Many businesses have been approbated at home and abroad on OPNAN's superior product performance,stylish and elegant appearance and enjoy a high reputation in the market.The company based on the business philosophy of openness basing on sincerity.We will serve customers at home and abroad with the best quality,fastest speed, the most favorable price.We will continue to challenge ourselves,Scale the heights enthusiasm for the vast number of users with fist-class products and fist-class service,sincerely hope that friends from all walks of life to guide us,to work together to create brilliant.



合作伙伴 Cooperative Partner



权威认证
Authoritative attestation



中国国家强制性产品认证
证书号: 2018010717044750



CQC 质量管理体系认证
证书号: 00117Q35268R05/3300



涉及饮用水卫生安全产品卫生许可批件
批准文号: 浙(04)卫水字(2018)第0030号

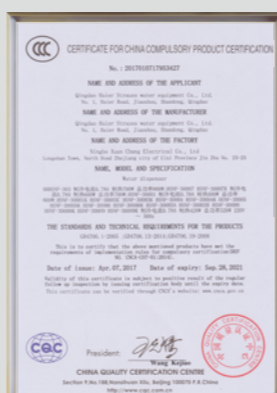
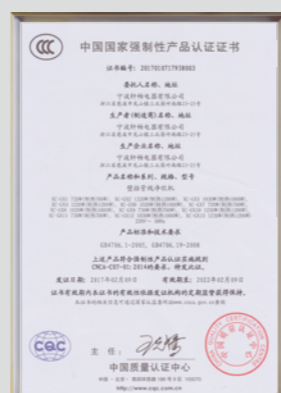

台式免安装即热系列
Desktop installation free instant heating series



采用不锈钢复合式加热体
 95°C速热仅需 2 秒，现喝现烧
 再也不用担心千滚水

Stainless steel composite heater is used
 95°C Fast heat only takes 2 seconds, so you can heat water once you want to drink water
 You don't have to worry about boiling water any more



型号 MODEL

过滤方式 Water purification method	RO 反(渗透过滤) Reverse osmosis	UF(超细微孔过滤) Ultrafiltration
制水速度 Water purification ability	RO 7.8L/h	UF 50L/h
净水箱容量 Pure water tank capacity	1.5L	
原水箱容量 Raw water tank capacity	2L	
热水温度 Hot Water temp	45~95°C	
制热功率 heating power	2000W	
产品尺寸 Size of model	351x197x355mm	



台式免安装茶艺系列 Desktop installation free tea series

尊贵屏显 节能方便
Noble Screen Display Convenient
And Energy-saving

触摸感应设计，只需轻轻触碰即可启动出水电磁阀抛弃传统机械手柄，接水变得更轻松

Touch induction design Only a slight touch can just start "Water Outlet Electro-Magnetic Valve".It abandons the traditional mechanical faucet and gets the water more easily.



型号 MODEL

过滤方式 Water purification method	RO 反(渗透过滤) Reverse osmosis	UF(超细微孔过滤) Ultrafiltration
制水速度 Water purification ability	RO 7.8L/h	UF 50L/h
净水箱容量 Water tank capacity	1.5L	
热水壶容量 Hot water tank capacity	0.8L	
原水箱容量 Raw water tank capacity	2L	
制热功率 heating power	1000W	
热水温度 Hot Water temp	45~95°C	
产品尺寸 Size of model	385x197x355mm	

XC08-09A-WR

DIRECT DRINKING WATER PURIFIER

直饮净水机

抗紫外线材料 UV resistant material

外观材料均作抗紫外线处理，
保证长期使用依旧如新；

All exterior materials are treated with anti
ultraviolet, Ensure long-term use as new as
ever;

超大冷胆 Super large cold tank

超大冷胆，冰水畅饮
多人饮用，清凉消暑

Super large cold tank, drink ice water freely
Provide more cold water for more people

个性定制 Personalized customization

优秀技术团队，提供个性化定制服务，
为您排忧解难

Excellent technical team, providing
customized service, Help you out



型号 MODEL	XC08-09A-WR	
过滤方式 Water purification method	RO 反(渗透过滤) Reverse osmosis	UF(超细微孔过滤) Ultrafiltration
制水速度 Water purification ability	RO 7.8-31.2L/h	UF 50L/h
净水箱容量 Water tank capacity	12L	
热水箱容量 Hot Water tank capacity	3.5-10L	
冷水箱容量 Cold Water tank capacity	5L	
冷水温度 Cold Water temp	4~10°C	
热水温度 Hot Water temp	85~95°C	
制冷器 Cooler	压缩机 Compressor	
产品尺寸 Size of model	380x460x1247mm 或 380x460x1390mm	
包装尺寸 Packing size	530x460x1315mm	
净重 Net weight	RO 33kg	UF 30kg
毛重 Gross weight	RO 36kg	UF 33kg
装柜数量 Container loading qty	40'HQ/220 台	

产品结构图 Product Structure

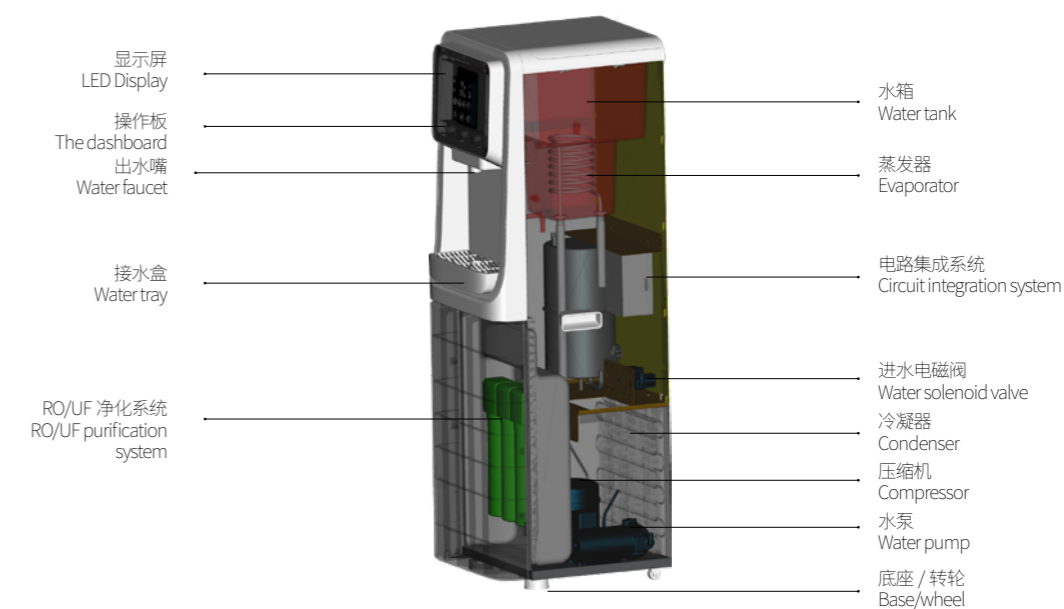

XC08-09B-WR

DIRECT DRINKING WATER PURIFIER

直饮净水机



循环净化 Circulation purification

净水箱 24 小时循环净化，杜绝二次污染；
The clean water tank is purified in a 24-hour cycle, Put an end to secondary pollution;

高精度除菌水嘴 High precision sterilizing nozzle

高精度除菌水嘴设计，解决实用过程的细菌超标
High precision water nozzle design for bacteria removal, Solve the problem of exceeding the standard of bacteria in practical process

抗紫外线材料 UV resistant material

外观材料均作抗紫外线处理，保证长期使用依旧如新；
All exterior materials are treated with anti ultraviolet, Ensure long-term use as new as ever;

恒温加热 Constant temperature heating

持续提供 $\geq 92^{\circ}\text{C}$ 热水，解决多人喝水无需等待

Continuous supply $\geq 92^{\circ}\text{C}$ hot water, Solve the problem of drinking water for many people without waiting

超大冷胆 Super large cold tank

超大冷胆，冰水畅饮
多人饮用，清凉消暑

Super large cold tank, drink ice water freely
Provide more cold water for more people

个性定制 Personalized customization

优秀技术团队，提供个性定制服务，为您排忧解难

Excellent technical team, providing customized service, Help you out

型号 MODEL	XC08-09B-WR	
过滤方式 Water purification method	RO 反(渗透过滤) Reverse osmosis	UF(超细微孔过滤) Ultrafiltration
制水速度 Water purification ability	RO 7.8-31.2L/h	UF 50L/h
净水箱容量 Water tank capacity	12L	
热水箱容量 Hot Water tank capacity	3.5-10L	
冷水箱容量 Cold Water tank capacity	5L	
冷水温度 Cold Water temp	4~10°C	
热水温度 Hot Water temp	85~95°C	
制冷器 Cooler	压缩机 Compressor	
产品尺寸 Size of model	380x460x1247mm 或 380x460x1390mm	
包装尺寸 Packing size	530x460x1315mm	
净重 Net weight	RO 33kg	UF 30kg
毛重 Gross weight	RO 36kg	UF 33kg
装柜数量 Container loading qty	40'HQ/220 台	

产品结构图 Product Structure

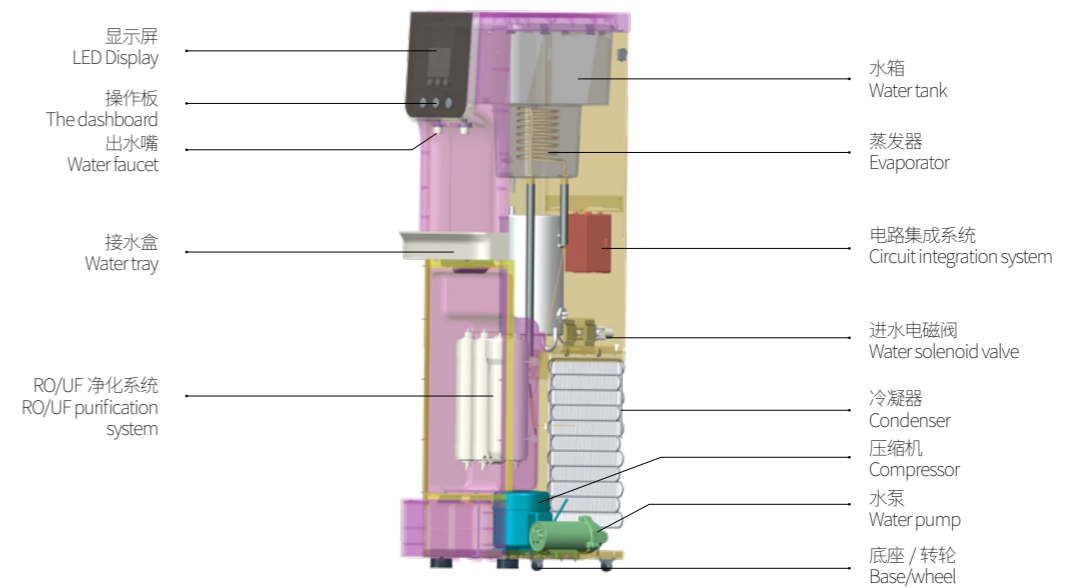

欧普蓝随芯而动
热平衡让享受不再等待

OPNAN Move with the core
Heat balance makes enjoyment no longer wait

XC08-09C-WR

DIRECT DRINKING WATER PURIFIER

直饮净水机



个性滤芯 DIY 定制 Individual Filter Core,DIY Custom-made

超标准配置最多配备 8 级滤芯，随需求可添加特种滤芯，依照个人要求增加矿物，调节 PH 值和酸碱度。

Super standard configuration is equipped with up to 8 levels of filter elements. Special filter elements can be added as required. Minerals can be added according to personal requirements to adjust pH value and pH value.

型号 MODEL	XC08-09C-WR	
过滤方式 Water purification method	RO 反(渗透过滤) Reverse osmosis	UF(超细微孔过滤) Ultrafiltration
制水速度 Water purification ability	RO 7.8-31.2L/h	UF 50L/h
净水箱容量 Water tank capacity	12L	
热水箱容量 Hot Water tank capacity	3.5-10L	
冷水箱容量 Cold Water tank capacity	5L	
冷水温度 Cold Water temp	4~10°C	
热水温度 Hot Water temp	85~95°C	
制冷器 Cooler	压缩机, Compressor	
产品尺寸 Size of model	476x380x1260mm	
包装尺寸 Packing size	530x460x1315mm	
净重 Net weight	RO 33kg	UF 30kg
毛重 Gross weight	RO 36kg	UF 33kg
装柜数量 Container loading qty	40'HQ/220 台	

XC08-01A-WR

DIRECT DRINKING WATER PURIFIER

直饮净水机



抗紫外线材料

UV resistant material

外观材料均作抗紫外线处理, 保证长期使用依旧如新;

All exterior materials are treated with anti ultraviolet, Ensure long-term use as new as ever;

超大冷胆

Super large cold tank

超大冷胆, 冰水畅饮

多人饮用, 清凉消暑

Super large cold tank, drink ice water freely

Provide more cold water for more people

个性定制

Personalized customization

优秀技术团队, 提供个性定制服务, 为您排忧解难

Excellent technical team, providing customized service, Help you out

型号 MODEL	XC08-01A-WR	
过滤方式 Water purification method	RO 反(渗透过滤) Reverse osmosis	UF(超细微孔过滤) Ultrafiltration
制水速度 Water purification ability	7.8-31.2L/h	UF 50L/h
净水箱容量 Water tank capacity	12L	
冷水箱容量 Cold Water tank capacity	5L	
热水箱容量 Hot Water tank capacity	3.5-10L	
冷水温度 Cold Water temp	4~10°C	
热水温度 Hot Water temp	85~93°C	
制冷器 Cooler	压缩机 Compressor	
产品尺寸 Size of model	476x380x1260mm	
包装尺寸 Packing size	530x460x1315mm	
净重 Net weight	33kg	UF 30kg
毛重 Gross weight	36kg	UF 33kg
装柜数量 Container loading qty	40'HQ/220 台	

产品结构图 Product Structure

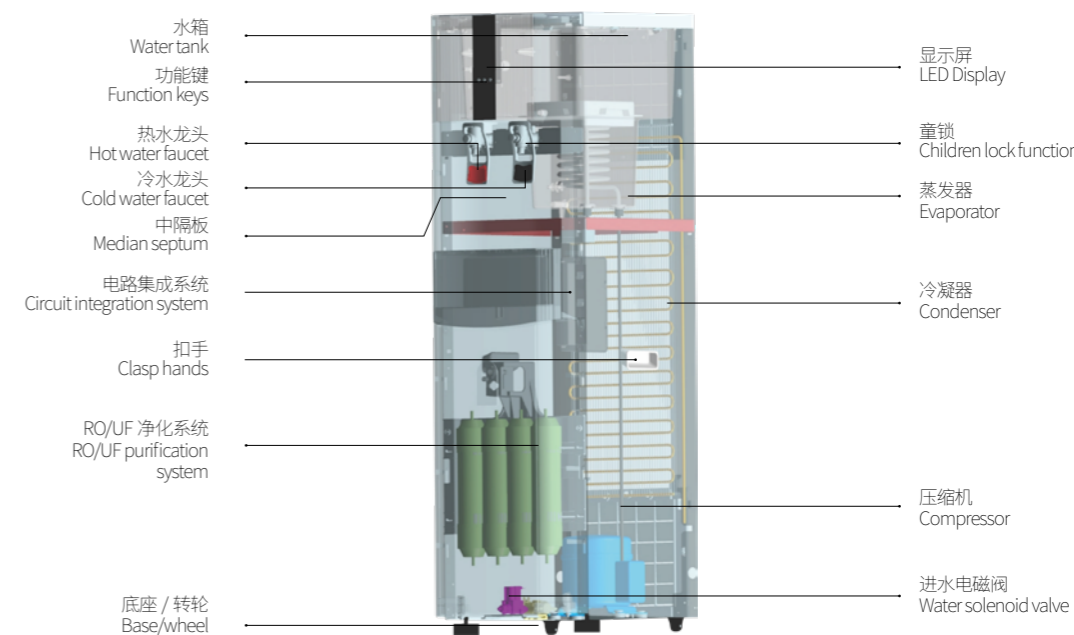

XC08-02A-WR

DESKTOP WATER PURIFIER

台式直饮净水机

尊贵屏显 节能方便

Noble Screen Display Convenient
And Energy-saving

超大净水水箱, 尊贵屏显, 节能方便

Super large pure water tank, noble display screen,
convenient energy saving



防烫保护 安全童锁

Anti-burn Protection Safety Child lock

人性化儿童保护锁设计, 取热水时, 同时按下童锁键才可出水, 有效呵护儿童安全, 使用更放心

Individual child-protection lock design for hot water, only you press "Child Lock Key", you can get hot water then. It effectively protects the child safety and it is more secure in use.

高亮度 LED 显示屏, 寿命长, 微电脑控制, 工作状态即时显示, 感光系统设计, 夜间自动关机节能, 冷热开关分离, 满足个人需求更节能

High Luminance LED display screen of long service life. Micro-computer control, instant display of the working conditions. Light-sensitive system design enables the automatic stop at night so as to save the energy. Cool/hot switch separation satisfies the individual requirements and is more energy-saving as well.

型号 MODEL	XC08-02A-WR	
过滤方式 Water purification method	RO 反(渗透过滤) Reverse osmosis	UF(超细微孔过滤) Ultrafiltration
制水速度 Water purification ability	7.8L/h	50L/h
净水箱容量 Water tank capacity	6.5L	
冷水箱容量 Cold Water tank capacity	3.5L	
热水箱容量 Hot Water tank capacity	1.4L	
冷水温度 Cold Water temp	4~10°C	
热水温度 Hot Water temp	85~93°C	
制冷器 Cooler	压缩机 Compressor	
产品尺寸 Size of model	490x342x520mm	
包装尺寸 Packing size	535x390x575mm	
净重 Net weight	20kg	17.5kg
毛重 Gross weight	21.5kg	19kg
装柜数量 Container loading qty	40'/510	20'/255

产品结构图 Product Structure

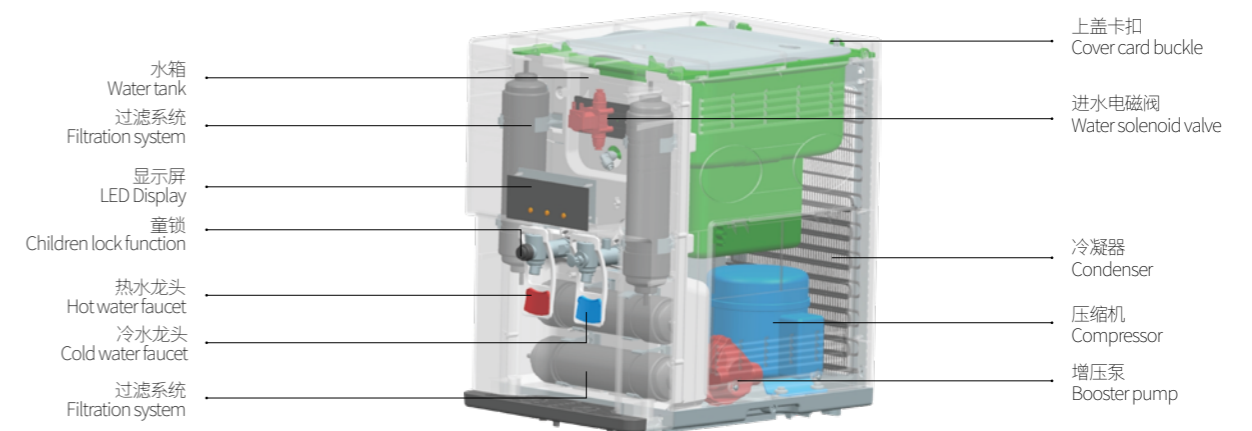

XC08-03A-WR

DIRECT DRINKING WATER PURIFIER 直饮净水机

个性滤芯 DIY 定制
Individual Filter Core,DIY
Custom-made

超标准配置最多配备 4 级滤芯，随需求可添加特种滤芯，依照个人要求增加矿物，调节 PH 值和酸碱度。

Super-standard configuration as high as level-4 of 13" filter core Special filter core is available for special requirements Minerals can be added and PH value can be regulated according to the individual requirements.



型号 MODEL	XC08-03A-WR	
过滤方式 Water purification method	RO 反 (渗透过滤) Reverse osmosis	UF(超细微孔过滤) Ultrafiltration
制水速度 Water purification ability	7.8-31.2L/h	50L/h
净水箱容量 Water tank capacity	5.1L	
冷水箱容量 Cold Water tank capacity	2.3L	
热水箱容量 Hot Water tank capacity	1.4L	
冷水温度 Cold Water temp	4~10°C	
热水温度 Hot Water temp	85~93°C	
制冷器 Cooler	压缩机 Compressor	
产品尺寸 Size of model	450x290x1150mm	
包装尺寸 Packing size	510x330x1215mm	
净重 Net weight	26.5kg	24kg
毛重 Gross weight	28.5kg	26kg
装柜数量 Container loading qty	40'HQ/320 台	

产品结构图 Product Structure

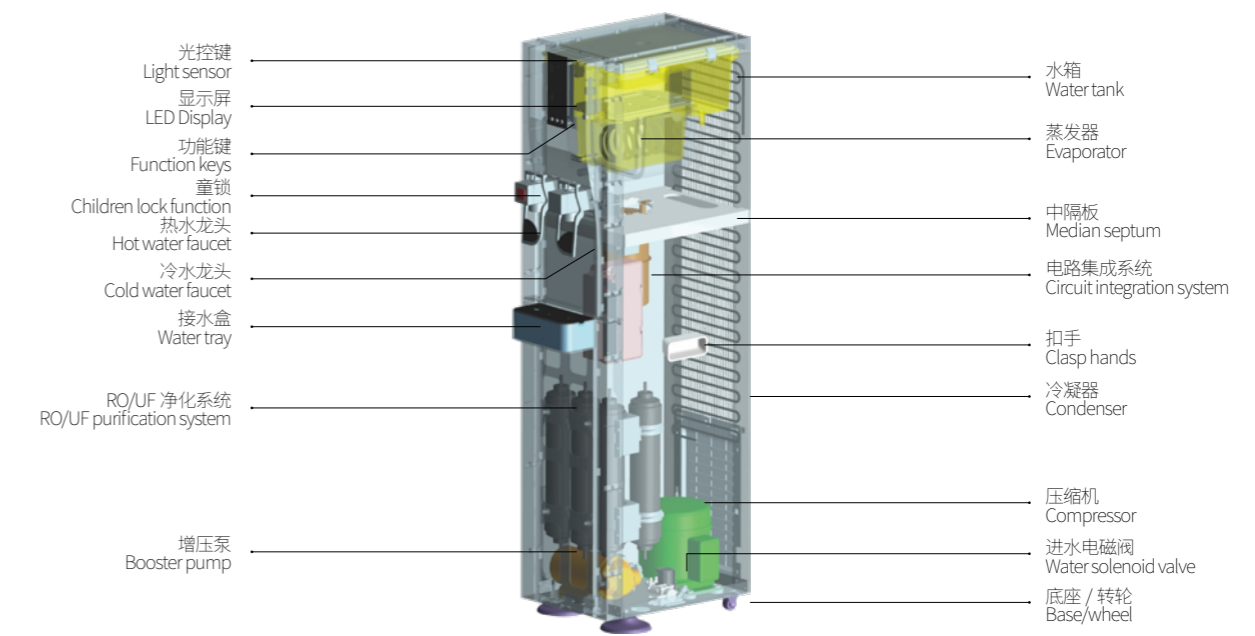

XC08-04A-WR

DESKTOP WATER PURIFIER

台式直饮净水机

触摸感应 轻松接水

Touch Induction
Easy water-taking

触摸感应设计，只需轻轻触碰即可启动出水电磁阀抛弃传统机械手柄，接水变得更轻松

Touch induction design Only a slight touch can just start" Water Outlet Electro-Magnetic Valve" .It abandons the traditional mechanical faucet and gets the water more easily.

冷水箱超大设计

Individual Filter Core,DIY
Custom-made

双层不锈钢制冷管，内部制冷，制冷更快更节能最低水位控制开关，杜绝缺水制冷加热系统四重温度控制保护，杜绝无水加热过热保护，防止意外发生。

Super-large of cool water tank.Double-layer stainless steel refrigeration pipe can freeze from inside.it brings quicker refrigeration and ti is more energy-saving.Low water-level control switch avoid water-lacking.Four protections of temperature control for heating and cooling system to avoid water-less heating and Over-heat. Prevent the product from the accidents.



冷热保障 纯净安全
Cool/Heating Warranty
Safe for use

型号 MODEL	XC08-04A-WR	
过滤方式 Water purification method	RO 反(渗透过滤) Reverse osmosis	UF(超细微孔过滤) Ultrafiltration
制水速度 Water purification ability	7.8L/h	50L/h
净水箱容量 Water tank capacity	5.1L	
冷水箱容量 Cold Water tank capacity	2.3L	
热水箱容量 Hot Water tank capacity	1.4L	
冷水温度 Cold Water temp	4~10°C	
热水温度 Hot Water temp	85~93°C	
制冷器 Cooler	压缩机 Compressor	
产品尺寸 Size of model	467x260x524mm	
包装尺寸 Packing size	530x326x580mm	
净重 Net weight	15.6kg	11kg
毛重 Gross weight	17kg	12.4kg
装柜数量 Container loading qty	40'/616	20'/308

产品结构图 Product Structure

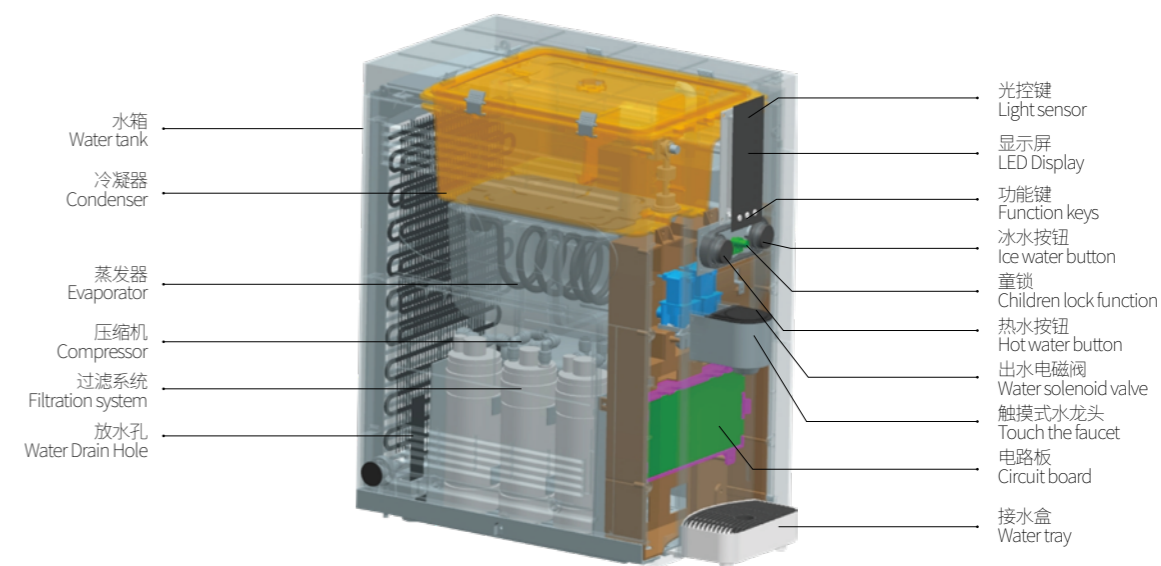

XC08-05A-WR

DIRECT DRINKING WATER PURIFIER

直饮净水机



触摸感应 轻松接水

Touch Induction
Easy water-taking

触摸感应设计，只需轻轻触碰即可启动出水电磁阀抛弃传统机械手柄，接水变得更轻松

Touch induction design Only a slight touch can just start" Water Outlet Electro-Magnetic Valve" .It abandons the traditional mechanical faucet and gets the water more easily.



内置不锈钢制冷设计

Built in stainless steel
refrigeration design

双层不锈钢制冷管，内部制冷，制冷更快更节能最低水位控制开关，杜绝缺水制冷加热系统四重温度控制保护，杜绝无水加热过热保护，防止意外发生。

Super-large of cool water tank.Double-layer stainless steel refrigeration pipe can freeze from inside.it brings quicker refrigeration and ti is more energy-saving.Low water-level control switch avoid water-lacking.Four protections of temperature control for heating and cooling system to avoid water-less heating and Over-heat. Prevent the product from the accidents.

型号 MODEL	XC08-05A-WR	
过滤方式 Water purification method	RO 反(渗透过滤) Reverse osmosis	UF(超细微孔过滤) Ultrafiltration
制水速度 Water purification ability	7.8L/h	50L/h
净水箱容量 Water tank capacity	5.1L	
冷水箱容量 Cold Water tank capacity	2.3L	
热水箱容量 Hot Water tank capacity	1.4L	
冷水温度 Cold Water temp	4~10°C	
热水温度 Hot Water temp	85~93°C	
制冷器 Cooler	压缩机 Compressor	
产品尺寸 Size of model	450x290x1150mm	
包装尺寸 Packing size	510x330x1215mm	
净重 Net weight	26.5kg	24kg
毛重 Gross weight	28.5kg	26kg
装柜数量 Container loading qty	40'HQ/320 台	

产品结构图 Product Structure

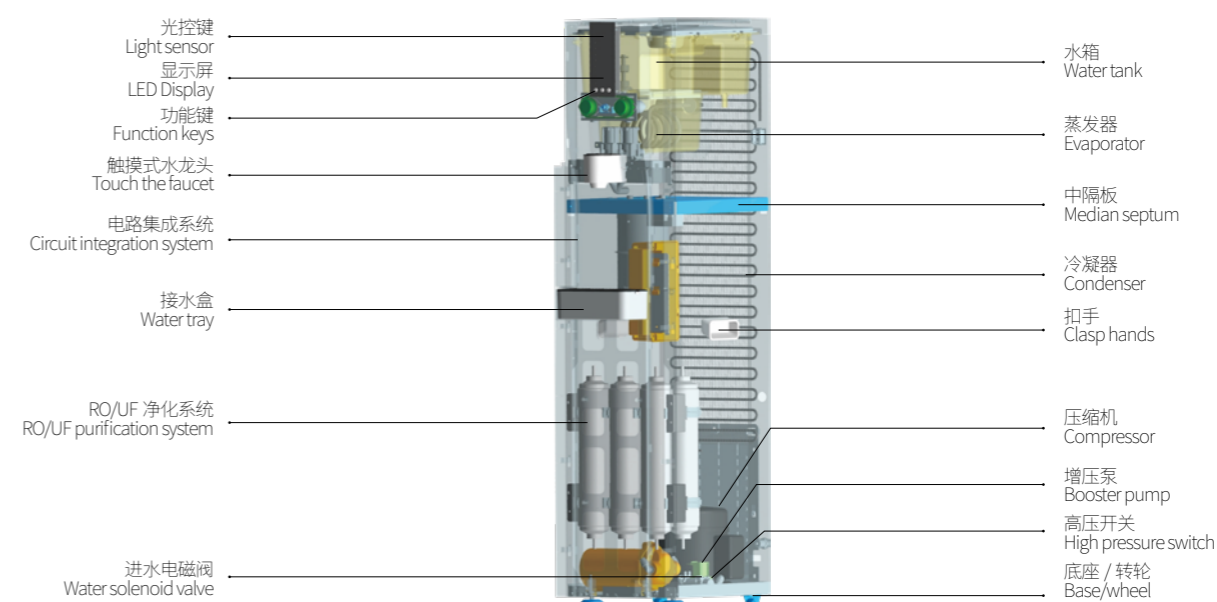

XC08-07A-WR

DESKTOP WATER PURIFIER

台式直饮净水机



三段滤芯设置 Three stages of filter

分别 PP+ 炭棒, UF, 后置活性炭 + 碱性球,
滤芯可以依据要求设置不同配置, 滤芯更换非常便捷。

PP+carbon rod,UF membrane,Post carbon+alkaline ball,
we can also use different filters as per your requirement,
Easy to change the filters.



型号 MODEL	XC08-07A-WR
过滤方式 Water purification method	UF(超细微孔过滤) Ultrafiltration
制水速度 Water purification ability	UF 50L/h
热水箱容量 Hot Water tank capacity	1.2L
冷水温度 Cold Water temp	4-10°C
热水温度 Hot Water temp	95°C
制冷器 Cooler	压缩机 Compressor
产品尺寸 Size of model	415x295x375mm
包装尺寸 Packing size	455x345x435mm
净重 Net weight	UF 13kg
毛重 Gross weight	UF 14.5kg
装柜数量 Container loading qty	20/425pcs

产品结构图 Product Structure

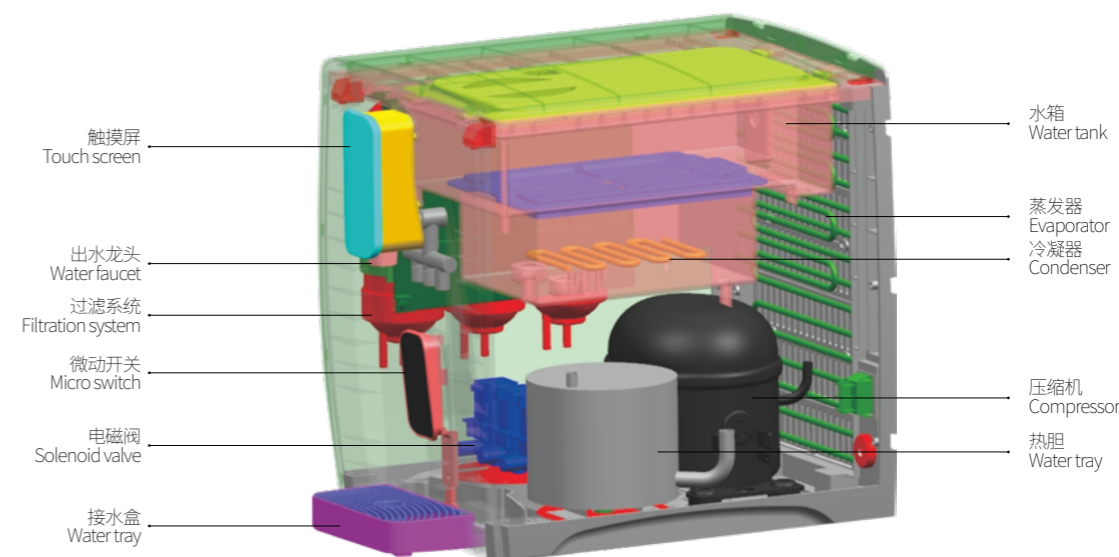

XC08-J1

DESK TOP WATER PURIFIER

台上净水器

无需插电
液晶显示滤芯寿命
No need electricity
LCD display show the life span of the filter



Opnan® 欧普蓝



产品结构图 Product Structure

型号 MODEL	XC08-J1
过滤方式 Water purification method	UF(超细微孔过滤) Ultrafiltration
制水速度 Water purification ability	50L/h
产品尺寸 Size of model	350x280x117mm
包装尺寸 Packing size	465x355x165mm
净重 Net weight	2.50kg
毛重 Gross weight	2.95kg
装柜数量 Container loading qty	20/900pcs



Filter 滤芯

韩式快接滤芯系列

Korean quick connect filter element series



I型 8"



I型 9"



I型 13"

卡接式滤芯系列

Clip on filter element series



工厂流水线和产品展示厅
Factory production lines and showrooms



工厂绿化一角
Plant green corner