

LITE HOME

Track linear light

2022

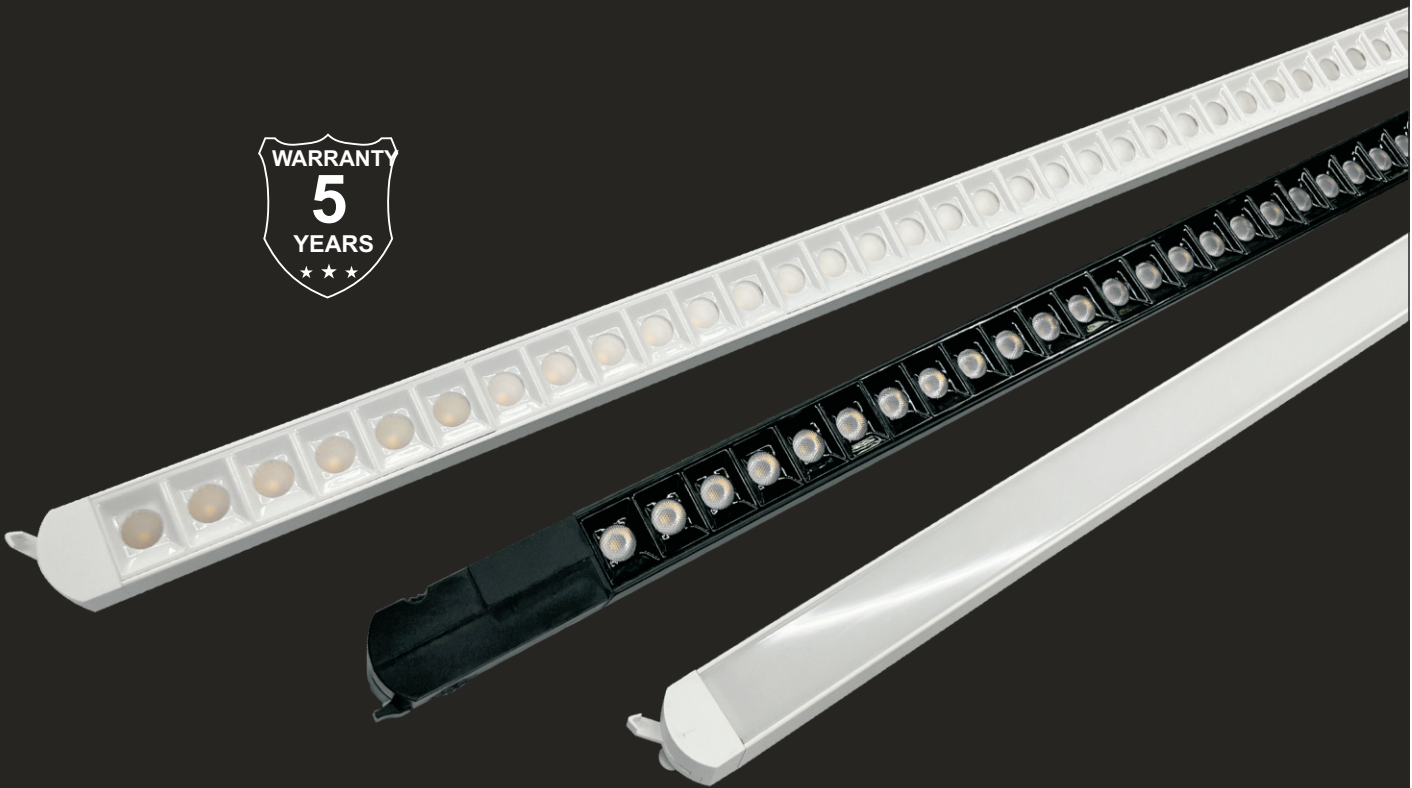

— Born to illuminate the supermarket —

📍 Zhaofeng Industrial Park, No. 16, Shuitian 1st Road, Tongle community, Baolong street, Longgang District, Shenzhen, P.R.C

©2010-2022 LITEHOME. All rights reserved.

Features

- Single-Phase / 3-Phase Track Adapter
- SMD2835 / SMD3030 LED Light Source, UGR<19
- Flicker Free Driver, THD<15%
- High Efficacy: 110lm/w ±5%, up to 160lm/w
- L80B10 Lifespan(Ta=25°C):50,000hrs, Warranty: 5 years
- Material: Black / White / Gray Color Aluminium for Options @ Gray MOQ:3k Pieces
- Trackway for convenient installation and maintenance
- Application: Supermarket / Store / Warehouse / Library / Museum / Exhibition / Office / Hotel



Data Sheet

Article Number	Power (W)	Lumen	Working Current
LH-TLBP2-010-XXXX	10	1000lm	210mA
LH-TLBP2-020-XXXX	20	2000lm	450mA
LH-TLBP3-020-XXXX	20	2000lm	450mA
LH-TLBP3-030-XXXX	30	3000lm	750mA
LH-TLBP4-030-XXXX	30	3000lm	750mA
LH-TLBP4-040-XXXX	40	4000lm	950mA
LH-TLBP5-030-XXXX	30	3000lm	750mA
LH-TLBP5-040-XXXX	40	4000lm	950mA

Light Source	SMD3030
CRI	>80 / >90
Beam Angle	24° / 50°@UGR<19 30°*60° / 60°*90°; 120°@Frosted
CCT	3000K/4000K/5000K/6000K
AC Input	AC220-240V / AC100-277V 50/60 Hz
DC Output	30-40V
SDCM	<4
Power Factor	>0.95
Warranty	5 Years
Operating Temperature	-20~+40°C

* Where the first "X" represents diffuser type, it can be F(Frosted), T(Transparent), G(Grille)
The second "X" represents CCT, it can be W(3000K/4000K), P(5000K), C(6000K)

Efficacy Version

Cover	Standard	Premium
Frosted	100lm/w	125lm/w
Grille UGR<19	100lm/w	125lm/w
Reflection cup	130lm/w	160lm/w

Please note:

1. Above efficacy based on 4000K
2. All values are based on an ambient temperature of 25°C
3. Efficacy tolerance is +/-5% and wattage tolerance is +/-5%

LUMINOUS INTENSITY DISTRIBUTION DIAGRAM

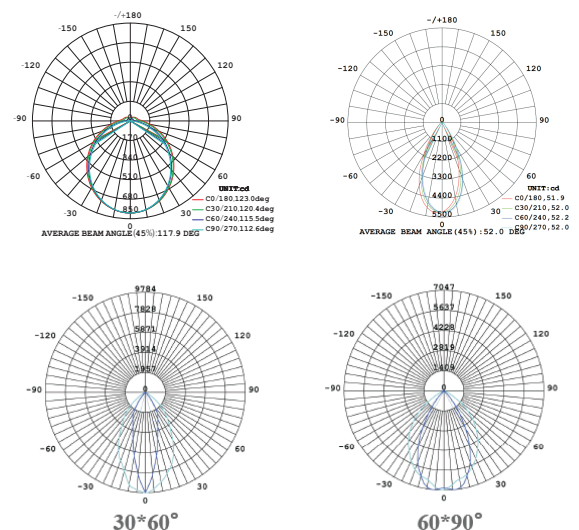

Product Details

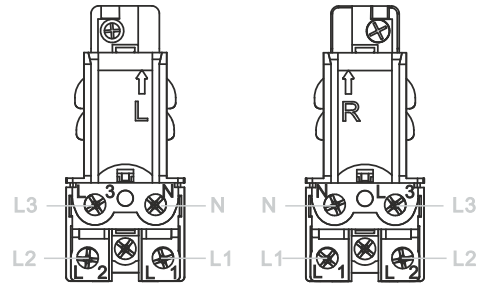
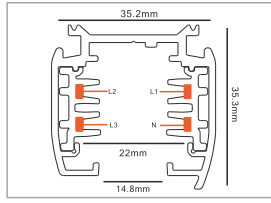
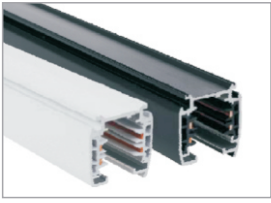

Free Combination



Track linear light
x
Track light

Modelling

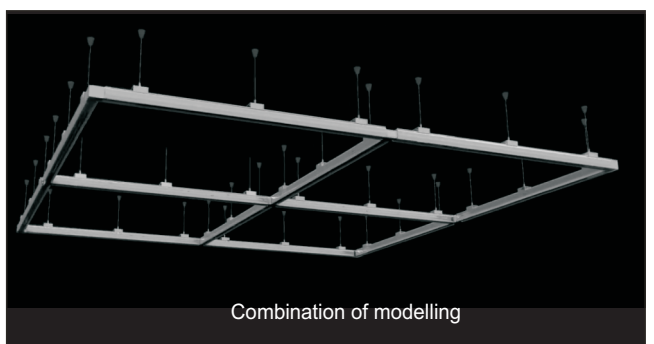
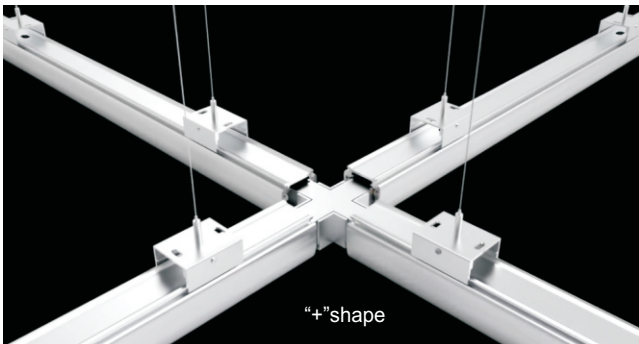
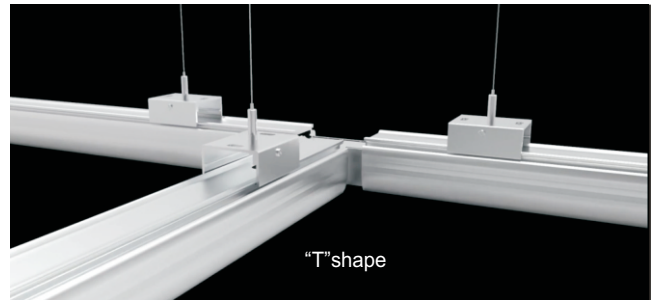
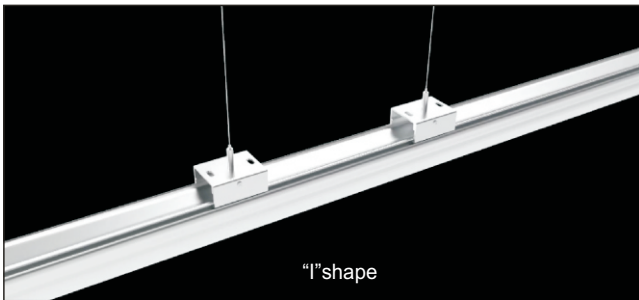

Dimension

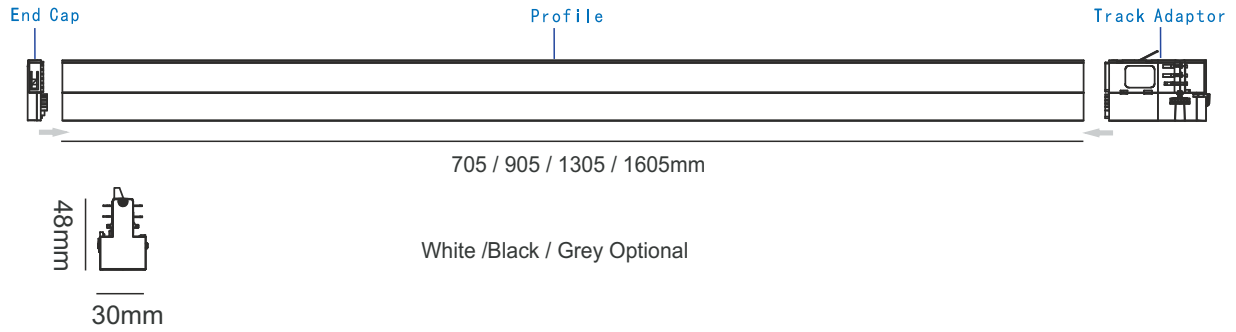

Packaging

Length	Carton Size (20pcs/ctn)	N.W.(CTN)	G.W.(CTN)	20'GP	40'GP	40'HQ
705mm	740*235*390mm	11kg	11.8kg	6700pcs	13900pcs	16680pcs
905mm	950*235*390mm	14kg	15.1kg	5400pcs	11200pcs	13440pcs
1305mm	1340*235*390mm	20kg	21.5kg	3700pcs	7600pcs	9120pcs
1605mm	1640*235*390mm	24.5kg	26.3kg	3000pcs	6400pcs	7680pcs

Installation

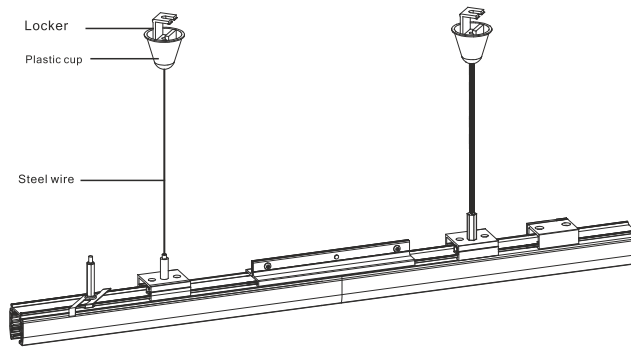

Optional accessories

Ceiling Clamp kit

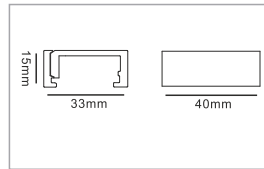

Suspension Clamp for track connection

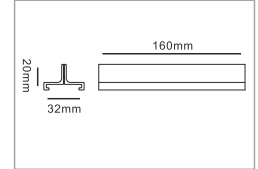

Twisted Connector

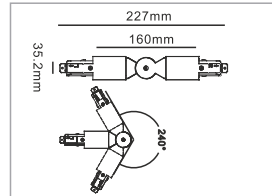

Suspension mount kit

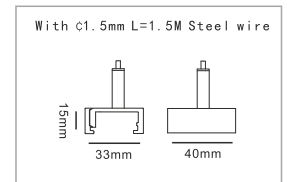

Ceiling Kit with spring

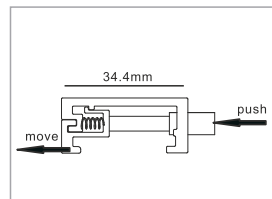

Flexible Connector

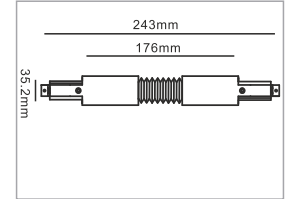

Suspension mount ROD kit

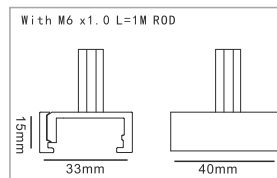

Suspension mount EZCLIK kit

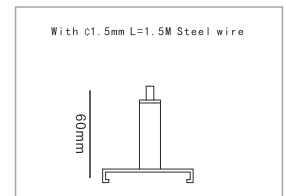

Suspension Kit with spring

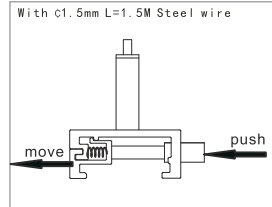

Suspension mount EZCLIK kit

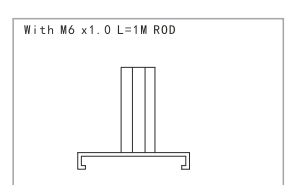

Connector Optional

Track Power Connector (L)

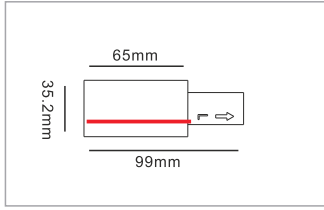

"T" Connector (L1)

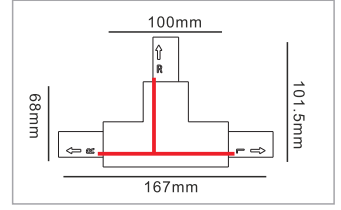

Track Power Connector (R)

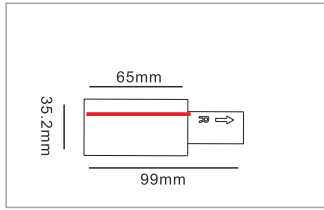

"T" Connector (L2)

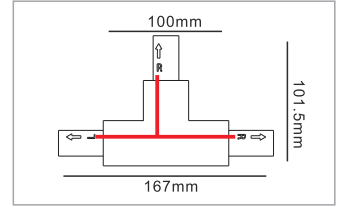

Straight Connector

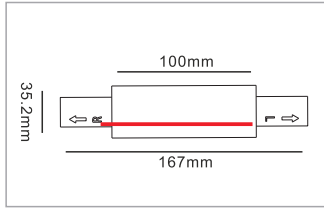

"T" Connector (R1)

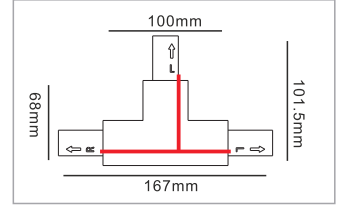

"L" Connector (L)

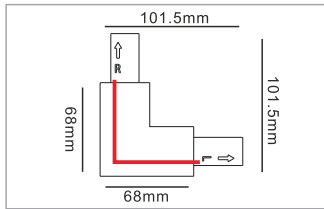

"T" Connector (R2)

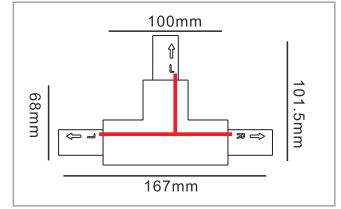
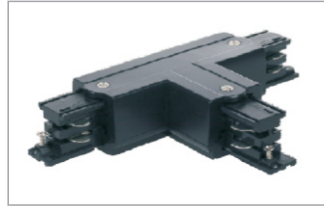

"L" Connector (R)

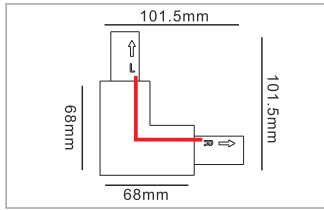
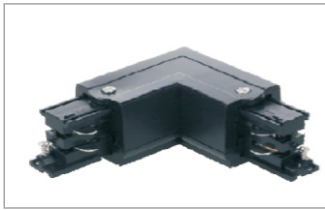

End Cap

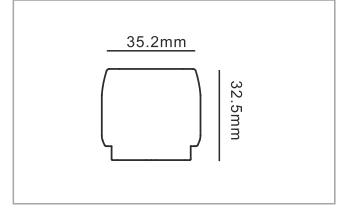

"+" Connector

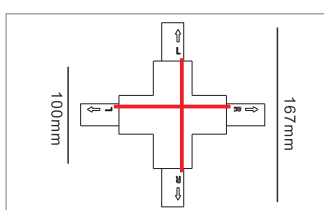
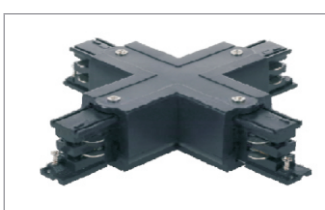

Mini Joiner Connector

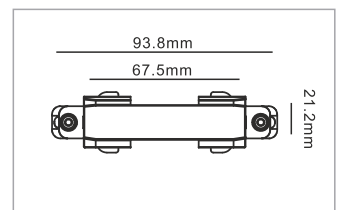

Applications

