



Cryolipolysis machine

360° cooling technology

Non-invasive fat reduction

Any treatment area at any angle

First、 Product description

Welcome to choose our latest product, the diamond ice sculpture instrument. It adopts advanced semiconductor refrigeration + heating+ vacuum negative pressure technology. It's an instrument with selective and non-invasive freezing methods to reduce local fat. Originated from the research and invention of Harvard University in the United States, the technology has passed FDA (US Food and Drug Administration), South Korea KFDA and CE (European Safety Certification Mark) certification, and has been widely used in clinical applications in the United States, Britain, Canada and other countries. As fat cells are sensitive to low temperature, the triglycerides in fat will change from liquid to solid at 5°C, crystallize and age, and then induce fat cell apoptosis, but do not damage other subcutaneous cells (such as epidermal cells, black cells). Cells, dermal tissue and nerve fibers).

It's a safe and non-invasive cryolipolysis, which does not affect normal work, doesn't require surgery, doesn't require anesthesia, doesn't require medication, and has no side effects. The instrument provides an efficient 360° surround controllable cooling system, and the cooling of the freezer is integral and uniform.

It's equipped with six replaceable semiconductor silicone probes. The treatment heads of different shapes and sizes are flexible and ergonomic, so as to adapt to the body contour treatment and are designed to treat double chin, arms, abdomen, side waist, buttocks (under hips). Banana), fat accumulation in thighs

and other parts. The instrument is equipped with two handles to work independently or synchronously. When the probe is placed on the skin surface of a selected area on the human body, the probe's built-in vacuum negative pressure technology will capture the subcutaneous tissue of the selected area. Before cooling, it can be selectively performed at 37°C to 45°C for 3 minutes. The heating phase accelerates the local blood circulation, then it cools by itself, and the precisely controlled freezing energy is delivered to the designated part. After the fat cells are cooled to a specific low temperature, the triglycerides are converted from liquid to solid, and the aging fat is crystallized. The cells will undergo apoptosis in 2-6 weeks, and then be excreted through the autologous lymphatic system and liver metabolism. It can reduce the thickness of the fat layer of the treatment site by 20%-27% at one time, eliminate fat cells without damaging the surrounding tissues, and achieve localization. Body sculpting effect that dissolves fat. Cryolipolysis can fundamentally reduce the number of fat cells, almost no rebound!

Second、 Working mechanism

The ideal temperature from -5°C to -11°C which can induce adipocyte apoptosis is cooling energy to achieve non-invasive and powerful lipid-lowering. Different from adipocyte necrosis, adipocyte apoptosis is a natural form of cell death. It's to maintain the stability of the internal environment. Cells die in an autonomous and orderly manner, thereby effectively reducing fat cells without causing damage to surrounding tissues.



1. The treatment head is attached



2. The cooling energy treats the target fat layer without damaging.

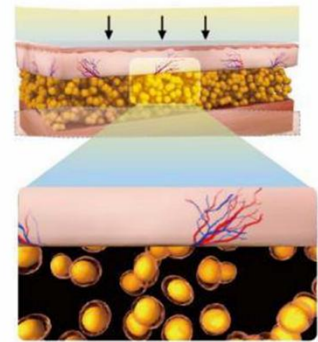

3. Damaged fat cells are broken down and cleared through the natural body process (apoptosis).

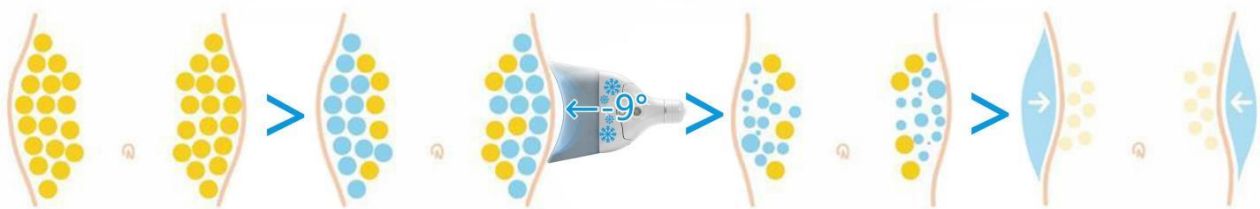

fat swelling in abdomen

convey cooling

fat cells are destroyed

decreased number of fat cells in the abdomen.

Third、 Where are the fat

The fat cells killed by apoptosis are absorbed by macrophages and are excreted from the body as waste products through the body.



Reduction on Hypodermic fat layer

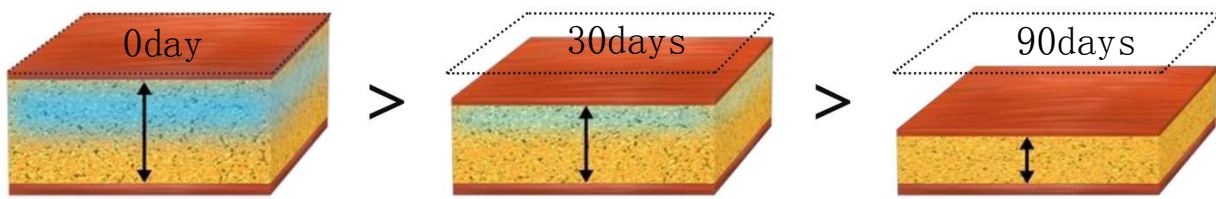

Fourth、 Product advantages and features

- 1、 Double-channel refrigeration grease, double handles and double heads can work at the same time or independently, which is convenient and saves treatment time.
- 2、 One ‘press’ and one ‘install’ probes are easy to replace, plug-and-play plug-in probes, safe and simple.
- 3、 360-degree refrigeration without dead corners, larger treatment area, and full-scale freezing locally has a higher slimming effect.
- 4、 Safe natural therapy: Controllable low-temperature cooling energy causes fat cell apoptosis in a non-invasive manner, does not damage surrounding tissues, reduces excess fat cells, and safely achieves a natural course of slimming and shaping.
- 5、 Heating mode: A 3-minute heating stage can be selectively performed before cooling to accelerate local blood circulation.
- 6、 Equipped with a special antifreeze film to protect the skin. Avoid frostbite and protect the subcutaneous organs.
- 7、 The five-stage negative pressure intensity is controllable, the comfort is improved, and the treatment discomfort is effectively reduced.
- 8、 No recovery period: Apoptosis allows fat cells to undergo a natural death process.

9、 The probe is made of soft medical silicone material, which is safe, colorless and odorless, and has a soft and comfortable touch.

10、 According to the connection of each cooling probe, the system will automatically identify the treatment site of each probe.

11、 The built-in temperature sensor ensures the safety of temperature control; the instrument comes with automatic detection of water flow and water temperature to ensure the safety of the water system.

Fifth、 Anatomical characteristics of the thigh

Customized cartridge 6 cooling probe for thigh.

The anterior and lateral areas of the thighs are mainly composed of muscles, and their tension is strong.

The vacuum suction function of the general cooling probe can cause severe pain and bruising, and the muscle layer is thicker. The cooling energy is not evenly distributed, and the energy cannot be concentrated on the fat layer, resulting in poor curative effect.

There are also non-adsorbent cooling probes on the market that are attached to the surface of the thigh, and the general response is not good. Thigh shaping and fat reduction need to be perfectly focused on the lower layer of the skin fat, in order to achieve the true meaning of the leg contour.

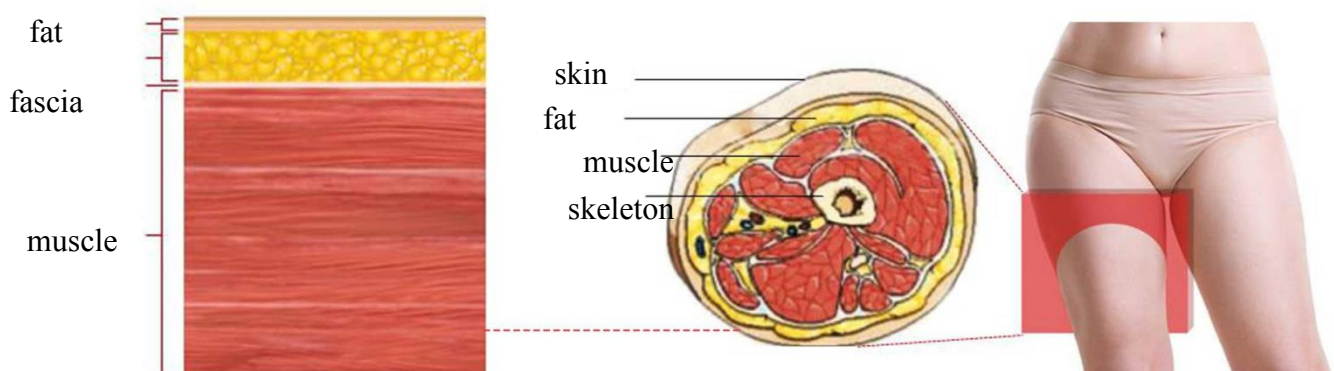

Sixth、 Why choose cartridge 6 probe for thigh? What is the difference with other probes?

The outer and inner depths of cartridge 6 probe are specially customized to achieve the optimization of thigh fat reduction → avoid bruises and redness, and cover 2 times the area at one time

After the operation, before removing the antifreeze film, after removing the antifreeze film

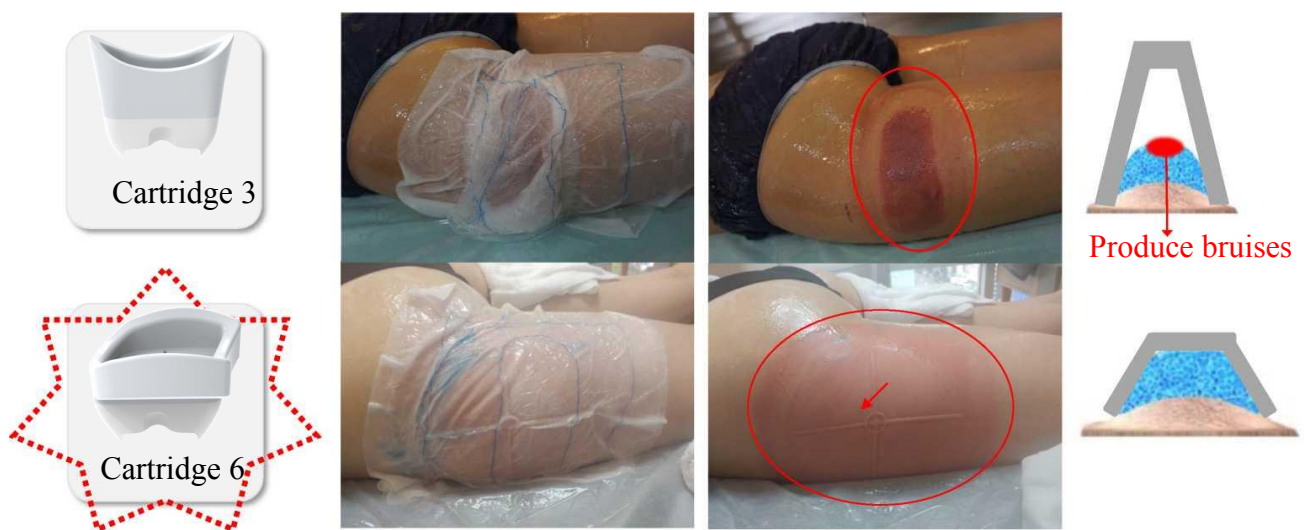

The Cartridge 6 probe has a wide and flat U-shaped area, covering an area of 55 cm in circumference.

Seventh、 Instructions -operation steps for adding water and draining water

1、 Adding water

- In order to facilitate the transportation and transshipment of the instrument, the manufacturer drains all the water in the instrument and the handle before transportation. Pure water must be injected before the instrument is used.

Noted: Be sure to add and drain water when the machine is turned off.

- The right side of the main unit is respectively (inlet) water filling holes according to the label instructions;

The rear of the main unit is respectively (overflow) hole and (outlet) hole according to the label instructions.

Method of adding water : Insert the funnel silicone tube into the water filling hole, and then insert the air nozzle connector into the overflow hole, pour pure water (about 3500 ml) from the funnel until water flows out of the overflow hole, and then start the machine and run for 30 seconds to 1 minute; wait for the water to circulate to On the handle and freezing head, turn off the machine and add water for the second time until water flows out from the overflow hole, indicating that the water is full. Then press the spring buckle above the overflow and water filling hole to pull out the air nozzle connector and silicone tube.

- If the frozen head is found to be hot within 5 minutes before the new machine is turned on for the first time (the air in the handle causes the water flow to not circulate), please stop working immediately and wait for the water to circulate to the handle and the freezing head before starting to work. If the handle is still hot , Please contact the relevant personnel immediately, remember not to start without water!

2、 Water exchange and drainage

- The user of the instrument should remember that the water in the instrument and the handle must be drained out during transportation.
- When the instrument is used frequently, it is recommended to change the water once every 15 days, and then continue to use it to ensure that the water quality

in the instrument is good, to avoid the breeding of bacteria, and to prevent the waterway from being blocked.

- How to change the water? Drain the water before changing the water.**Drainage Method of draining water:** Insert the funnel into the overflow hole, insert the air nozzle connector into the drain hole, and the water in the instrument will automatically flow out. After the water is completely drained, operate it according to the method of adding water .
- 3、 **Releasing water method of handle:**Insert the air nozzle connector into the two water discharge holes of the handle, then raise the handle up until the water is completely discharged, and then press the buttons on both sides of the handle to pull out the air nozzle connector.

Eighth、 Maintenance

- 1、 The instrument must use a plug with a grounding pin, and ensure that the power socket of the instrument is well grounded.
- 2、 The power supply used should be consistent with the specified power supply value marked on the machine, otherwise the machine may not work or even burn out the main board parts of the machine.
- 3、 Ensure that the power supply is stable and adapted. If the local power supply voltage is unstable, it is recommended that the user add a regulated power supply with matching power. Special reminder: The power cord of the socket is required to be more than 1.5 square meters.
- 4、 When using the instrument, please keep away from the wall and keep a 30cm space around the instrument for heat dissipation.

- 5、 The instrument is a high-precision electronic instrument, please don't place the instrument in a high temperature and humid environment.
- 6、 The instrument uses an LCD touch screen. When tapping, try to tap with your fingertips instead of sharp objects.
- 7、 Each accessory is a precision device, so when it is in use and after use, care must be taken to maintain it to avoid shortening its service life.
- 8、 After each use of the accessories, it's recommended to clean them with saline and then dry them with a dry cloth
- 9、 Don't use alcohol or corrosive solvents to clean the host and handle to avoid damage.
- 10、 When using accessories, try to handle them gently, and don't drop them by gravity to avoid damage to the handle.
- 11 When in use, the cord hose of the handle avoids extreme bending and damage
- 12、 When the instrument is not in use, please turn off the power, then unplug the power plug, and place various accessories of the instrument. If possible, cover the instrument with a dust cover.
- 13、 If it's not used for a long time or when it is being transported, the water should be drained clean.
- 14、 It's strictly forbidden to disassemble and modify the equipment without authorization.
- 15、 If the equipment fails, it should be shut down immediately, please contact us.

Ninth、 Product instructions

1、 Installation: vertically align the working handle with the handle socket on the back of the instrument host;

Long press the lock button of the handle, then connect the freezing head to the working handle and place it on the rack.

2、 **Warm reminder!** For the first use, you must fill up with water before starting the machine. Never work without water!

Please refer to page 6 for the method of adding water.

3、 Insert the power cord into the socket at the back of the main unit, turn on the power, turn on the power switch, press the power button, and the instrument will start up immediately.

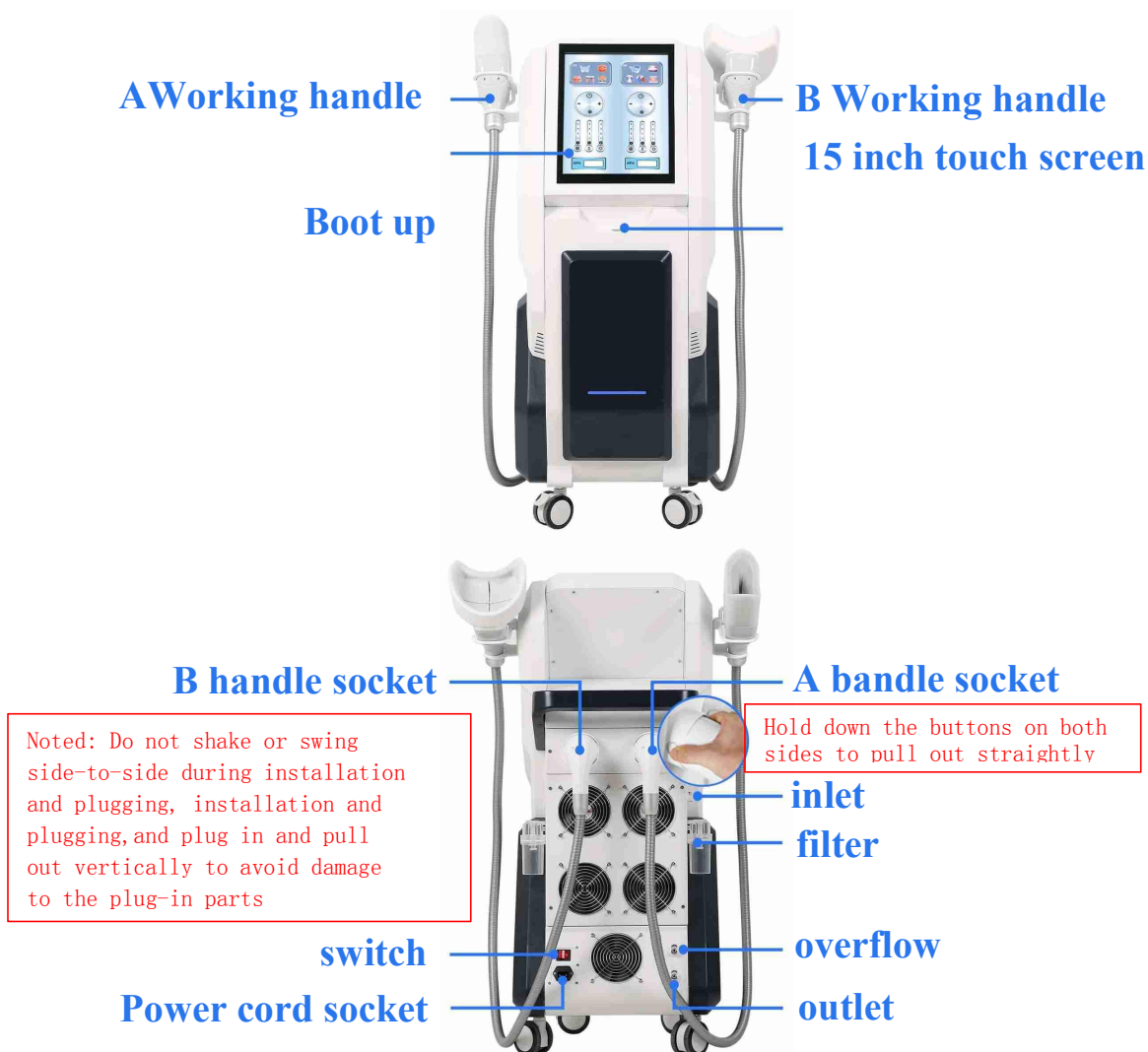

4、Accessories

(1) filter

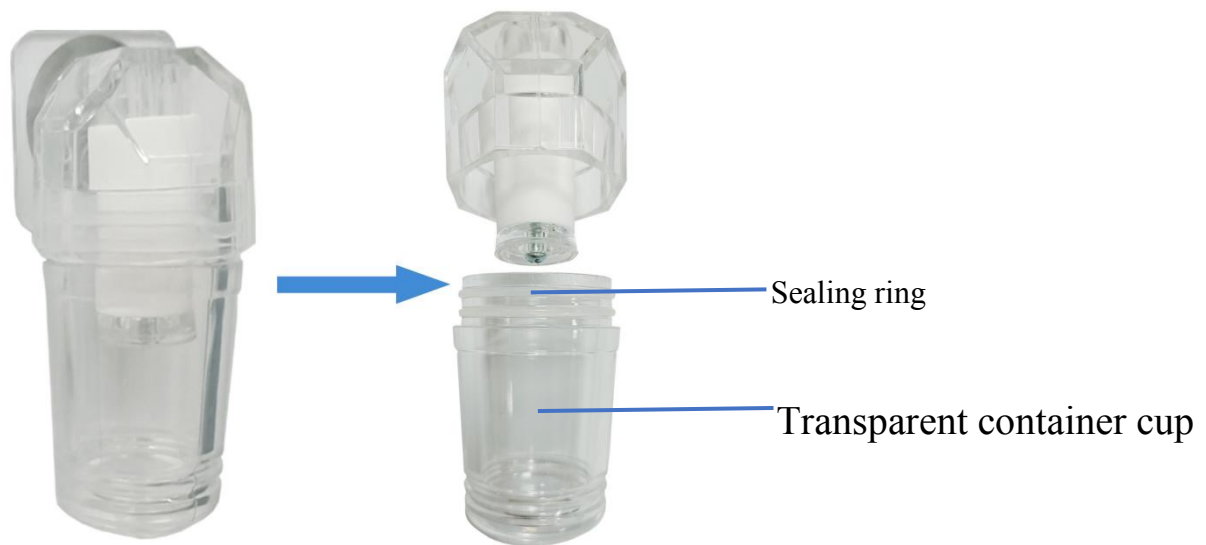

- Disassembly method: twist and pull down at the same time to twist out the container cup.
- Installation method: twist and push upward to install the container cup.
- **Noted!** Checking the container cup before each operation. When there is more than half of the liquid in the transparent container cup, you need to twist the container cup out and clean it up! Because the air flows from the inlet end, passes through the filter body, and filters out moisture or liquid, and then flows back to the air regulating valve and the air pump. Failure to clean up in time will cause damage to the solenoid valve or air pump! When twisting out the transparent container cup for cleaning, pay attention to the sealing ring between the cup body and the filter body. When installing again, install the sealing ring evenly to avoid air leakage!

(2) Filling water funnel and air nozzle joint

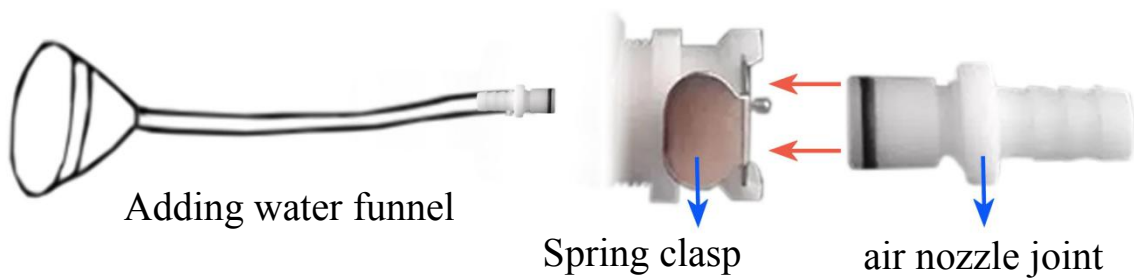

(3) Antifreeze mask (antifreeze film is for single use only, other parts cannot be reused)



Suitable for cartridge 1 and 2 Suitable for cartridge 3 and 5. Suitable for cartridge 4 and 6.

- **Noted!** Before the operation, be sure to stick the antifreeze film on the treatment site, pay attention to the air leakage caused by the fold gap of the antifreeze film, smooth the wrinkles, and apply the antifreeze film to the place where it fits.
- If conditions permit, you can apply a layer of plastic wrap on the antifreeze film to prevent the liquid from the antifreeze film from being sucked into the pipeline!
it's to reduce the excessive suction of liquid in the antifreeze mask into the pipeline and the filter device.

(4) Handle

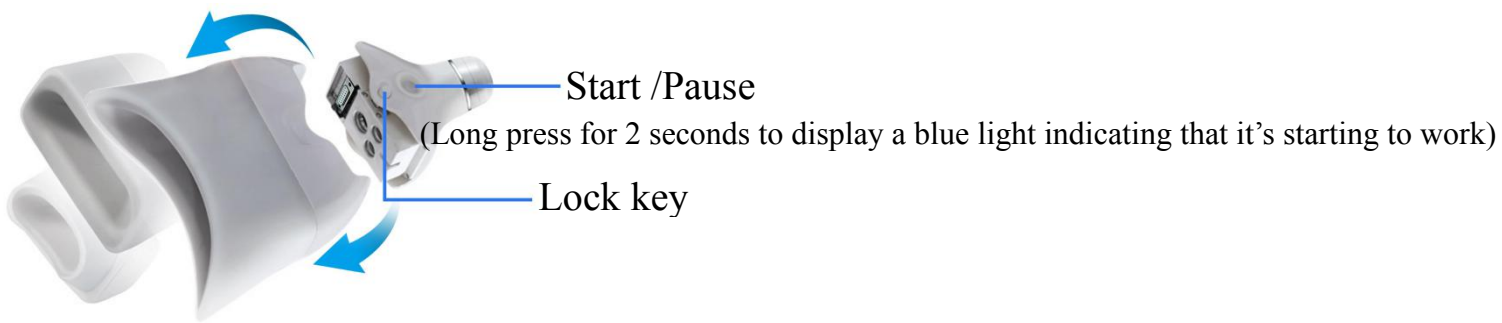

•Installation: first align the hole, then align the probe with the handle, press and tighten, and hear a "click" sound after tightening; Checking whether the probe is installed firmly and safely connected to ensure that it does not disconnect or malfunction during treatment. Ensure that the connection is tight, so as to avoid poor contact and affect the re-operation and use of the instrument.

•Replacement: need to suspend work, or long press the lock button to pull out the probe in a straight line, and replace the required probe

Noted! When installing the probe, be sure to check whether the sealing rubber ring is installed tightly. If the sealing rubber ring is damaged, please replace it with a new one.

(5) treatment head



Cartridge 1
(Standard 1 pc)
Treatment area: 110 × 50.5mm



Cartridge 2
(Optional)
Treatment area: 110 × 80mm



Cartridge 3
(Standard 1 pc)
Treatment area:260×140mm



Cartridge 4
(Standard 1 pc)
Treatment area:330×180mm













Cartridge 5
(Standard 1 pc)
Treatment area:200×140mm



Cartridge 6
(Standard 1 pc)
Treatment area:250×190mm

- According to the different areas, choose different treatment heads. The skin of the operating part must be tightly integrated with the probe, and there should be no gaps. If there is a gap or the handle cannot be sucked!
- After using the probe each time, it's recommended to wipe the probe with normal saline or 50-70% isopropanol and wipe to keep it clean and dry;
- do not immerse the probe in liquid Avoid direct sunlight or extreme high temperature, store in a cool and clean place.
- Don'tot touch the silicone with sharp tools to avoid cutting the probe

Tenth, A variety of professional customized probes, perfect bodycontour

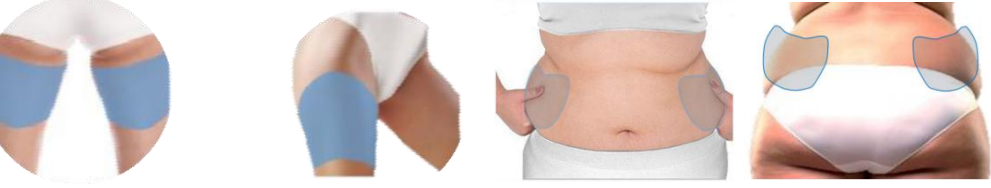
1		<p>-Suitable for small fat pockets and curved contours</p>
	<p>suitable for fat thickness is more than 10-15mm</p>	 <p>* double chin * armpit * knee</p>
2		<p>-Suitable for small fat pockets and flat head contours</p>
	<p>suitable for fat thickness is more than 10-15mm</p>	 <p>* double chin * Back * Inner knee * Arm</p>
3		<p>-Suitable for wide and curved contours</p>
	<p>suitable for fat thickness is more than 20-25mm</p>	 <p>* abdomen * Belly * Lower back fat * Hip line</p>
4		<p>-Suitable for large fat pockets and large fat deposits</p>
	<p>suitable for fat thickness is more than 25-30mm</p>	 <p>* Lower abdomen * Upper and lower abdomen * Back fat</p>
5		<p>-Suitable for large fat bags and flat contours</p>
	<p>suitable for fat thickness is more than 15-25mm</p>	 <p>* abdomen * Inner thigh * Back</p>
6		<p>-Suitable for the thigh area; flat and wide fat areas, etc.</p>
	<p>suitable for fat thickness is more than 20-30mm</p>	 <p>* Front and back of thighs * Outer thigh * Waist fat * Lower back</p>

Eleventh、 Interface introduction

1、 After the instrument is turned on, it enters the boot interface.

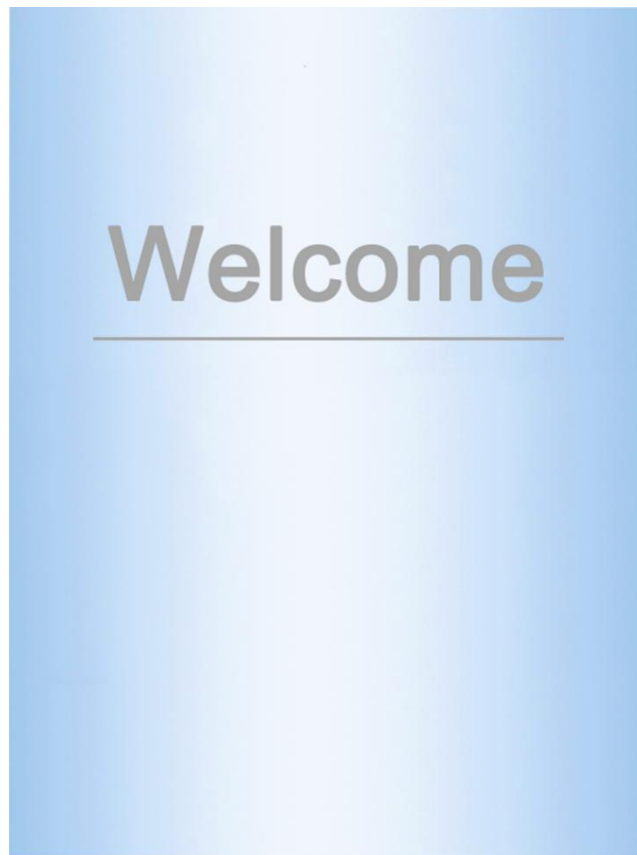

2、 Select it according to the corresponding gender, age and Fat thickness , and then click to enter into the working interface.

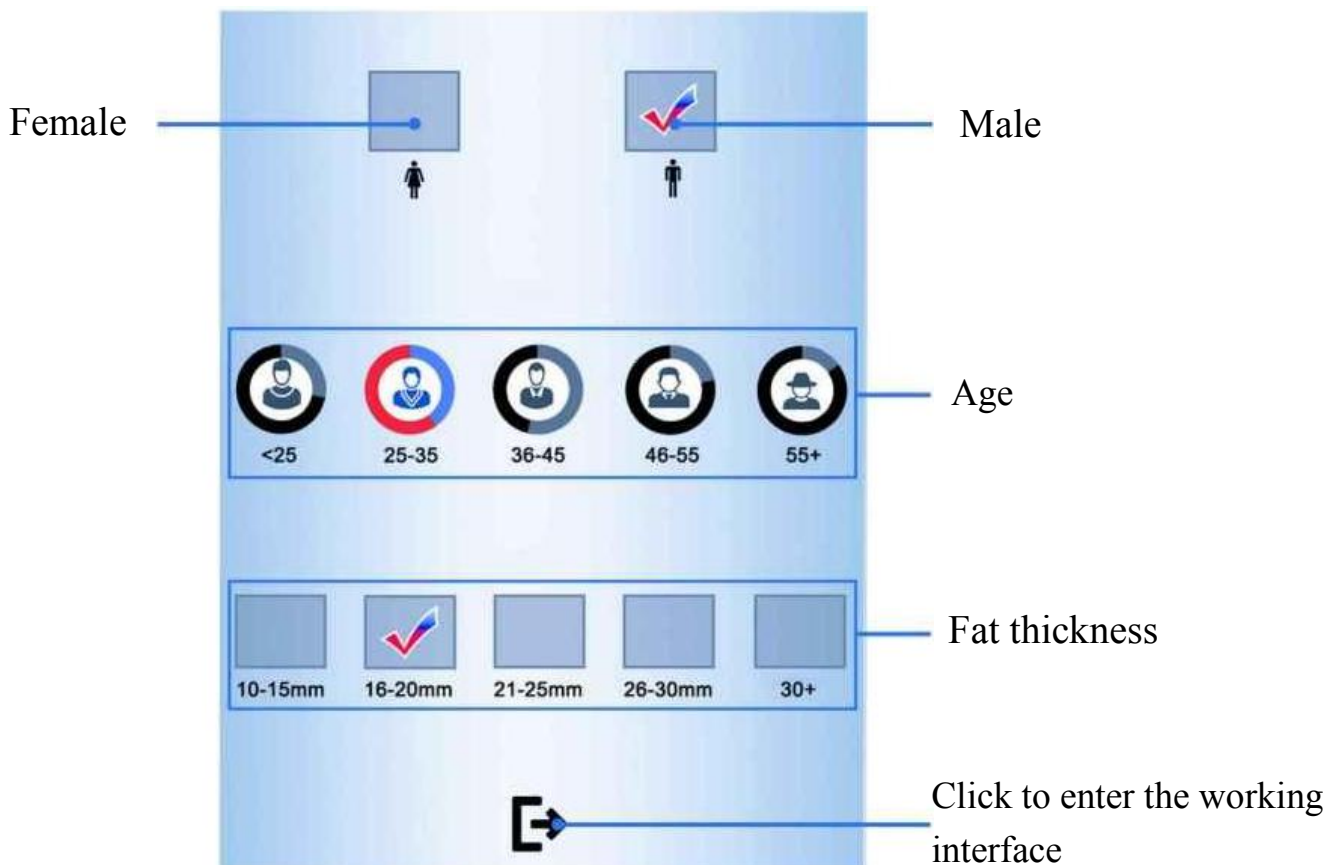

3、Click  to enter the working interface.

A represents the right handle

B represents the left handle

Automatically identify the installed probe (if cartridge 3 is installed, it will display A3)

Automatically identify the installed probe (if cartridge 6 is installed, it will display A6)

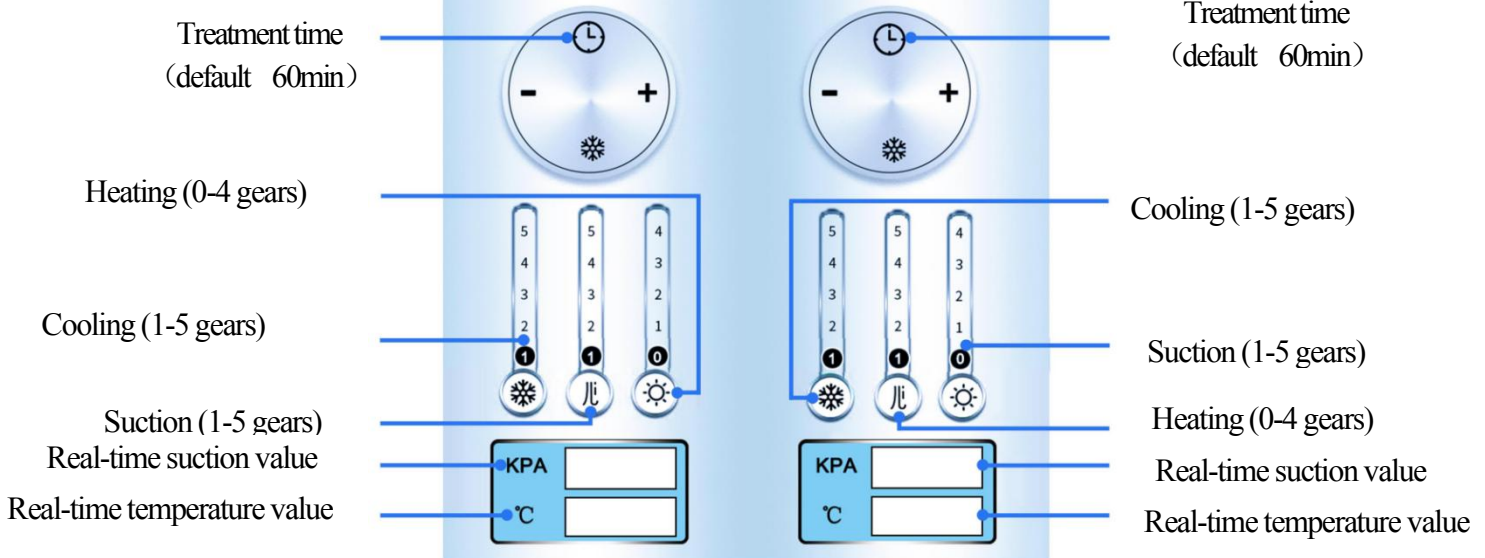







Introduction of working interface:

- A represents the right handle, which automatically recognizes the treatment site according to the installed probe.
- B represents the left handle, which automatically recognizes the treatment site according to the installed probe.

Remarks: The two handles can work independently or at the same time, and the parameters can be adjusted independently.

- Setting the treatment time: 1-99 minutes range can be adjusted, click [+] and [-] to adjust.

The system defaults to 60 minutes, and the treatment time is set according to different parts and specific conditions.

-  Cooling energy: 1-5 gears, click the number or  icon to adjust.
-  suction power: 1-5 gears, click the number or  icon to adjust.
-  heating energy: 0-4 gears, click the number of  icon to adjust. the heating stage works for 3 minutes, if heating is not required, setting it to 0 gears. system default 0 gear.
- Real-time suction value: display the real-time value according to the set suction gear.

Twelfth、Contraindications

If you have the following conditions, cryolipolysis is not recommended:

- 1、 Women who are in menstruation, pregnancy or lactation.
- 2、 Thin people with obesity (BMI) below 18;
- 3、 Minors are generally not recommended to receive such treatment.
- 4、 Patients with abnormal coagulation function or mental disorders.
- 5、 Patients with hernias at the treatment site or adjacent sites, local varicose veins;
- 6、 Recently, having had skin grinding operation or scar tissue;
- 7、 Skin problems such as open or infectious wounds, eczema or dermatitis at the treatment site;
- 8、 Those patients with Tumor, cancer, hypertension, diabetes, kidney and liver disease, heart disease and infectious disease (such as hepatitis B, AIDS, etc.)
- 9、 There are any implanted medical devices in the body (such as pacemakers, defibrillators or rhythm regulators);
- 10、 Cold hemoglobinemia, paroxysmal cold hemoglobinuria, cold urticaria, peripheral circulatory disorders, Raynaud's disease, or a history of similar low temperature intolerance is not recommended for such treatment.

- 11、 It is recommended to consider treatment after one year after the treatment site has undergone surgical operations such as appendicitis.
- 12、 Customers who have been implanted to lose weight can wait 3 months before receiving cryo-fat treatment.
- 13、 After liposuction or other bariatric surgery, you can receive treatment after six months to one year. If the subcutaneous tissue is hard, it is recommended not to do it first.
- 14、 Discontinue any anticoagulant drugs that affect blood flow within two weeks before surgery; OTC drugs (such as aspirin, antibiotics, and fish oil) may also cause skin damage.

Thirteenth 、 Recommended treatment frequency and interval

It's usually recommended 3-5 times as a complete course of treatment, with an interval of one month each time.

The length of the treatment time depends on the body part to be treated and the thickness of the individual's fat layer. We recommend the following treatment time for each part of the body: relatively wide parts for 40 to 60 minutes each time (such as abdomen, belly, thighs, etc.) For narrow areas is 20 to 30 minutes. (such as double chin, armpits, arms, etc.)

Fourteenth、 How to design the operating part?

- The patient's standing state is designed to accurately check the fat accumulation.

- Designing the target area to focus on the parts with more fat.

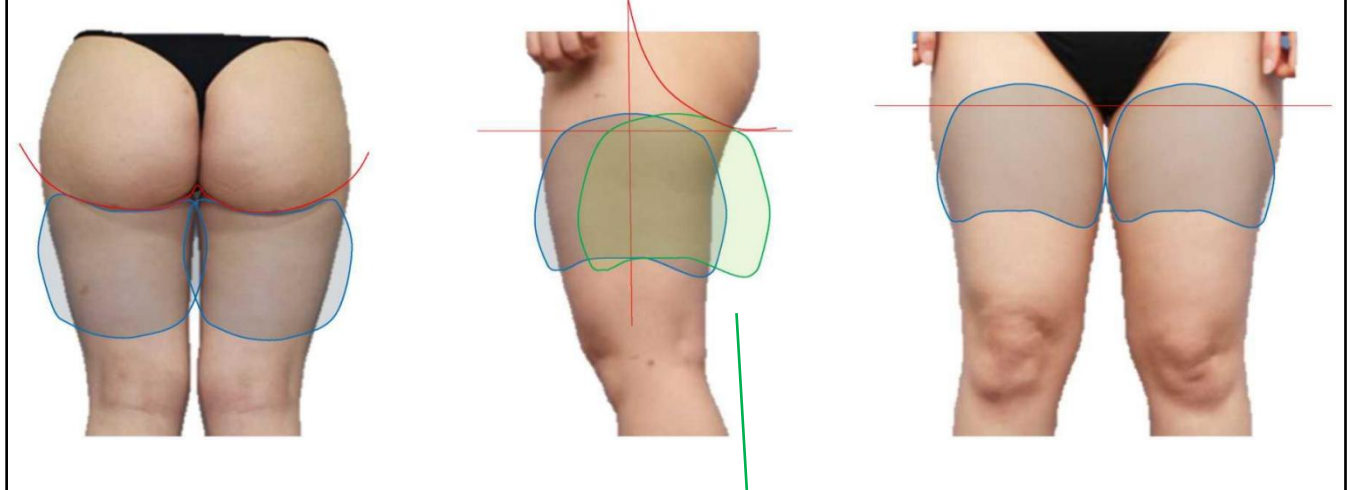

Determine where the fat is concentrated, and flexibly move the design to draw the active part.

- Considering factors of the operating design plan :fat thickness, uneven curve and length of the treatment area.

- Covering a large area of action, effective and long-lasting adsorption.

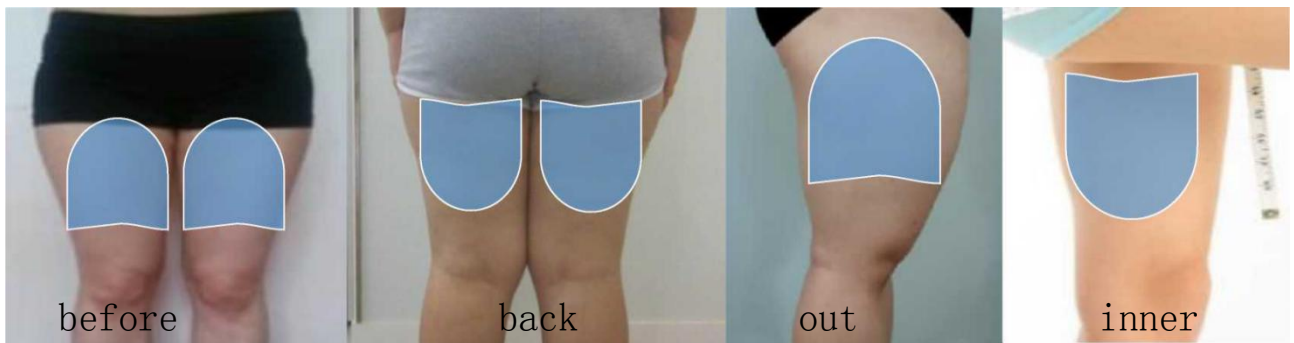

- Acting on the front, back, outside and inside of the thighs.

- Check and palpate the target treatment area.

- Mark the treatment area with a line pen.

- Leave 1 inch at the mark

(Due to negative pressure adsorption)



Fifteenth、 Treatment steps:

1、 First using the line drawing tool to plan the area that needs to be care, measure the size of the treated area and record it;

2、 Selecting the appropriate probe;

3、 Setting the corresponding parameters on the system, and randomly adjusting the negative pressure and cooling temperature according to the customer's specific situation; It's recommended that the cooling energy is in gear 3, and the suction is in gear 1-2 first (if the suction cannot be absorbed, add another gear).

(Individuals have individual differences in their ability to withstand energy. It is recommended that energy should be gradually adjusted from small to large according to customers' ability and feelings.)

4、 Open the package and take out the antifreeze film; unfold the folded antifreeze film and stick the antifreeze film on the treatment area;

Add the remaining essence to the skin to smooth out wrinkles and squeeze out all bubbles to ensure that it fits well;

5、 Press and hold the start button for 2 seconds on the handle to start treatment, press the probe gently and firmly to the center of the antifreeze film of the treatment area, confirm the suction part, and then slowly loosen the handle;

(where the treatment head is in contact with the skin There must be an antifreeze film to avoid frostbite. So it is recommended that the treatment be placed in the middle of the antifreeze film.)

6、 During the treatment process, you need to pay attention to observe and ask the guests' feelings at any time. If the customer feels that the suction is large and

uncomfortable, the suction can be reduced by one level to ensure that the skin can be sucked tightly.

7、 According to the specific treatment site, the treatment is about 30-50 minutes.

8、 At the end of the treatment, use your fingers to gently pry the edge of the treatment head and gently remove the treatment head; remove the antifreeze film to clean the skin; the inside of the treatment head must be thoroughly cleaned.

Sixteenth、 Precautions after operation

1、 Do not wash the part with water within 24 hours after the operation, and do not scald the part with hot water and exercise vigorously within 48 hours;

2、 Note that the postoperative part should be kept dry and try not to scratch.

3、 It is recommended not to drink sugary beverages, coffee and tea within 48 hours after surgery, but to drink plenty of boiled water;

4、 Don't eat irritating foods (such as peppers, wine, raw onions, etc.) within one week after surgery;

It is recommended to eat a reasonable diet (reduce greasy, high-calorie food) and exercise after surgery to prevent the rebound of local obesity.

Seventeenth、 The difference between 360° all-round cooling and traditional cooling plates on both sides

360° surround sound heat dissipation of Diamond ice sculpture is different from the traditional cooling method on both sides. The 360° surround cooling technology can increase the efficiency by up to 18.1%, allows cooling to the entire probe, how many area is adsorbed, how many area is treated, and the adsorbed

area is frozen in a 360° omni-directional way without dead corners, resulting in more effective removal of fat cells.



360° all-around cooling system

* The cooling energy covers the target treatment area uniformly to the maximum extent, the treatment area is larger, and the effect is better

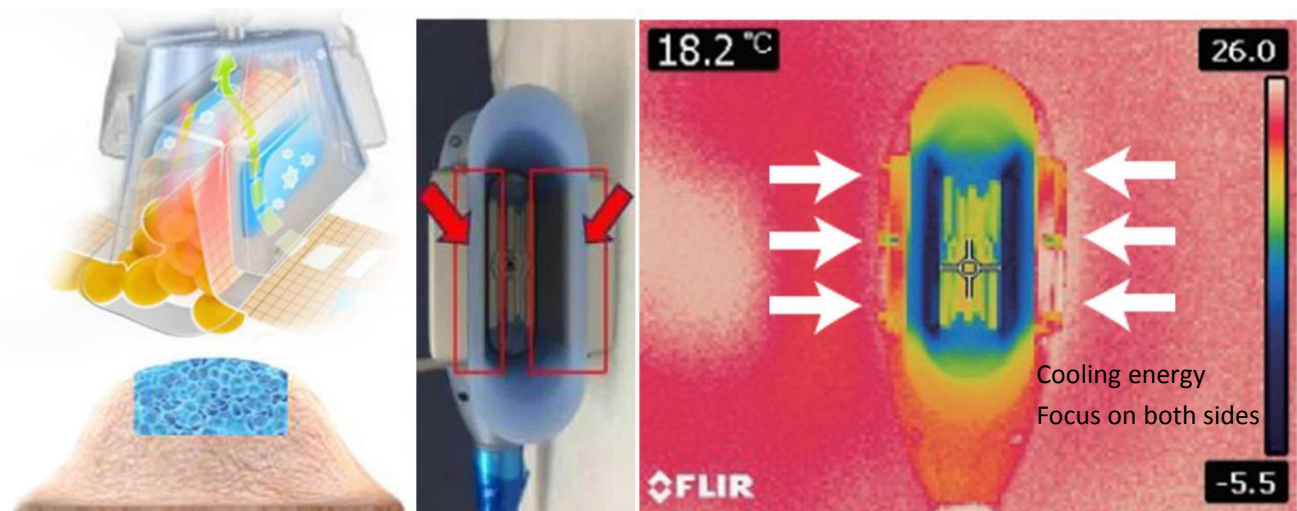

Traditional cooling plate on both sides

* The cooling module is only located on both sides of the treatment head, and only the two sides have a freezing effect.

360° around the cooling area

The general 360° cooling plate area in the market

Traditional cooling plate on both sides



Eighteenth、 The effect of vacuum suction (compared with non-negative pressure suction cooling plate)

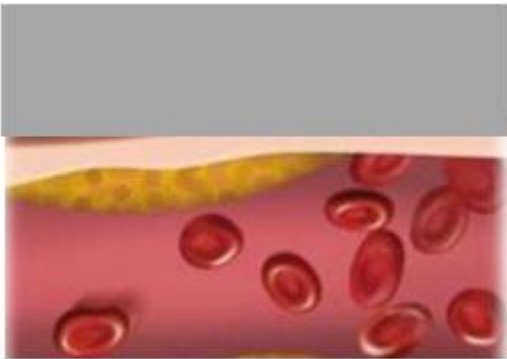

Cooling plate without negative pressure adsorption

Blood flow and body temperature tend to remain constant.

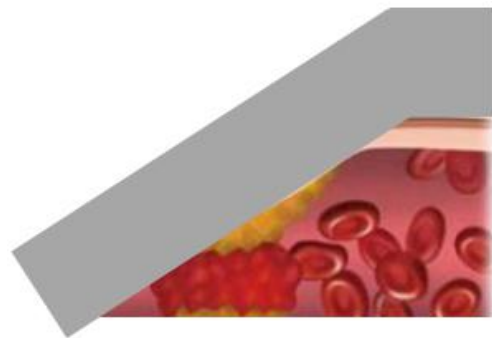

Cooling after adsorption

Suction blocks blood flow, allowing low temperature to reach adipose tissue

The clinical effect is better if blood circulation is blocked and fat freezing is accelerated.



Nineteenth、 Experimental proof

Frozen fat is a non-invasive method to selectively reduce local fat problems. Using mini pigs as an experimental model to find an improvement method for cryo-lipolysis treatment --- using a diamond ice sculpture instrument to treat a group of female mini pigs' abdomen, using three-dimensional photography, ultrasound, microscopic pathology and blood lipid level analysis to test the treatment Effect, and then determine the mechanism, efficacy and safety of cryolipolysis treatment.

■ Histological changes of diamond ice sculpture treatment---1

Staining Method of Hematoxylin & Eosin

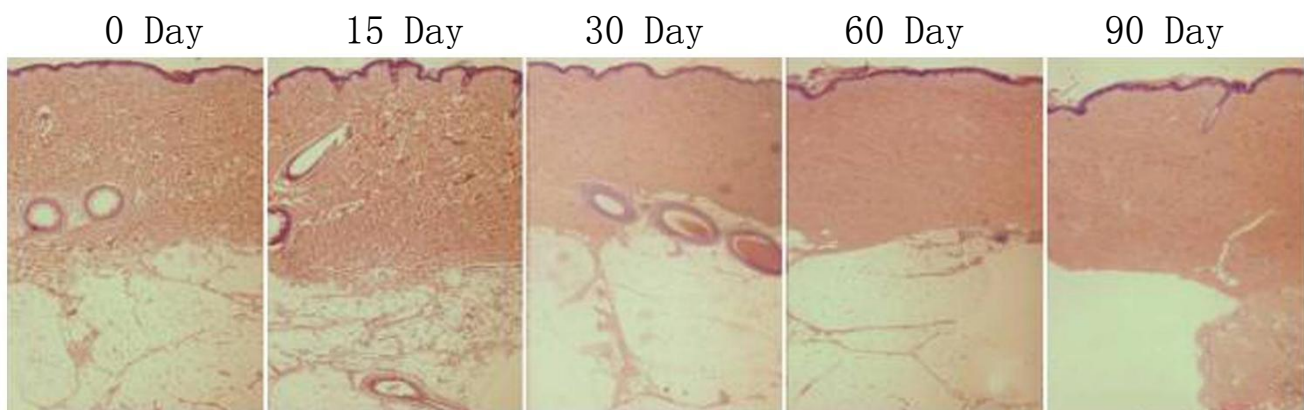

After 0 days, 15 days, 30 days, 60 days, and 90 days after diamond ice sculpture treatment, the results of hematoxylin & eosin staining cell test showed that after 30 days of treatment, there was fat cell reduction, no epidermal insufficiency, and no abnormal inflammatory reaction in the dermis. And there is no necrosis of soft cell tissue.

| Histological changes of diamond ice sculpture treatment---2

Oil red O staining method of fat cell

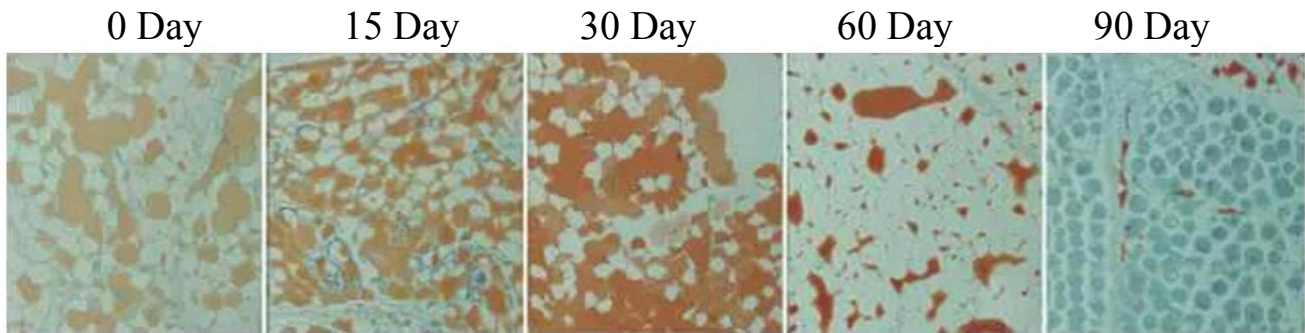

After 0 days, 15 days, 30 days, 60 days, and 90 days after the diamond ice sculpture treatment, the results of the oil red O staining cell test showed that the fat cells decreased after 30 days of treatment.

| Histological changes of diamond ice sculpture treatment---3

Three-dimensional contour camera Thermal imaging camera

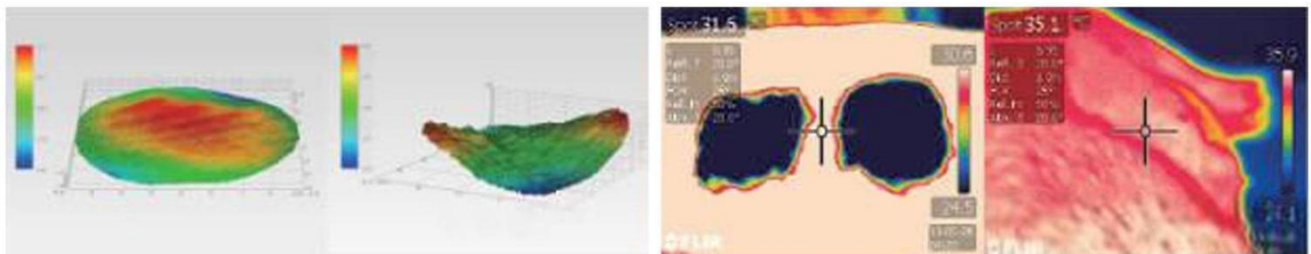

In a trial using mini pigs as a model, the diamond ice sculpture treatment successfully reduced abdominal fat. Microscopic pathological results prove that non-invasive low temperature response can selectively destroy fat, and shows an increasing trend of precursor fat cell differentiation and lipid catabolism activation; especially 30 to 60 days after treatment, it can cause fat tissue increase in the level of PPAR α within.

Histological changes of diamond ice sculpture treatment---4

Ultrasound display

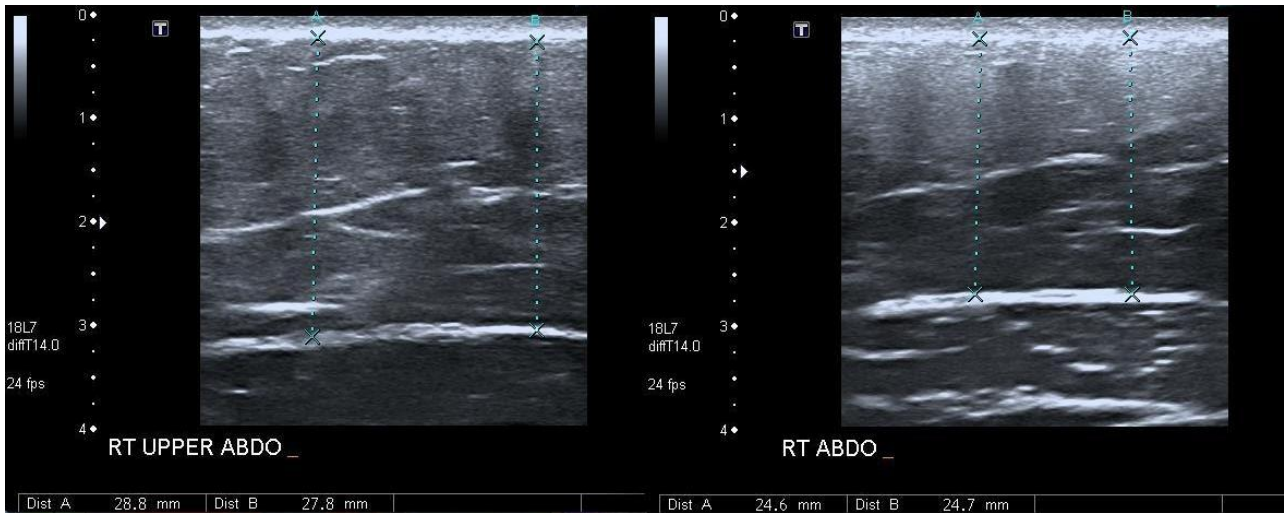

Before

2 months later

Twentieth、 Effect comparison diagram





Twenty-first, Common problems

Q1:Does the customer need to avoid all medicines during the freezing lipolysis period?

Customers should not take any drugs that affect blood flow 10 days before treatment.

OTC drugs such as aspirin, antibiotics, and fish oil may also cause skin damage, so it should not be taken 10 days before treatment.

Q2:What is the general immediate feeling after freezing lipolysis?

After the treatment, the treated area will feel weak or stiff. Some customers will observe a dark red on the treated area, but it will subside after a few hours. After treatment, customers can immediately resume their daily activities.

Q3:How long does it take for freezing lipolysis treatment?

It's recommended that a treatment takes 30-50 minutes. The operator needs to determine the intensity and time of freezing lipolysis according to the area to be treated. During the treatment, the client can adopt a comfortable posture to relax, sleep, read or listen to music. Please be careful not to exceed the recommended treatment time.

Q4:How long does it take to recover after treatment?

Cryolipolysis is completely non-invasive and has no surgical damage at all. Therefore, daily activities can be carried out immediately after treatment.

Q5:What will you feel during treatment?

The first feeling is that the skin is sucked. In the first 10 minutes, freezing may produce a sensation similar to "sting" or other discomfort, and then, the treated area will only feel cold and numb. When the treatment is over and the treatment head is removed, the treatment area will feel cold and stiff. Massage after freezing will enhance the therapeutic effect.

Q6: It's cold and freezing, will that frostbite the skin? Will it cause cold womb

It has a built-in sensor for freezing detection safety measures to accurately monitor the temperature and protect the tissue from damage.It will not be cold womb,The freezing detection treatment is aimed at the superficial subcutaneous fat. The adipose tissue is sucked into the cooling grip through suction, and the temperature of the treated tissue is reduced from the body temperature to a stable 5 degrees Celsius to make it crystallized, instead of minus ten degrees in the grip. , The cooling range is only the tissue that is sucked into the grip and will not affect other surrounding tissues. The uterus is located in the deep layer of the pelvic cavity, with visceral fat and muscles on it, and it will not be affected.

Q7: Will it rebound after finishing treatment?

After treatment, the symptoms of local fat accumulation will not rebound under the premise of controlling the body weight roughly unchanged. It's to make fat tissue undergo apoptosis and phagocytosis under the action of low temperature,

and excrete it from the body through metabolism, and ultimately reduce the number of fat cells in the treatment area and improve the local contour. After treatment, the number of local fat cells will no longer increase, so if you can follow a reasonable diet, choose a healthy lifestyle, and avoid overeating, the volume of remaining fat cells will not increase, so there will be no symptom rebound.

Q8: How long will the effect be seen after treatment?

Usually, significant results can be seen within 2 ~ 3 months after treatment , Because everyone's metabolic rate is different, after about three weeks, the thickness of the fat layer at the treatment site begins to decrease. After 2-3 months, the fat layer at the treatment site becomes thinner, and the relaxation curve will be better.If you want to be more thinner, you can discuss the evaluation with your doctor for the second course of treatment after 3 months. According to the degree of obesity and stubbornness, it can have obvious effect after doing it three to five times.

Q9: Is there any side effects? Does the process hurt?Does it hurt during process therapy?

Generally, there will be some discomfort at the beginning of the treatment, such as a feeling of involvement, coldness, and pain (the degree varies from person to person), but in general, this feeling will soon subside with the numbness of the treatment site.

After treatment, typical side effects include transient flushing, swelling, whitening, bruising, lumps, tingling, tingling, tenderness, spasm, pain, pruritus or skin sensitivity. Rare side effects include delayed pain. But these effects are temporary and usually dissipate in a few days or weeks. In rare cases, other side effects may occur.

Q10: How long can do "waist belly" Diamond ice sculpture after giving birth to a baby?

If there is an incision in the caesarean section, it's recommended to do it after a year; if it's a normal delivery, it can be done in about 3 months, and there are also some stars do it within 28 days You can communicate with your doctor for details.

Q11:What is the difference between diamond ice sculpture/freezing lipolysis and liposuction?

There is still a difference between diamond ice sculpture and liposuction. Generally speaking, liposuction surgery is more suitable for people with a larger weight base and thicker subcutaneous fat, which can lose a lot of fat quickly, but at the same time, the risk is greater and the recovery period is longer. The curative effect of diamond ice sculpture freezing fat reduction is not as fast and intense as invasive procedures such as liposuction. However, for those who are slightly fat, locally fat, and want to avoid the pain of surgery, the risk of

anesthesia, and the waiting time for recovery, using diamond ice sculptures to improve the body line is the most suitable.

Twenty-second、 Technical Parameters

Product name	Diamond ice sculpture slimming machine		
Display screen	15.6 inch large LCD		
Cooling temperature	1-5 gears (cooling temperature 1 to -11 °C)		
Heating temperature	0-4 gears (preheating for 3 minutes, heating temperature 37 to 45 °C)		
Vacuum suction	1-5 gears (10-50Kpa)		
Setting time	1-99min (default 60min)		
Input voltage	110V/220V		
Output Power	1000W		
fuse	15A		
Host size	50(L)×45(W)×107(H)cm		
Air box size	67×53×118.3cm	Air box weight	19kg
Gross weight	67.5kg		