

ZQV

OILFIELD / INDUSTRIAL PRODUCTS



Pls send your enquiries to
sale@cnballvalve.com



BALL VALVES

WWW.GOOBALLVALVES.COM WWW.CNBALLVALVE.COM

ZQV



STAINLESS STEEL BALL VALVES NACE MR0175 ASME B16.34



M2019S SERIES

2000PSI 1-PC MXF BALL VALVE
REDUCED PORT
SIZE: 1/4" - 1/2"



M1021S SERIES

1000PSI 2-PC MXF BALL VALVE
FULL PORT
SIZE: 1/4" - 2"



M2006WSW SERIES

2000PSI 2-PC MXF BALL VALVE
FULL PORT
SIZE: 1/4" - 2"
SEAL WELDED



M3003WSW SERIES

3600PSI 2-PC MXF BALL VALVE
FULL PORT
SIZE: 1/4" - 2"
API 607



1017S SERIES

1000PSI 1-PC BALL VALVE
REDUCED PORT
SIZE: 1/4" - 4"



2018S SERIES

2000PSI 1-PC BALL VALVE
REDUCED PORT
SIZE: 1/4" - 2"
API 607



1021S SERIES

1000PSI 2-PC BALL VALVE
FULL PORT
SIZE: 1/4" - 4"



1031S SERIES

1000PSI 3-PC BALL VALVE
FULL PORT
SIZE: 1/4" - 4"



2006WSW SERIES

2000PSI 2-PC BALL VALVE
FULL PORT
SIZE: 1/4" - 2"
SEAL WELDED



2004WSW SERIES

2000PSI 2-PC BALL VALVE
FULL PORT
SIZE: 1/4" - 2"
SEAL WELDED
API 607



1531S SERIES

2000PSI 3-PC BALL VALVE
REDUCED PORT / FULL PORT
SIZE: 1/4" - 1" 2000WOG
1 1/4" - 2" 1500WOG



1532S SERIES

1500PSI 3-PC BALL VALVE
REDUCED PORT
SIZE: 1/4" - 2"
API 607



3000WSW SERIES

3000PSI 2-PC BALL VALVE
FULL PORT
SIZE: 1/4" - 2"
API 607
SEAL WELDED (OPTION)



6000WSW SERIES

6000PSI 2-PC BALL VALVE
1/4" - 1 1/2" FULL PORT
2" REDUCED PORT
SEAL WELDED
API 607



3003WSW SERIES

3600PSI 2-PC BALL VALVE
FULL PORT
SIZE: 1/4" - 2"
API 607



6003WSW SERIES

6000PSI 2-PC BALL VALVE
FULL PORT
SIZE: 1/4" - 2"
SEAL WELDED
API 607



1022S SERIES

1000PSI 2-PC BALL VALVE
FULL PORT
SIZE: 1/4" - 4"
DIRECT MOUNTING PAD



1032S SERIES

1000PSI 3-PC BALL VALVE
FULL PORT
SIZE: 1/4" - 4"
DIRECT MOUNTING PAD



1023L/T SERIES

1000PSI THREE WAY BALL VALVE
REDUCED PORT
SIZE: 1/4" - 2"
L TYPE & T TYPE



IBV-S SERIES

ISOLATOR BALL VALVE
STANDARD PORT
1" 2000WOG
2" 1500WOG

BALL VALVES

WWW.GOODBALLVALVES.COM WWW.CNBALLVALVE.COM



CARBON STEEL BALL VALVES NACE MR0175 ASME B16.34



2018C SERIES
2000PSI 1-PC BALL VALVE
REDUCED PORT
SIZE: 1/4"-2"
API607



2017C SERIES
2000PSI 1-PC BAR STOCK BALL VALVE
REDUCED PORT
SIZE: 1/4"-2"
LOCKING DEVICE (OPTION)



2027C SERIES
2000PSI 2-PC BAR STOCK BALL VALVE
FULL PORT
SIZE: 1/4"-2"
LOCKING DEVICE (OPTION)



M2019C SERIES
2000PSI 1-PC MXF BALL VALVE
REDUCED PORT
SIZE: 1/4" 1/2"



LM-C SERIES
3000PSI COMPACT FLOATING BALL VALVE
1/4" 1/2" 3/4" FULL PORT
1" REDUCED PORT



1017C SERIES
1000PSI 1-PC BALL VALVE
REDUCED PORT
SIZE: 1/4"-4"



1021C SERIES
1000PSI 2-PC BALL VALVE
FULL PORT
SIZE: 1/4"-4"



1031C SERIES
1000PSI 3-PC BALL VALVE
FULL PORT
SIZE: 1/4"-4"



2006WC SERIES
2000PSI 2-PC BALL VALVE
FULL PORT
SIZE: 1/4"-2"
SEAL WELDED



2004WC SERIES
2000PSI 2-PC BALL VALVE
FULL PORT
SIZE: 1/4"-2"
SEAL WELDED
API607



1531C SERIES
2000PSI 3-PC BALL VALVE
REDUCED PORT / FULL PORT
SIZE: 1/4"-1" 2000WOG
1 1/4"-2" 1500WOG



1532C SERIES
1500PSI 3-PC BALL VALVE
REDUCED PORT
SIZE: 1/4"-2"
API607



3000WC SERIES
3000PSI 2-PC BALL VALVE
FULL PORT
SIZE: 1/4"-2"
API607
SEAL WELDED (OPTION)



6000WC SERIES
6000PSI 2-PC BALL VALVE
1/4"-1 1/2" FULL PORT
2" REDUCED PORT
SEAL WELDED
API607



3003WC SERIES
3600PSI 2-PC BALL VALVE
FULL PORT
SIZE: 1/4"-2"
API607



6003WC SERIES
6000PSI 2-PC BALL VALVE
FULL PORT
SIZE: 1/4"-2"
SEAL WELDED
API607



IBV SERIES
ISOLATOR BALL VALVE
STANDARD PORT
1" 2000WOG
2" 1500WOG



FFBV SERIES
1000PSI MINI BALL VALVE
REDUCED PORT
SIZE: 1/4" - 1"
BODY: CF8 / CF8M



MFBV SERIES
1000PSI MxF MINI BALL VALVE
REDUCED PORT
SIZE: 1/4" - 1"
BODY: CF8 / CF8M



MMBV SERIES
1000PSI MxM MINI BALL VALVE
REDUCED PORT
SIZE: 1/4" - 1"
BODY: CF8 / CF8M

STAINLESS STEEL MINI BALL VALVES

BALL VALVES

WWW.GOODBALLVALVES.COM WWW.CNBALLVALVE.COM



FORGED STEEL BALL VALVES NACE MR0175 ASME B16.34 BS5351, API 608



F2 SERIES

2-PC FORGED BALL VALVE
SIZE: 1/4" - 4" 800LB -2500LB
FULL PORT / REDUCED PORT
A105,LF2,F304,F316
LOCKING DEVICE (OPTION)



F3 SERIES

3-PC FORGED BALL VALVE
SIZE: 1/4" - 4" 800LB -1500LB
FULL PORT / REDUCED PORT
A105,LF2,F304,F316
LOCKING DEVICE (OPTION)



F3R SERIES

3-PC ROUND BALL VALVE
SIZE: 1/4" - 4" 800LB -2500LB
FULL PORT / REDUCED PORT
A105,LF2,F304,F316,F51
LOCKING DEVICE (OPTION)
NPT,SW,BW

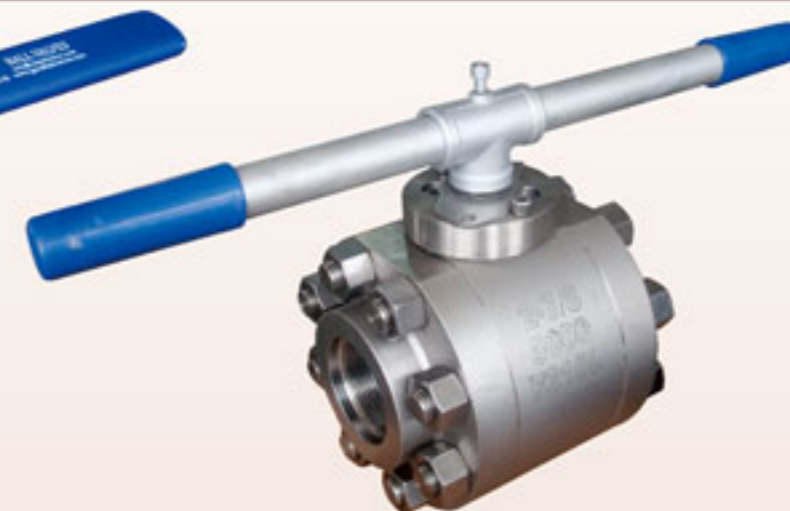

F3E SERIES

EUE OIL FIELD BALL VALVE
SIZE: 2-3/8" 2-7/8" 3000-5000PSI
FULL PORT
A105,LF2,F304,F316
LOCKING DEVICE (OPTION)



T3 SERIES

3-PC FORGED BALL VALVE
1/2" FULL PORT
1" 2" REDUCED PORT
A105,LF2, 3000WOG
LOCKING DEVICE



F2M SERIES

2-PC FORGED BALL VALVE
SIZE: 1/2" - 2" 3000WOG,1500LB
FULL PORT / REDUCED PORT
CARBON STEEL WITH LOCKING
ISO5211 MOUNTING PAD



F3S SERIES

3-PC SQUARE BODY BALL VALVE
SIZE: 1/4" - 4" 800LB -2500LB
2000WOG - 6000WOG
FULL PORT / REDUCED PORT
A105,LF2,F304,F316
LOCKING DEVICE (OPTION)
NPT,SW,BW



KHB SERIES

3-PC HIGH PRESSURE BALL VALVE
1/4" TO 1" 7250PSI
1-1/4" TO 2" 5000PSI
BODY: A105
FULL PORT
SAE THREAD (OPTION)



API 6D & API 6A BALL VALVES NACE MR0175 ASME B16.34



6AT3 SERIES

API 6A FORGED TRUNNION BALL VALVE
RATED WORKING PRESSURE:2000-10000PSI
BORE SIZE: 2-1/16" TO 4-1/16"
TEMPERATURE: K - U
MATERIAL CLASSES: EE - HH
END CONNECTIONS: FLANGE, THREADED
PRODUCT SPECIFICATION LEVEL: PSL1 - PSL4
PERFORMANCE REQUIREMENT: PR1, PR2



WBV SERIES

WAFER BALL VALVE
REDUCED PORT
SIZE:1/2" - 8"
CARBON STEEL/STAINLESS STEEL
PN16,PN25,PN40,150LB,300LB



BVR SERIES

1-PC FLANGED BALL VALVE
REDUCED PORT
SIZE:1/2" - 8"
CARBON STEEL/STAINLESS STEEL
150LB, 300LB



OFBV SERIES

OIL FIELD FLANGED BALL VALVE
FULL PORT
SIZE:2" - 8"
CARBON STEEL/STAINLESS STEEL
150LB,300LB,600LB
NACE MR 0175



VT2 SERIES

FORGED FLOATING BALL VALVE
FULL PORT / REDUCED PORT
A105,LF2,F304,F316, F51
SIZE:1/2" - 10" 150LB - 1500LB



Vt3 SERIES

FORGED TRUNNION BALL VALVE
FULL PORT / REDUCED PORT
A105,LF2,F304,F316,F51
2" - 24" 150LB - 2500LB, RF/ RTJ



BVT SERIES

TRUNNION MOUNTED BALL VALVE
FULL PORT / REDUCED PORT
LCB,WCB,CF8,CF8M,2205
2"- 24" 150LB - 2500LB, RF / RTJ



BVF SERIES

CASTING FLOATING BALL VALVE
FULL PORT / REDUCED PORT
LCB,WCB,CF8,CF8M,2205
1/2" -12" 150LB-600LB, RF / RTJ



OIL FIELD BALL VALVES NACE MR0175 ASME B16.34



GRB SERIES

GROOVED OILFIELD BALL VALVE
REDUCED PORT
SIZE: 2" 3" 4" 750-1000PSI
BODY: A395 DUCTILE IRON
LOCKING HANDLE
NACE MR 0175



DIBV SERIES

1000-2000PSI DI BALL VALVE
FULL PORT: 1" 2" 3" 4"
REDUCED PORT: 2" 3" 4"
BODY: A395 DUCTILE IRON
LOCKING HANDLE
NACE MR 0175



CSBV SERIES

3000-5000PSI CS BALL VALVE
FULL PORT: 1" 2" 3"
REDUCED PORT: 2" 3" 4"
BODY: CS A216 WCB
LOCKING HANDLE
NACE MR 0175



FRB SERIES

FREEZE RESISTANT BALL VALVE
REDUCED PORT: 2" 3" 4"
750PSI-1000PSI
BODY: A395 DUCTILE IRON
LOCKING HANDLE
NACE MR 0175



EUECBV SERIES

EUE END BALL VALVE
FULL PORT: 2-3/8" 2-7/8"
2000PSI, 3600PSI
BODY: CS A216 WCB
LOCKING HANDLE
NACE MR 0175



A2BV SERIES

FORGED OILFIELD BALL VALVE
REDUCED PORT: 2"
BODY: A105
3000PSI, 5000PSI
LOCKING HANDLE
NACE MR 0175



ABBV SERIES

BOLT BODY BALL VALVE
REDUCED PORT: 2"
BODY: A105
3000PSI, 5000PSI
LOCKING HANDLE
NACE MR 0175



CHECK VALVES NACE MR0175 ASME B16.34

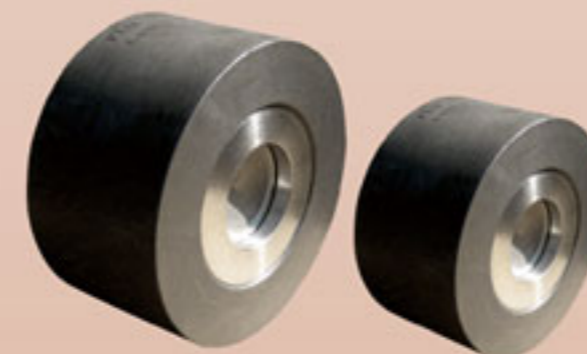

WFCV SERIES

WAFER CHECK VALVE
2" 3" 4" 6"
ANSI CLASS 600 (1480PSI)
FORGED BODY



CVS6000 / CVR3000

3000-6000PSI INLINE CHECK VALVE
BODY: SS316, BRASS, SEAT: BUNA, VITON
SIZE: 1/8" 1/4" 1/2" 3/4" 1"
CRACKING PRESSURE 7-12PSI
NACE MR 0175



DICV SERIES

300-2000PSI DI CHECK VALVE
FULL PORT
SIZE: 1" 2" 3" 4"
BODY: A395 DUCTILE IRON
DISC: CF8/CF8M, SEAT: VITON
NACE MR 0175



CSCV SERIES

3000-5000PSI CS CHECK VALVE
FULL PORT
SIZE: 1" 2" 3"
BODY: CS A216 WCB
DISC: CF8/CF8M, SEAT: VITON
NACE MR 0175



GRDICV SERIES

GROOVED END CHECK VALVE
FULL PORT
SIZE: 2" 3" 300-2000PSI
BODY: A395 DUCTILE IRON
DISC: CF8/CF8M, SEAT: VITON
NACE MR 0175



BDICV SERIES

2000PSI BOLT BODY CHECK VALVE
FULL PORT, BOLT BODY DESIGN
SIZE: 2"
BODY: A395 DUCTILE IRON
DISC: CF8/CF8M, SEAT: VITON
NACE MR 0175



6DCV SERIES

API 6D CHECK VALVE
FULL OPEN
BODY: WCB / WCC, DISC: CF8M, SEAT: VITON
SIZE: 2" 3" 4" 6"
NACE MR 0175



CV SERIES

SWING FLANGED END CHECK VALVE
CARBON STEEL / STAINLESS STEEL
TRIM 1 TO TRIM 16
SIZE: 2" - 24"
150LB - 2500LB, RF/RTJ



DCV SERIES

DUAL-PLATE CHECK VALVE
CARBON STEEL / STAINLESS STEEL
METAL SEAT & SOFT SEAT
2"-24" 150LB - 1500LB



LDCV SERIES

LUG TYPE CHECK VALVE
CARBON STEEL / STAINLESS STEEL
METAL SEAT & SOFT SEAT
2"-24" 150LB - 1500LB



Y STRAINER / BASKET STRAINER



YST SERIES

THREADED END Y STRAINER
WCB/CF8/CF8M
SIZE: 1/4" - 4"
800WOG



YS SERIES

FLANGED END Y STRAINER
WCB/CF8/CF8M/CN7M
SIZE: 1/2" - 24"
150LB - 1500LB
BOLTED COVER, PLUGGED BLOW-OFF



YSCI SERIES

CI FLANGED Y STRAINER
CAST IRON A126 GR. B
ANSI CLASS 125LB
BOLTED COVER, PLUGGED BLOW-OFF



BSF SERIES

BASKET STRAINER
WCB/CF8/CF8M
ANSI CLASS 150LB, 300LB
BOLTED COVER

FORGED CHECK VALVE

CVW800 SERIES

SWING CHECK VALVE
SIZE: 1/2" - 2" 800LB
REDUCED PORT
BODY: A105, TIRM: ASTM 410
API602/API598



CVL800 SERIES

LIFT CHECK VALVE
SIZE: 1/2" - 2" 800LB
REDUCED PORT
BODY: A105, TIRM: ASTM 410
API602/API598



YS800 SERIES

Y STRAINER
SIZE: 1/2" - 2" 800LB
SCREEN: 304SS
BODY: A105, F304, F316
API602/API598



FORGED GATE/GLOBE VALVE



GV800 SERIES

GATE VALVE
SIZE: 1/2" - 2" 800LB
REDUCED PORT
BODY: A105, TIRM: ASTM 410
API602/API598



GL800 SERIES

GLOBE VALVE
SIZE: 1/2" - 2" 800LB
REDUCED PORT
BODY: A105, TIRM: ASTM 410
API602/API598

BUTTERFLY VALVE API 609/API 598



WVA SERIES

ALIGNMENT BUTTERFLY VALVE
SIZE: 2" - 12"
BODY A395 DUCTILE IRON
SEAT: BUNA / VITON / EPDM
DISC: 316SS / DI



WVL SERIES

LUG BUTTERFLY VALVE
SIZE: 2" - 12"
BODY A395 DUCTILE IRON
SEAT: BUNA / VITON / EPDM
DISC: 316SS / DI



WVV SERIES

WAFER BUTTERFLY VALVE
SIZE: 2" - 12"
BODY A395 DUCTILE IRON
SEAT: BUNA / VITON / EPDM
DISC: 316SS / DI

NEEDLE VALVE



QSPV/QCPV SERIES

6000PSI-10000PSI NEEDLE VALVE
6000PSI@200F SOFT SEAT
10000PSI@200F METAL SEAT
316SS & CARBON STEEL
SIZE: 1/4" 1/2" 3/4" 1" MxF, FxF



QSNA/QCNA SERIES

ANGLE NEEDLE VALVE
6000PSI@200F SOFT SEAT
10000PSI@200F METAL SEAT
316SS & CARBON STEEL
SIZE: 1/4" 1/2" MxF



QSMPV/QCMPV SERIES

MULTI-PORT NEEDLE VALVE
6000PSI@200F SOFT SEAT
10000PSI@200F METAL SEAT
316SS & CARBON STEEL
SIZE: 1/2" 3/4" 1" MxF, FxF



QVBB SERIES

2 VALVE BLOCK & BLEED MANIFOLD
6000PSI@200F SOFT SEAT
316SS & CARBON STEEL
SIZE: 1/4" 1/2" 3/4" 1" MxF, FxF

CAST STEEL CHECK VALVE & GATE VALVE & GLOBE VALVE API 6D / API 600 / BS1868



INDUSTRIAL CHECK VALVE SERIES

BS1868 & BS1873 & API 6D & API 600 CHECK VALVE
FULL OPEN
SIZE: 2" TO 24"
CLASS: 150LB TO 2500LB
END: RF, RTJ, BW ENDS
SWING TYPE

GATE VALVE & GLOBE VALVE SERIES

API 600 & API 6D & ASME B 16.34
OS & Y, OUTSIDE SCREW AND YOKE
BB, BOLTED BONNET
FLEXILE WEDGE, FULLY GUIDED
SIZE: 2" TO 42"
TIRM: 1# TO 16#
CLASS: 150LB TO 2500LB
FLANGED, RF, RTJ, BW ENDS



GROOVED END CHECK VALVES & BALL VALVES

GRSSCV SERIES

GROOVED END CHECK VALVE
FULL PORT
SIZE: 2" 2000PSI
BODY: A351 CF8M
DISC: CF8M, SEAT: PTFE / VITON
NACE MR 0175



GRDICV SERIES

GROOVED END CHECK VALVE
FULL PORT
SIZE: 2" 3" 300-2000PSI
BODY: A395 DUCTILE IRON
DISC: CF8/CF8M, SEAT: VITON
NACE MR 0175



GRBDI SERIES

1000PSI CS GROOVED BALL VALVE
REDUCED PORT
SIZE: 2" 3" 4"
BODY: A395 DUCTILE IRON
BALL: CF8 / CF8M
NACE MR0175



GRBSS SERIES

1000PSI BOLT BODY GROOVED BALL VALVE
FULL PORT
SIZE: 3" 4"
BODY: A351 CF8M
BALL: CF8M



GRB SERIES

GROOVED OILFIELD BALL VALVE
REDUCED PORT
SIZE: 2" 3" 4" 750-1000PSI
BODY A395 DUCTILE IRON
LOCKING HANDLE
NACE MR 0175

EUE 8R CHECK VALVES / EUE 8R BALL VALVE



EUESCV SERIES

3000PSI EUE CHECK VALVE
FULL OPEN, SIZE: 2-7/8"
BODY: CF8M, DISC: CF8M, SEAT: VITON
NACE MR 0175

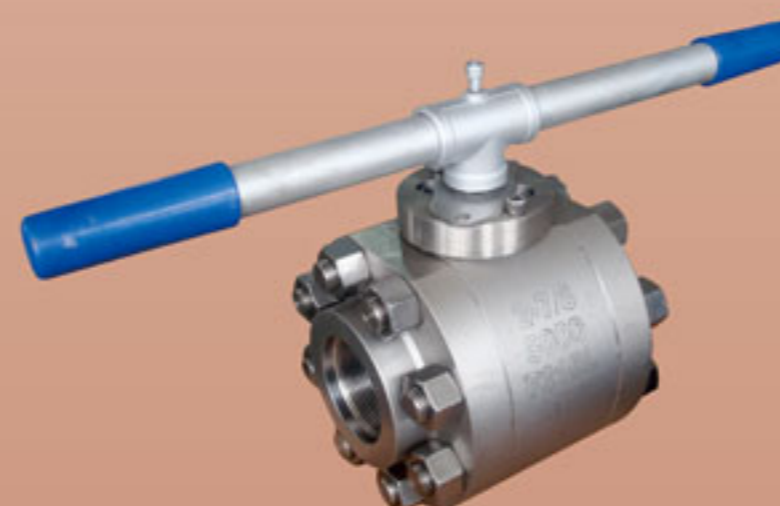

F3E SERIES

EUE OIL FIELD BALL VALVE
SIZE: 2-3/8" 2-7/8" 3000-5000PSI
FULL PORT
A105, LF2, F304, F316
LOCKING DEVICE (OPTION)



EUECBV SERIES

EUE 8R BALL VALVE
FULL PORT: 2-3/8" 2-7/8"
2000PSI, 3600PSI
BODY: CS A216 WCB
LOCKING HANDLE
NACE MR 0175

API 6A GATE VALVE

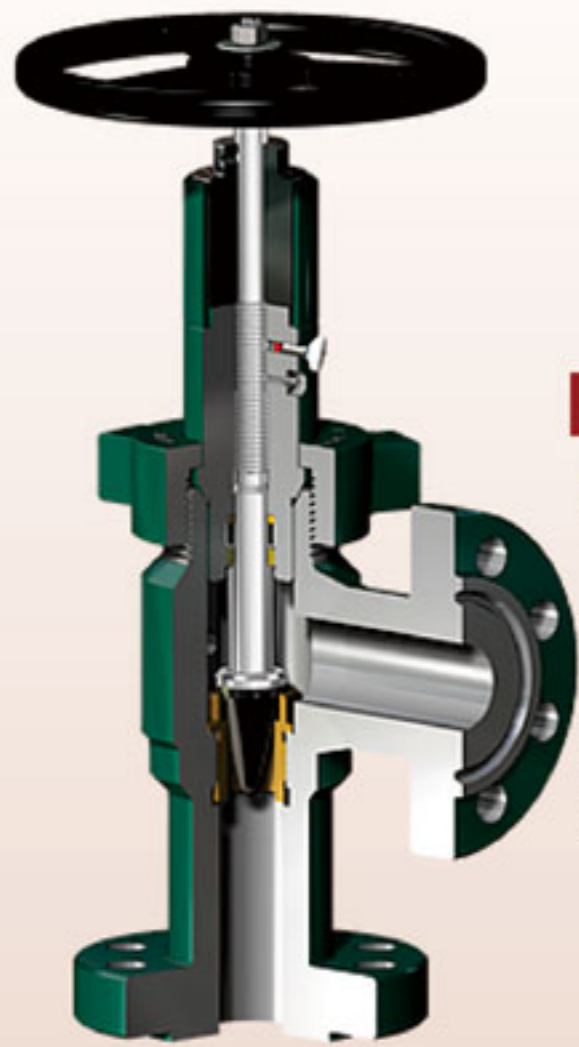

ACV SERIES

ADJUSTABLE CHOKE VALVE
 RATED WORKING PRESSURE:
 CAST BODY: 2000-5000PSI
 FORGED BODY: 2000-15000PSI
 BORE SIZE: 2-1/16" TO 4-1/16"
 TEMPERATURE: K ~ U
 MATERIAL CLASSES: EE ~ HH
 END CONNECTIONS: FLANGE, THREADED
 PRODUCT SPECIFICATION LEVEL: PSL1 ~ PSL4
 PERFORMANCE REQUIREMENT: PR1, PR2

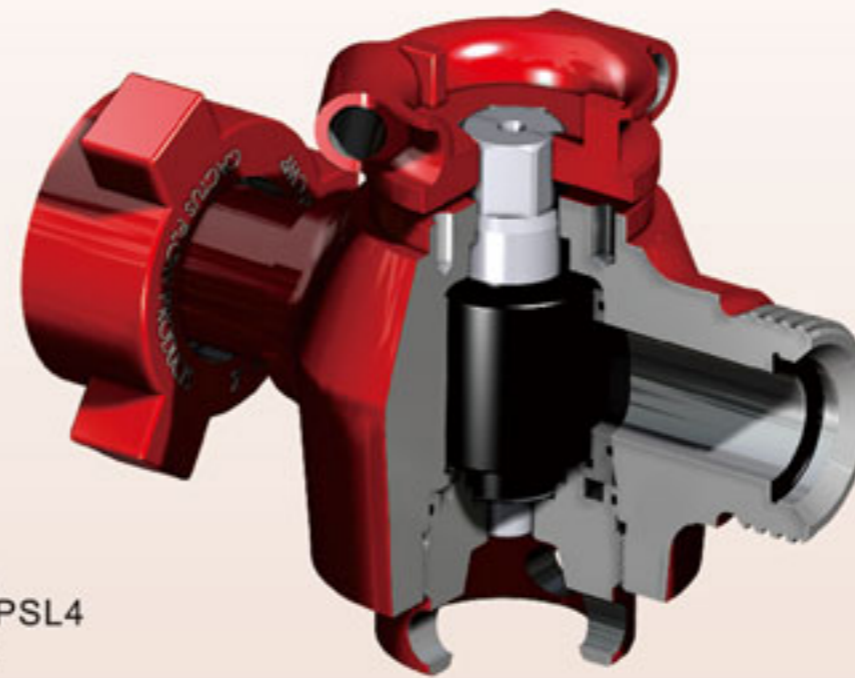

6APV SERIES

PLUG VALVE
 RATED WORKING PRESSURE: 2000-15000PSI
 BORE SIZE: 1" TO 4"
 TEMPERATURE: K ~ U
 MATERIAL CLASSES: EE ~ HH
 PRODUCT SPECIFICATION LEVEL: PSL1 ~ PSL4
 PERFORMANCE REQUIREMENT: PR1, PR2



6AT3 SERIES

API 6A FORGED TRUNNION BALL VALVE
 RATED WORKING PRESSURE: 2000-10000PSI
 BORE SIZE: 2-1/16" TO 4-1/16"
 TEMPERATURE: K ~ U
 MATERIAL CLASSES: EE ~ HH
 END CONNECTIONS: FLANGE, THREADED
 PRODUCT SPECIFICATION LEVEL: PSL1 ~ PSL4
 PERFORMANCE REQUIREMENT: PR1, PR2



FC SERIES / M SERIES

SLAB GATE VALVE / EXPANDING GATE VALVE
 RATED WORKING PRESSURE:
 CAST BODY: 2000-5000PSI
 FORGED BODY: 2000-15000PSI
 BORE SIZE: 2-1/16" TO 4-1/16"
 TEMPERATURE: K ~ U
 MATERIAL CLASSES: EE ~ HH
 END CONNECTIONS: FLANGE, THREADED
 PRODUCT SPECIFICATION LEVEL: PSL1 ~ PSL4
 PERFORMANCE REQUIREMENT: PR1, PR2



HAMMER UNIONS

DUCTILE IRON CASTING
 1000PSI TO 15000PSI
 SIZE: 1" TO 8"



FIGURE 100 T x T



FIGURE 200 & 206 T x T



FIGURE 602 T x T



FIGURE 400 T x T



FIGURE 602 BW



FIGURE 102 T x T



FIGURE 102 BW



FIGURE 1502 T x T



FIGURE 1502 BW

OIL COUNTRY FITTINGS

SWAGES & BULL PLUGS
STD&XH&XXH
ELECTRO ZINC PLATED
MSS-SP-95
SIZE: 2 3/8" TO 5 1/2" API 2" TO 3" LP



PIPE NIPPLES

CARBON STEEL A106
STAINLESS STEEL 316SS
STD&XH&XXH
SIZE: 2" - 12"



SWAGE NIPPLE

CARBON STEEL A105
STAINLESS STEEL
STD&XH&XXH
ELECTRO ZINC PLATED
MSS-SP-95
SIZE: 1/2" - 4"



BULL PLUG

CARBON STEEL A105
STAINLESS STEEL 316SS
STD&XH&XXH
ELECTRO ZINC PLATED
MSS-SP-95
SIZE: 1/2" - 4"



THERMOWELLS

STAINLESS STEEL
304SS & 316SS
SIZE: 1/4" 1/2" 3/4"
LENGTH: 2" 2 1/2" 4"
6" & 8"

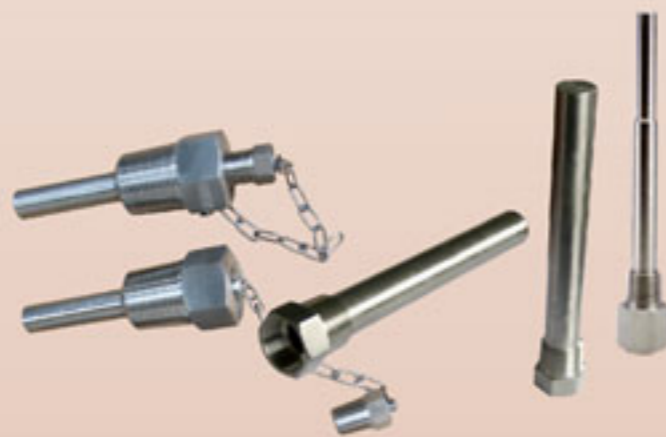

SPIRAL WOUND GASKETS

CLASS 150, 300, 600
304SS/316SS GRAPHITE FILLER
SIZE: 1/2" - 24"



GREASE FITTINGS & DRAIN VALVE

CARBON STEEL, STAINLESS STEEL
BODY: A105, 304SS, 316SS
SIZE: 1/4" 1/2"



RING JOINT GASKETS

STAINLESS STEEL
CARBON STEEL
TYPE: R, RX & BX
SIZE: 1/2" - 36"



FORGED STEEL FITTINGS ASME B16.11

FORGED STEEL
2000, 3000, 6000LBS
THREADED & SOCKET WELD
ASME B16.11 MSS-SP-83
SIZE: 1/8" TO 4"



HEX HEAD PLUG

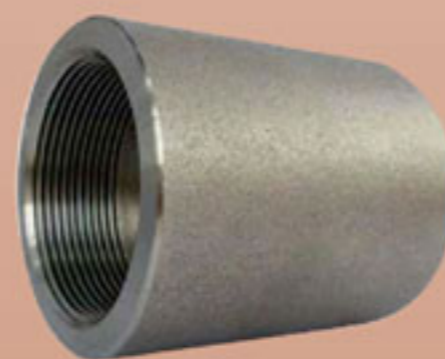

GOUPLING



TEE



CROSS



OUTLET

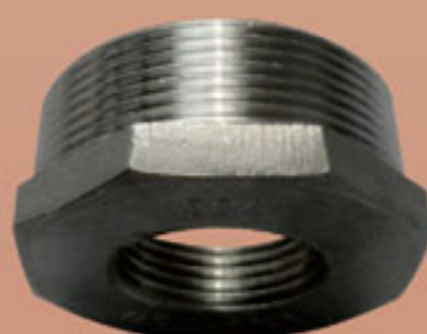

HEX BUSHING



45° ELBOW



90° ELBOW



UNION

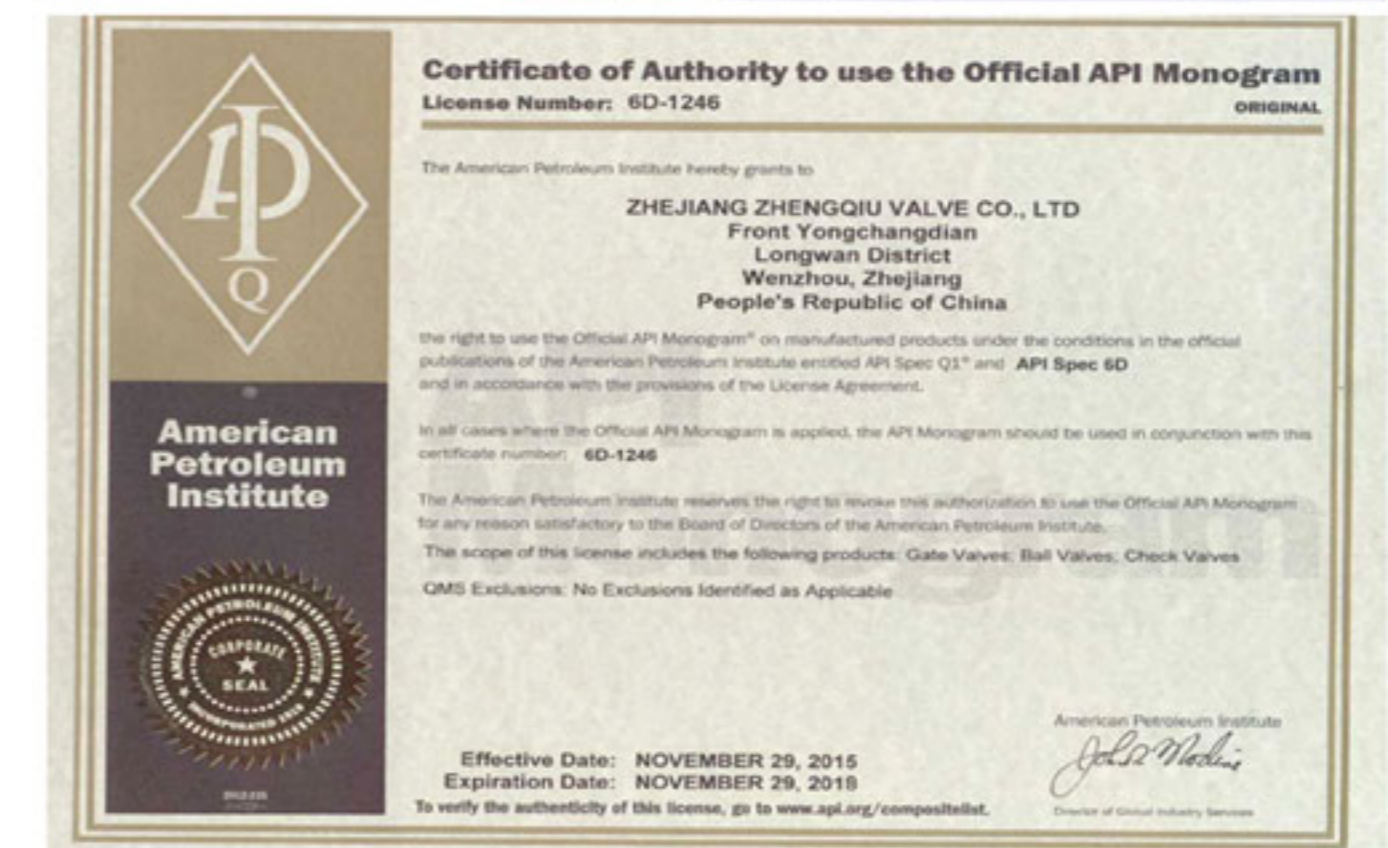

**BEST QUALITY
BEST SERVICE
COMPETITIVE PRICE
TIMELY DELIVERY**

ZQV

ZHEJIANG ZHENGQIU VALVE CO.,LTD

Add: High and new industrial zone, Yongzhong
Wenzhou, Zhejiang, China, Pn:325024



 Tel: 0086-577-86911288

 Fax: 0086-577-86911558

 [Http://www.cnballvalve.com](http://www.cnballvalve.com) www.goodballvalves.com

E-mail: sale@cnballvalve.com