



无磁轨直线电机
MTF-LM

无磁轨直线电机及其模组 产品手册

MAGNETIC-TRACK- FREELINEAR
MOTORS AND ITS MODULES DATASHEET

探索尖端科技, 服务客户, 超越自我。

EXPLORING CUTTING-EDGE TECHNOLOGY, SERVING CUSTOMERS, GOING BEYOND OURSELVES.

真诚 善行 奋进 求索
GOOD FAITH BENEFACTION ENTERPRISING DISCOVERY



ALM Intelligent Technology (Suzhou) Co., Limited

E-mail: sales@seidal-tec.com

Web: www.seidal-tec.com

Tel: +86 18962406535

Add: No 1998 Jinfeng south road, Wuzhong district, Suzhou, China



ALM Intelligent Technology (Suzhou) Co., Limited

Version 5.0

HONOR QUALIFICATION

SEIDAL has obtained more than ten patents, and been awarded the 'Leading talent start-up for innovation in Wuzhong district', the 'Leading talent start-up for innovation in Suzhou', the 'Excellent technology company in WuzhongGaoxin district' and the 'Technology-based civilian-run enterprise in Jiangsu Province'.



ENTERPRISE CULTURE 企业文化

GOOD FAITH /
BENEFACATION /
ENTERPRISING /
DISCOVERY /

真诚 善行 奋进 求索



HONOR AND QUALIFICATION

WHAT IS MAGNETIC-TRACK-FREE[®] LINEAR MOTOR (MTF-LM)

ABOUT MTF-LM

Linear motor moves by the magnetic force produced by the magnetic field between stator and mover, so the mover and the stator are untouched. For the conventional linear motors, whether for the iron core or the ironless core linear motors, they need to lay the magnetic track built by the permanent magnets on the stator, so the motor can move by the magnetic force produced by the coil-generated magnetic field and the PM generated magnetic field.

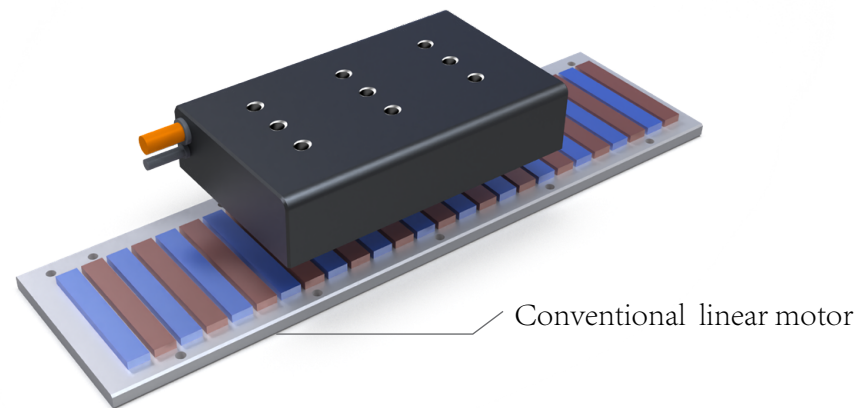

We proposed the Magnetic-track-free (MTF) linear motor for the first time in industry based on the innovation in the magnetic field theory. Remarkably, the stator does not need the PMs anymore, which can save the massive rare-earth materials. By iteratively optimizing the design and the manufacturing craft, MTF linear motor obtained the extremely high force density, operating speed and moving precision.

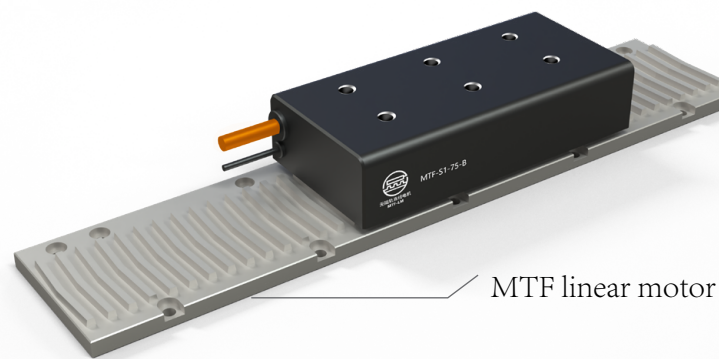

ADVANTAGES OF MTF LINEAR MOTORS

Besides the high speed and precision merits as the conventional linear motor, MTF-LM has the following advantages.

MORE SAFE

No magnetic field in stator, easier for assembling, much lower risk for operators

MUCH SMALLER ATTRACTION FORCE

About 1/3 of the conventional linear motor attraction force can reduce the friction and cogging force significantly, thus to increase the life expectancy and reduce the operating noise.

MUCH SMALLER COGGING FORCE

Benefited from the low attraction force and the specialized optimizing design, MTF-LM can obtain the extremely low cogging force.

MORE ADAPTIVE

With low requirement for the ingress protection, and reduce the EMI grade obviously

EASIER FOR PROTECTION

Not easy to attract the sundries and ashes into the motor, easier for protection

HIGHER COST-EFFECTIVE

Benefited from the rare-earth material saving, MTF is trying to provide the most cost-effective products for customers.

The applications of MTF linear motors in the following area can bring significant advantages for our customers.

Ic Package	Testing Of Semiconductor Equipments	Ic Patching	Photovoltaic Panel Manufacture	Lithium Battery Manufacture
Laser Cutting Equipments	Medical Apparatus And Instruments	Machine Tools	Optical Equipments	Display Panel Manufacture

SEIDAL'S MTF-LM

MAGNETIC TRACK-FREE LINEAR MOTOR

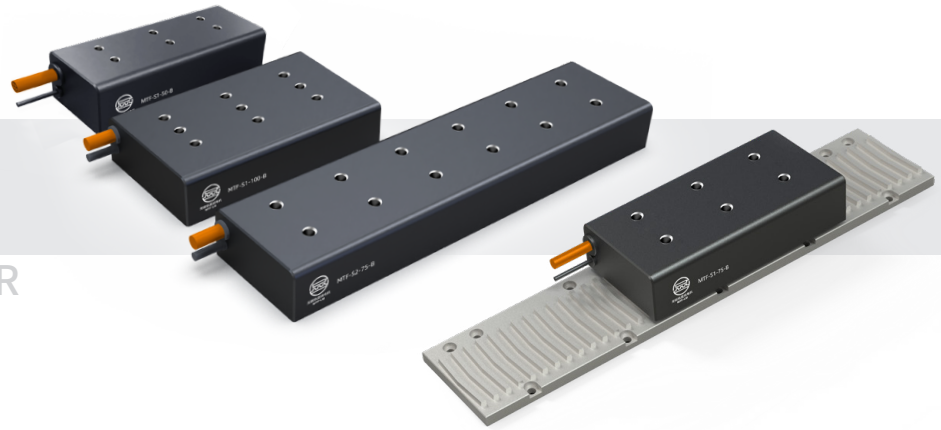

(MTF- LM)

MTF LINEAR MOTORS

Series	Feature	Performance	Applications
 S1	<ul style="list-style-type: none"> The use of non-magnetic rail sergs, affordable No magnetic field on the synth, safe, easy to protect compact structure, Light, small inertia Very low tooth groove force and electro-magnetic thrust fluctuations significantly reduce the vertical suction force (About 1/3 of conventional motors) 	<ul style="list-style-type: none"> Up to 14G acceleration up to 26m/s speed thrust range from 63N-325N 	<ul style="list-style-type: none"> Wafer detection Patch machine Crystal-fixing machine Welding wire machine PCB punching / testing Three-coordinate measurement Medical devices Universal automation
 S2	<ul style="list-style-type: none"> The use of non-magnetic rail sergs, affordable No magnetic field on the synth, safe and easy to protect The length of the mover is moderate Medium weight linear motor Very low tooth groove force and electromagnetichrust fluctuations Significantly reduce the vertical suction force (About 1/3 of conventional motors) 	<ul style="list-style-type: none"> Up to 14G acceleration up to 26m/s speed thrust range from 63N-325N 	<ul style="list-style-type: none"> Crystal-fixing machine Welding wire machine PCB punching / testing The seventh axis of the robot Medical devices The up-and-down system Universal automation

FAST SELECTION CONTENT OF MTF LINEAR MOTORS

Series	Motor	Continue Current	DC Bus Voltage	Maximum speed at rated force	Continue/Peak force						Mover width	Mover length	Motor height
					50	100	200	400	800	1600			
S1	MTF- S1- 50- A	1.5A	310V	5.4m/s	62N/160N						50mm	156mm	45mm
			510V	8.9m/s									
	MTF- S1- 50- B	3.0A	310V	10.8m/s	153N/346N						75mm		
			510V	17.8m/s									
	MTF- S1- 75- A	3.0A	310V	4.8m/s	246N/479N						90mm		
			510V	7.9m/s									
	MTF- S1- 75- B	6.0A	310V	9.6m/s	276N/538N						100mm		
	510V		15.8m/s										
MTF- S1- 90- A	4.5A	310V	5.4m/s	124N/320N						50mm			
		510V	8.7m/s										
MTF- S1- 90- B	9.0A	310V	10.8m/s	306N/692N						75mm			
		510V	17.4m/s										
MTF- S1- 100- A	4.5A	310V	4.6m/s	492N/958N						90mm			
		510V	7.6m/s										
MTF- S1- 100- B	9.0A	310V	9.2m/s	552N/1076N						100mm			
		510V	15.2m/s										
S2	MTF- S2- 50- A	1.5A	310V	2.7m/s	124N/320N						50mm	300mm	
			510V	4.4m/s									
	MTF- S2- 50- B	3.0A	310V	5.4m/s	306N/692N						75mm		
			510V	8.8m/s									
	MTF- S2- 75- A	3.0A	310V	2.4m/s	492N/958N						90mm		
			510V	3.9m/s									
	MTF- S2- 75- B	6.0A	310V	4.8m/s	552N/1076N						100mm		
	510V		7.8m/s										
MTF- S2- 90- A	4.5A	310V	2.7m/s	552N/1076N						100mm			
		510V	4.3m/s										
MTF- S2- 90- B	9.0A	310V	5.4m/s	552N/1076N						100mm			
		510V	8.6m/s										
MTF- S2- 100- A	4.5A	310V	2.3m/s	552N/1076N						100mm			
		510V	3.8m/s										
MTF- S2- 100- B	9.0A	310V	4.6m/s	552N/1076N						100mm			
		510V	7.6m/s										

MTF- S1- 50- A(B)



PERFORMANCE PARAMETERS

		MTF- S1- 50- A	MTF- S1- 50- B
Continue Force	N	62	62
Peak Force	N	160	160
Continue Current (RMS)	A	1.5	3.0
Peak Current (RMS)	A	6.0	12.0
Resistance(25°C) (L-L)	Ohm	3.2	0.8
Inductance (L-L)	mH	33.0	8.3
Maximum Speed at Continue Force力	DC310V	5.4	10.8
	DC510V	8.9	17.8
Force Constant	N/A(RMS)	41.3	20.7
Back-EMF Constant (L-L)	V _{Peak} /(m/s)	38.5	19.3
Magnetic Period	mm	9.0	9.0
Attraction Force	N	680	680
Maximum Coil Temperature	°C	120	120
Thermal Sensor	PTC 3K Ohm		
Motor Constant	N/sqrt(W)	18.9	18.9
Electrical Time Constant	ms	10.3	10.3
Heat Dissipation Constant	W/°C	0.6	0.6
Mechanical Gap	mm	0.5	0.5
Mover Weight	kg	1.1	1.1

Note: The data was obtained at the 20 °C ambient temperature, and the continuous current test is based on one carriage with 12mm thick and same length, 2 time of width of the mover.

- Any use of the motor beyond speed/force limit to motor damage and serious injuries. To ensure safe, customers should use the motor in the limited range. cannot be held responsible if the motor is used in an improper way.

Applicable Stators

Model	length(mm)	Width(mm)	Height(mm)	Weight(kg)	Mounting Holes
MTF-T9-50-72	72.0	50.0	10.2	0.19	Φ10.0 ± 3.0 Φ6.0 THRU
MTF-T9-50-144	144.0	50.0	10.2	0.38	
MTF-T9-50-360	360.0	50.0	10.2	0.95	

Mounting of Stators

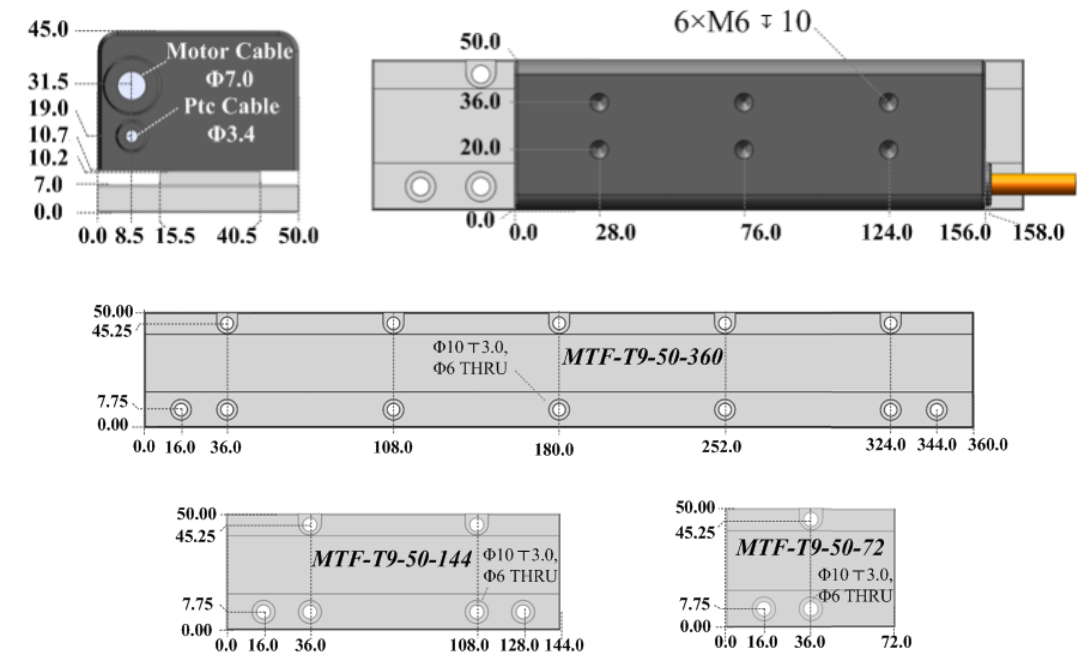

Curve of Force and Speed

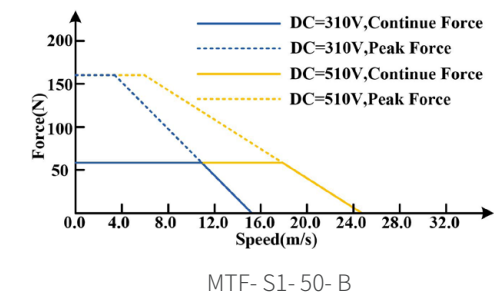
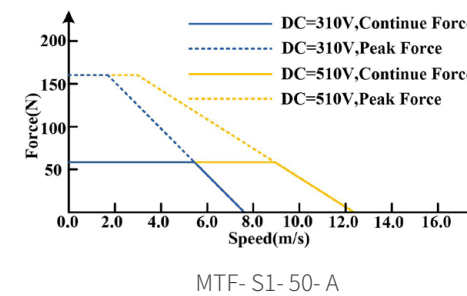

MTF- S1- 75- A(B)

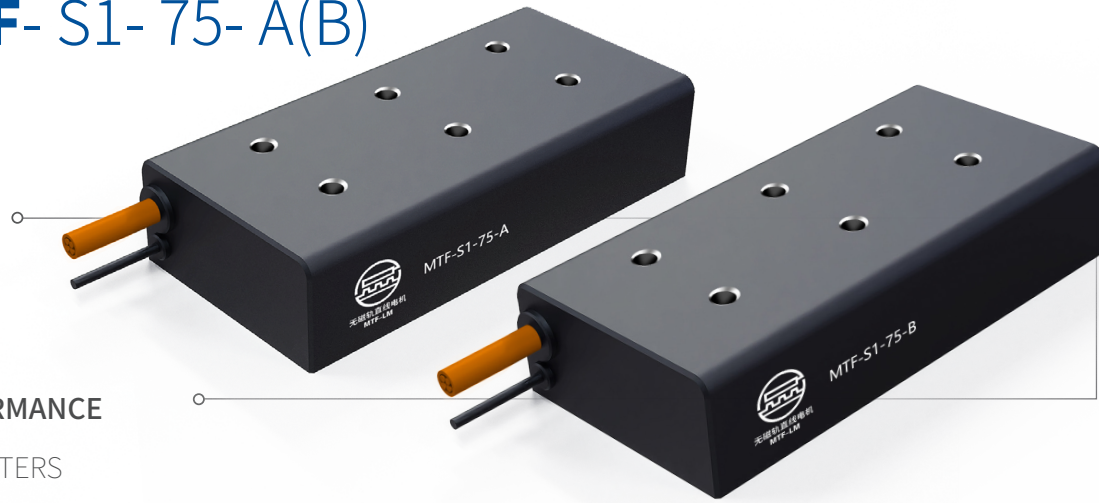

PERFORMANCE

PARAMETERS

		MTF- S1- 75- A	MTF- S1- 75- B
Continue Force	N	153	153
Peak Force	N	346	346
Continue Current (RMS)	A	3.0	6.0
Peak Current (RMS)	A	12.0	24.0
Resistance(25°C) (L-L)	Ohm	1.6	0.4
Inductance (L-L)	mH	18.5	4.6
Maximum Speed at Continue	DC310V DC510V	4.8 7.9	9.6 15.8
Force Constant	N/A(RMS)	51.0	25.5
Back-EMF Constant (L-L)	V _{Peak} /(m/s)	44.0	22.0
Magnetic Period	mm	9.0	9.0
Attraction Force	N	1370	1370
Maximum Coil Temperature	°C	120	120
Thermal Sensor	PTC 3K Ohm		
Motor Constant	N/sqrt(W)	32.9	32.9
Electrical Time Constant	ms	11.6	11.6
Heat Dissipation Constant	W/°C	0.8	0.8
Mechanical Gap	mm	0.5	0.5
Mover Weight	kg	1.9	1.9

Note: The data was obtained at the 20 °C ambient temperature, and the continuous current test is based on one carriage with 12mm thick and same length, 2 time of width of the mover.

- Any use of the motor beyond speed/force limit to motor damage and serious injuries. To ensure safe, customers should use the motor in the limited range. cannot be held responsible if the motor is used in an improper way.

Applicable Stators

Model	length(mm)	Width(mm)	Height(mm)	Weight(kg)	Mounting Holes
MTF-T9-75-72	72.0	75.0	10.2	0.29	Φ10.0 ± 3.0 Φ6.0 THRU
MTF-T9-75-144	144.0	75.0	10.2	0.58	
MTF-T9-75-360	360.0	75.0	10.2	1.45	

Mounting of Stators

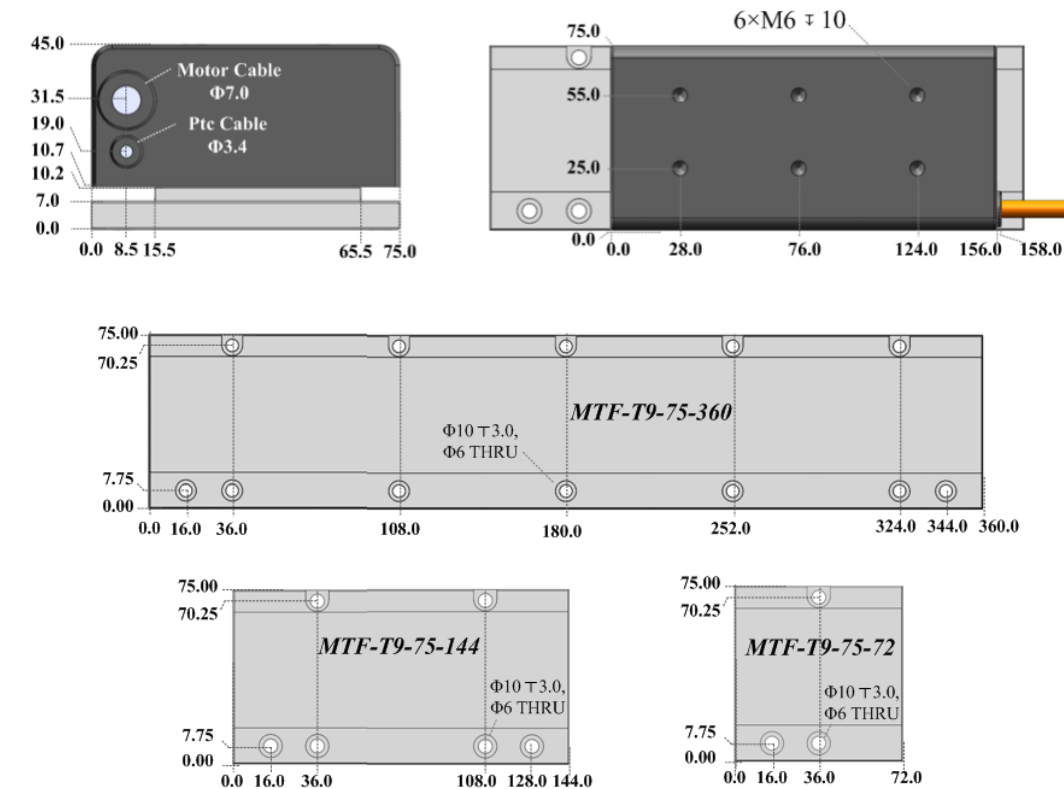

Curve of Force and Speed

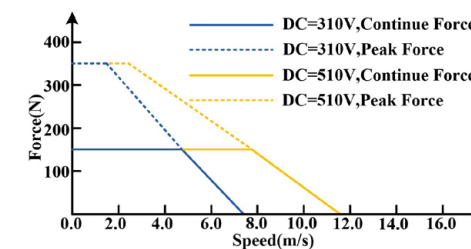

MTF- S1- 75- A

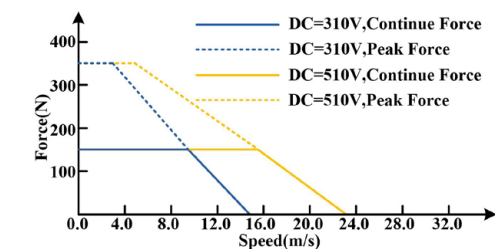

MTF- S1- 75- B

MTF- S1- 90- A(B)



PERFORMANCE

PARAMETERS

		MTF-S1-90-A	MTF-S1-90-B
Continue Force	N	246	246
Peak Force	N	479	479
Continue Current (RMS)	A	4.5	9.0
Peak Current (RMS)	A	18.0	36.0
Resistance(25°C) (L-L)	Ohm	0.9	0.2
Inductance (L-L)	mH	10.1	2.5
Maximum Speed at Continue Force	DC310V	5.4	10.8
	DC510V	8.7	17.4
Force Constant	N/(RMS)	54.7	24.3
Back-EMF Constant (L-L)	V _{Peak} /(m/s)	43.8	21.9
Magnetic Period	mm	9.0	9.0
Attraction Force	N	1720	1720
Maximum Coil Temperature	°C	120	120
Thermal Sensor	PTC 3K Ohm		
Motor Constant	N/sqrt(W)	47.6	47.6
Electrical Time Constant	ms	11.5	11.5
Heat Dissipation Constant	W/°C	1.2	1.2
Mechanical Gap	mm	0.5	0.5
Mover Weight	kg	2.3	2.3

Note: The data was obtained at the 20 °C ambient temperature, and the continuous current test is based on one carriage with 12mm thick and same length, 2 time of width of the mover.

- Any use of the motor beyond speed/force limit to motor damage and serious injuries. To ensure safe, customers should use the motor in the limited range. cannot be held responsible if the motor is used in an improper way.

Applicable Stators

Model	length(mm)	Width(mm)	Height(mm)	Weight(kg)	Mounting Holes
MTF-T9-90-72	72.0	90.0	10.2	0.36	Φ10.0 ± 3.0 Φ6.0 THRU
MTF-T9-90-144	144.0	90.0	10.2	0.72	
MTF-T9-90-360	360.0	90.0	10.2	1.8	

Mounting of Stators

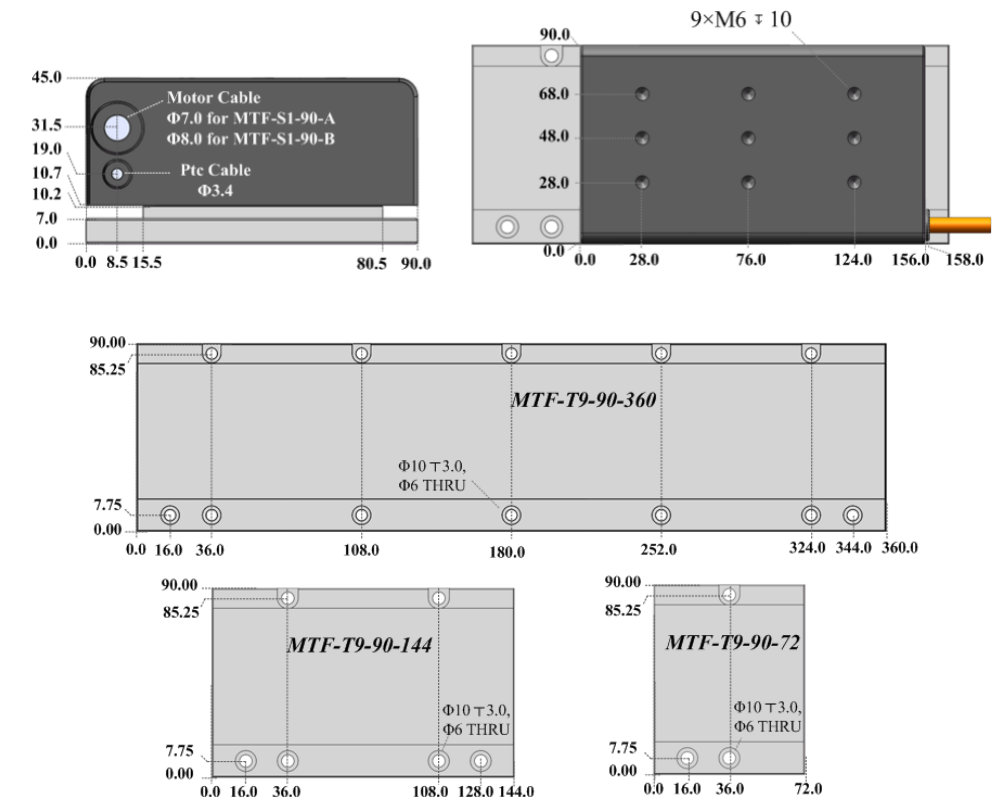

Curve of Force and Speed

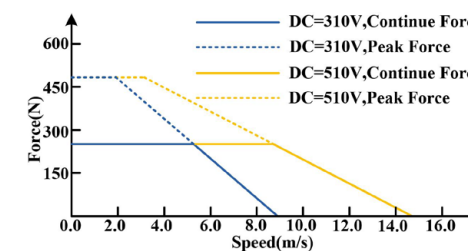

MTF- S1- 90- A

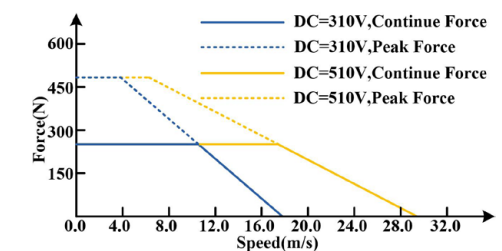

MTF- S1- 90- B

MTF- S1- 100- A(B)



PERFORMANCE

PARAMETERS

		MTF-S1-100-A	MTF-S1-100-B
Continue Force	N	276	276
Peak Force	N	538	538
Continue Current (RMS)	A	4.5	9.0
Peak Current (RMS)	A	18.0	36.0
Resistance(25°C) (L-L)	Ohm	1.0	0.3
Inductance (L-L)	mH	11.8	3.0
Maximum Speed at Continue	DC310V	4.6	9.2
	DC510V	7.6	15.2
Force Constant	N/A(RMS)	61.3	30.7
Back-EMF Constant (L-L)	V _{Peak} /(m/s)	49.8	24.9
Magnetic Period	mm	9.0	9.0
Attraction Force	N	1950	1950
Maximum Coil Temperature	°C	120	120
Thermal Sensor	PTC 3K Ohm		
Motor Constant	N/sqrt(W)	50.1	50.1
Electrical Time Constant	ms	11.8	11.8
Heat Dissipation Constant	W/°C	1.3	1.3
Mechanical Gap	mm	0.5	0.5
Mover Weight	kg	2.6	2.6

Note: The data was obtained at the 20 °C ambient temperature, and the continuous current test is based on one carriage with 12mm thick and same length, 2 time of width of the mover.

- Any use of the motor beyond speed/force limit to motor damage and serious injuries. To ensure safe, customers should use the motor in the limited range. cannot be held responsible if the motor is used in an improper way.

Applicable Stators

Model	length(mm)	Width(mm)	Height(mm)	Weight(kg)	Mounting Holes
MTF-T9-100-72	72.0	100.0	10.2	0.4	Φ10.0 ± 3.0 Φ6.0 THRU
MTF-T9-100-144	144.0	100.0	10.2	0.8	
MTF-T9-100-360	360.0	100.0	10.2	2.0	

Mounting of Stators

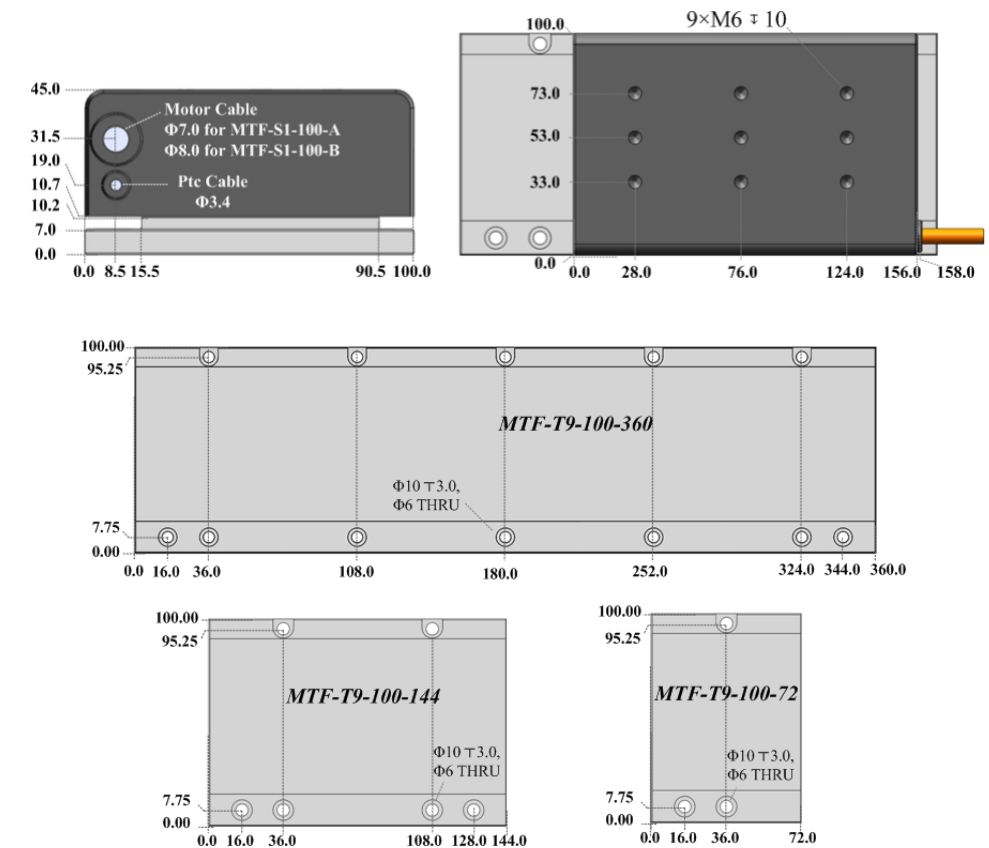

Curve of Force and Speed

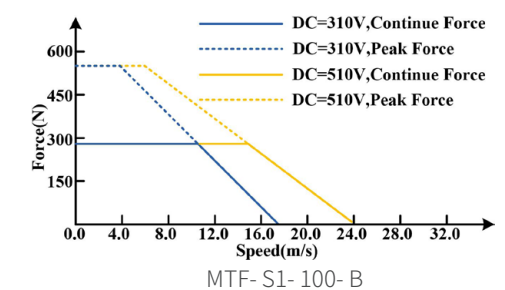
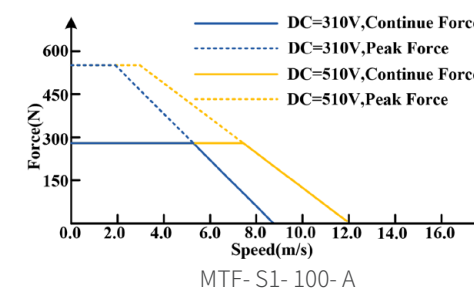

MTF- S2- 50- A(B)



PERFORMANCE

PARAMETERS

		MTF-S2-50-A	MTF-S2-50-B
Continue Force	N	124	124
Peak Force	N	320	320
Continue Current (RMS)	A	1.5	3.0
Peak Current (RMS)	A	6.0	12.0
Resistance(25°C) (L-L)	Ohm	6.4	1.6
Inductance (L-L)	mH	66.0	16.5
Maximum Speed at Continue	DC310V DC510V	2.7 4.4	5.4 8.8
Force Constant	N/A(RMS)	82.7	41.3
Back-EMF Constant (L-L)	V _{Peak} /(m/s)	77.0	38.5
Magnetic Period	mm	9.0	9.0
Attraction Force	N	1360	1360
Maximum Coil Temperature	°C	120	120
Thermal Sensor	PTC 3K Ohm		
Motor Constant	N/sqrt(W)	26.7	26.7
Electrical Time Constant	ms	10.3	10.3
Heat Dissipation Constant	W/°C	1.2	1.2
Mechanical Gap	mm	0.5	0.5
Mover Weight	kg	2.1	2.1

Note: The data was obtained at the 20 °C ambient temperature, and the continuous current test is based on one carriage with 12mm thick and same length, 2 time of width of the mover.
 Any use of the motor beyond speed/force limit to motor damage and serious injuries. To ensure safe, customers should use the motor in the limited range. cannot be held responsible if the motor is used in an improper way.

Applicable Stators

Model	length(mm)	Width(mm)	Height(mm)	Mass(kg)	Mounting Holes
MTF-T9-50-72	72.0	50.0	10.2	0.19	Φ10.0 ± 3.0 Φ6.0 THRU
MTF-T9-50-144	144.0	50.0	10.2	0.38	
MTF-T9-50-360	360.0	50.0	10.2	0.95	

Mounting of Stators

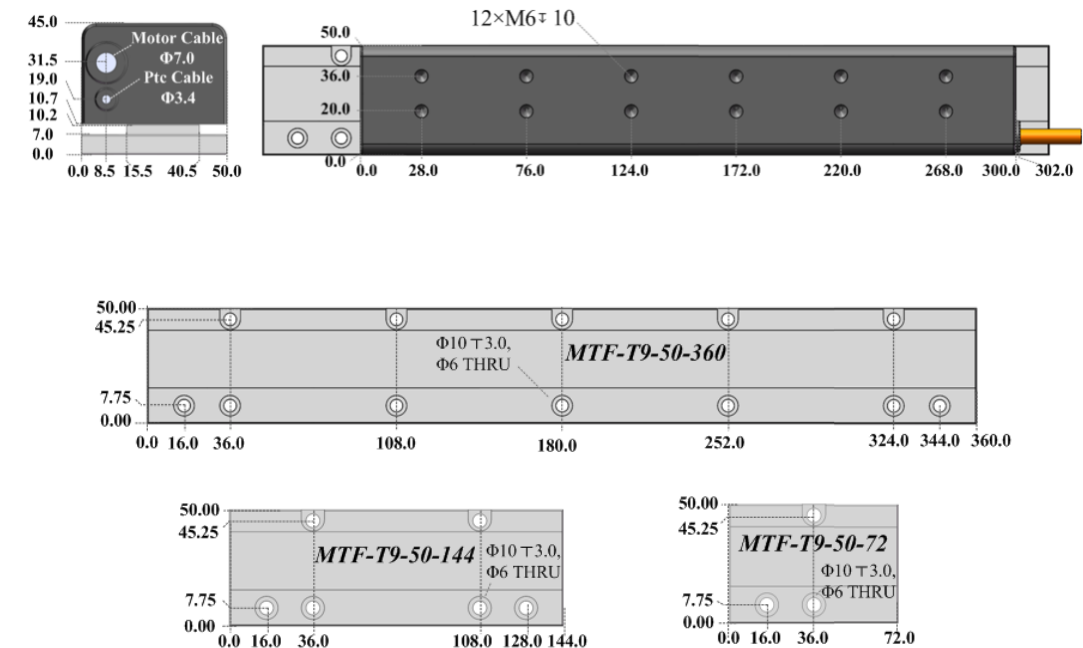

Curve of Force and Speed

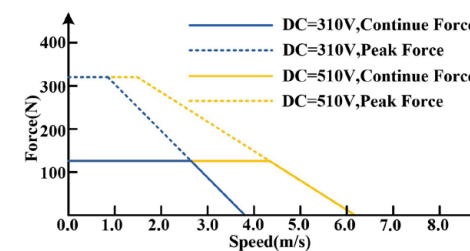

MTF- S2- 50- A

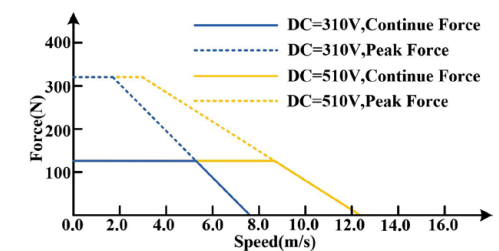

MTF- S2- 50- B

MTF- S2- 75- A(B)



PERFORMANCE

PARAMETERS

		MTF-S2-75-A	MTF-S2-75-B
Continue Force	N	306	306
Peak Force	N	692	692
Continue Current (RMS)	A	3.0	6.0
Peak Current (RMS)	A	12.0	24.0
Resistance(25°C) (L-L)	Ohm	3.2	0.8
Inductance (L-L)	mH	37.0	9.3
Maximum Speed at Continue	DC310V DC510V	2.4 3.9	4.8 7.8
Force Constant	N/A(RMS)	102.0	51.0
Back-EMF Constant (L-L)	V _{Peak} /(m/s)	88.0	44.0
Magnetic Period	mm	9.0	9.0
Attraction Force	N	2740	2740
Maximum Coil Temperature	°C	120	120
Thermal Sensor	PTC 3K Ohm		
Motor Constant	N/sqrt(W)	46.6	46.6
Electrical Time Constant	ms	11.6	11.6
Heat Dissipation Constant	W/°C	1.7	1.7
Mechanical Gap	mm	0.5	0.5
Mover weight	kg	3.6	3.6

- Note:** The data was obtained at the 20 °C ambient temperature, and the continuous current test is based on one carriage with 12mm thick and same length, 2 time of width of the mover. Any use of the motor beyond speed/force limit to motor damage and serious injuries. To ensure safe, customers should use the motor in the limited range. cannot be held responsible if the motor is used in an improper way.

Applicable Stators

Model	length(mm)	Width(mm)	Height(mm)	Weight(kg)	Mounting Holes
MTF-T9-75-72	72.0	75.0	10.2	0.29	Φ10.0 ± 3.0 Φ6.0 THRU
MTF-T9-75-144	144.0	75.0	10.2	0.58	
MTF-T9-75-360	360.0	75.0	10.2	1.45	

Mounting of Stators

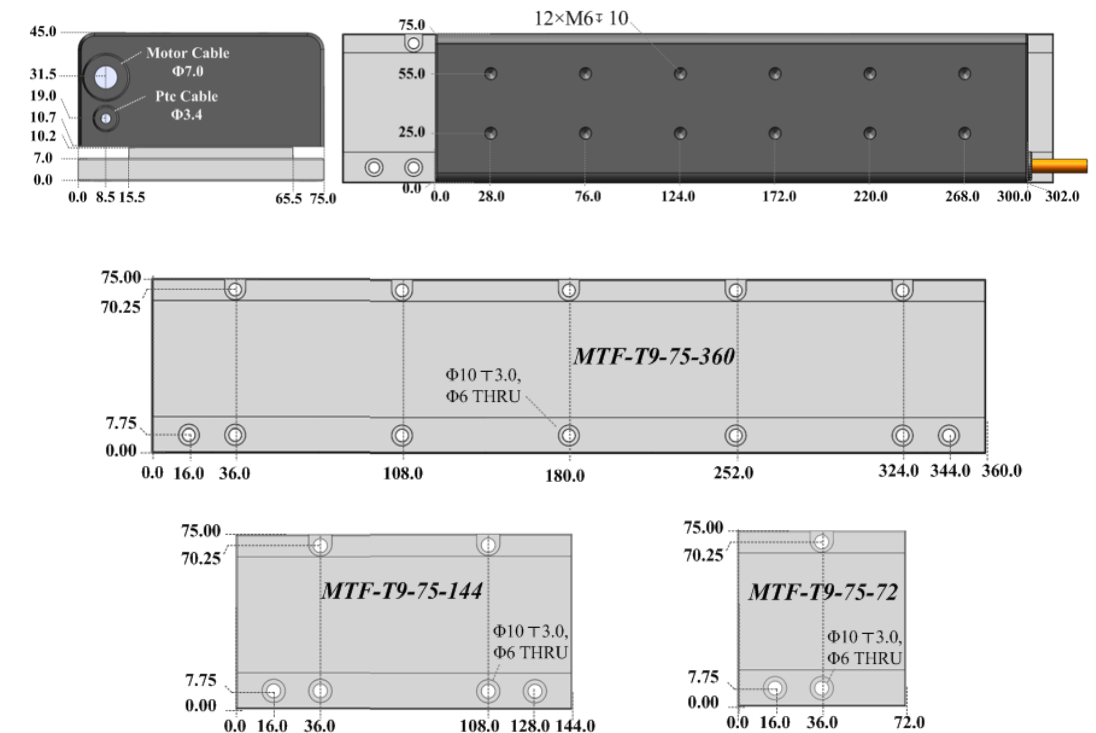

Curve of Force and Speed

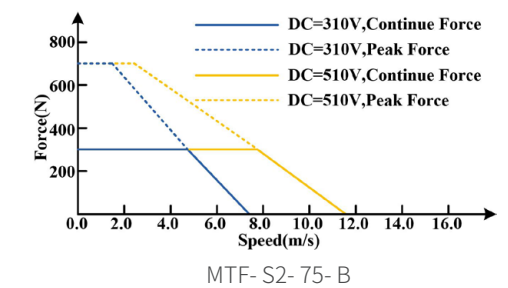
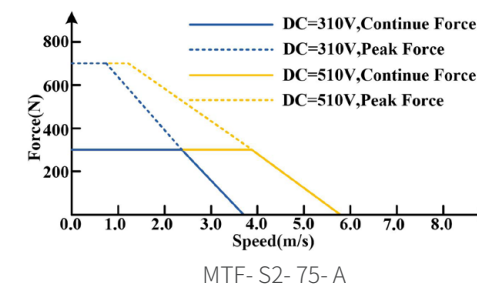

MTF- S2- 90- A(B)



PERFORMANCE

PARAMETERS

		MTF-S2-90-A	MTF-S2-90-B
Continue Force	N	492	492
Peak Force	N	958	958
Continue Current (RMS)	A	4.5	9.0
Peak Current (RMS)	A	18.0	36.0
Resistance(25°C) (L-L)	Ohm	1.8	0.4
Inductance (L-L)	mH	20.2	5.1
Maximum Speed at Continue	DC310V DC510V	2.7 4.3	5.4 8.6
Force Constant	N/A(RMS)	109.3	54.7
Back-EMF Constant (L-L)	V _{Peak} /(m/s)	87.6	43.8
Magnetic Period	mm	9.0	9.0
Attraction Force	N	3440	3440
Maximum Coil Temperature	°C	120	120
Thermal Sensor	PTC 3K Ohm		
Motor Constant	N/sqrt(W)	67.3	67.3
Electrical Time Constant	ms	11.5	11.5
Heat Dissipation Constant	W/°C	2.3	2.3
Mechanical Gap	mm	0.5	0.5
Mover Weight	kg	4.4	4.4

Note: The data was obtained at the 20 °C ambient temperature, and the continuous current test is based on one carriage with 12mm thick and same length, 2 time of width of the mover.

- Any use of the motor beyond speed/force limit to motor damage and serious injuries. To ensure safe, customers should use the motor in the limited range. cannot be held responsible if the motor is used in an improper way.

Applicable Stators

Model	length(mm)	Width(mm)	Height(mm)	Weight(kg)	Mounting Holes
MTF-T9-90-72	72.0	90.0	10.2	0.36	Φ10.0 ± 3.0 Φ6.0 THRU
MTF-T9-90-144	144.0	90.0	10.2	0.72	
MTF-T9-90-360	360.0	90.0	10.2	1.8	

Mounting of Stators

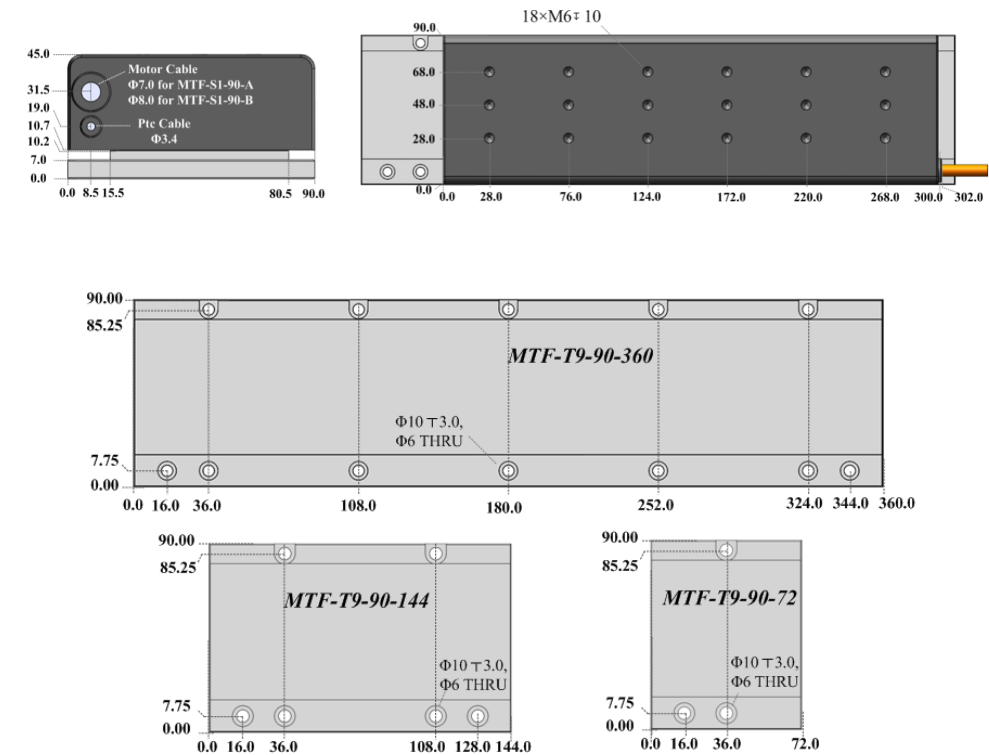

Curve of Force and Speed

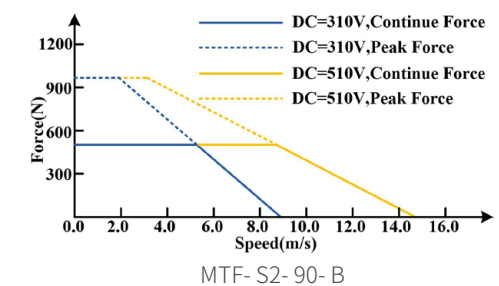
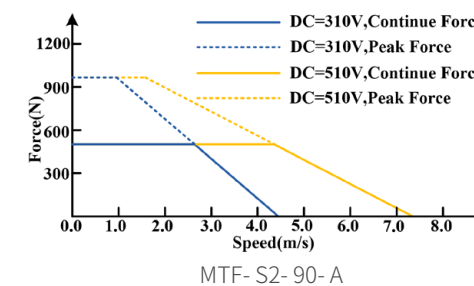

MTF- S2- 100- A(B)

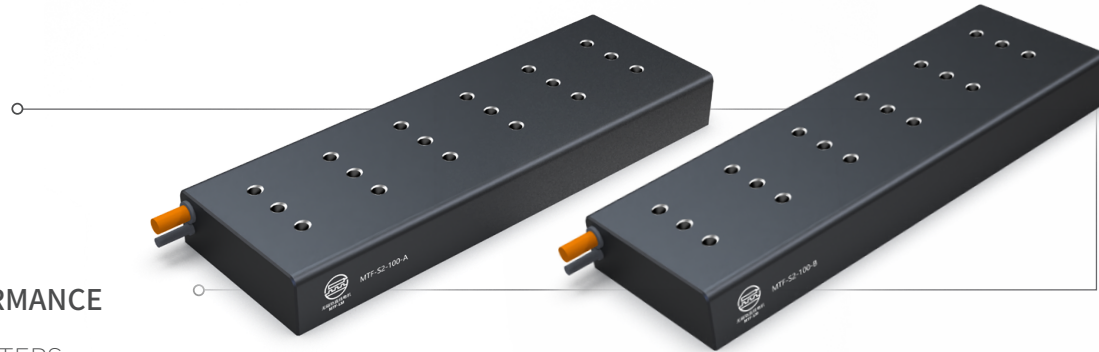

PERFORMANCE

PARAMETERS

		MTF-S2-100-A	MTF-S2-100-B
Continue Force	N	552	552
Peak Force	N	1076	1076
Continue Current (RMS)	A	4.5	9.0
Peak Current (RMS)	A	18.0	36.0
Resistance(25°C) (L-L)	Ohm	2.0	0.5
Inductance (L-L)	mH	23.6	5.9
Maximum Speed at Continue	DC310V	2.3	4.6
	DC510V	3.8	7.6
Force Constant	N/A(RMS)	122.7	61.3
Back-EMF Constant (L-L)	V _{Peak} /(m/s)	99.6	49.8
Magnetic Period	mm	9.0	9.0
Attraction Force	N	3900	3900
Maximum Coil Temperature	°C	120	120
Thermal Sensor	PTC 3K Ohm		
Motor Constant	N/sqrt(W)	70.8	70.8
Electrical Time Constant	ms	11.8	11.8
Heat Dissipation Constant	W/°C	2.6	2.6
Mechanical Gap	mm	0.5	0.5
Mover Weight	kg	4.9	4.9

Note: The data was obtained at the 20 °C ambient temperature, and the continuous current test is based on one carriage with 12mm thick and same length, 2 time of width of the mover.

- Any use of the motor beyond speed/force limit to motor damage and serious injuries. To ensure safe, customers should use the motor in the limited range. cannot be held responsible if the motor is used in an improper way.

Applicable Stators

Model	length(mm)	Width(mm)	Height(mm)	Weight(kg)	Mounting Holes
MTF-T9-100-72	72.0	100.0	10.2	0.4	Φ10.0 ± 3.0 Φ6.0 THRU
MTF-T9-100-144	144.0	100.0	10.2	0.8	
MTF-T9-100-360	360.0	100.0	10.2	2.0	

Mounting of Stators

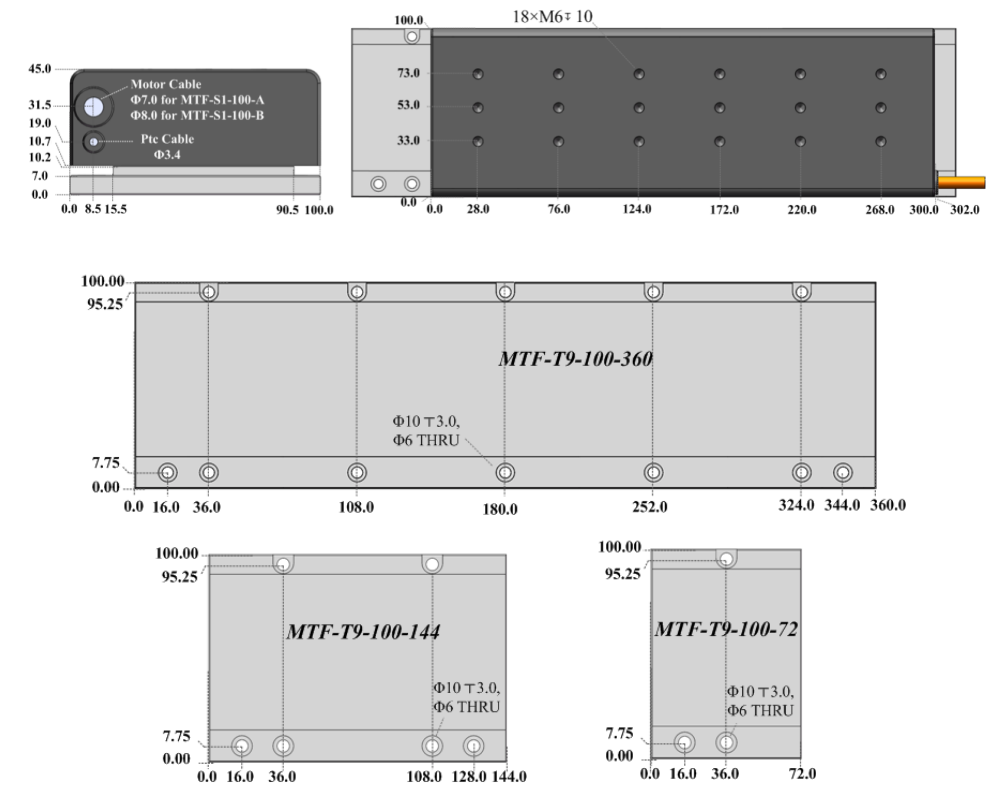

Curve of Force and Speed

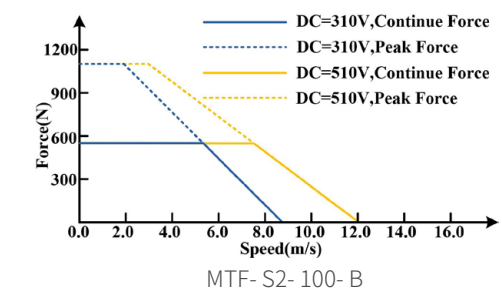
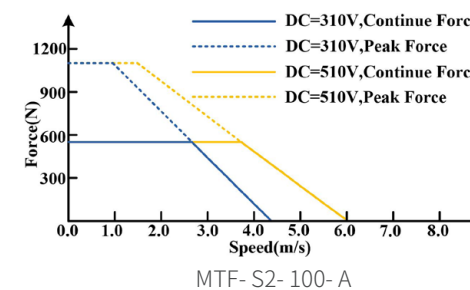

SEIDAL'S MTF-LM MODULE

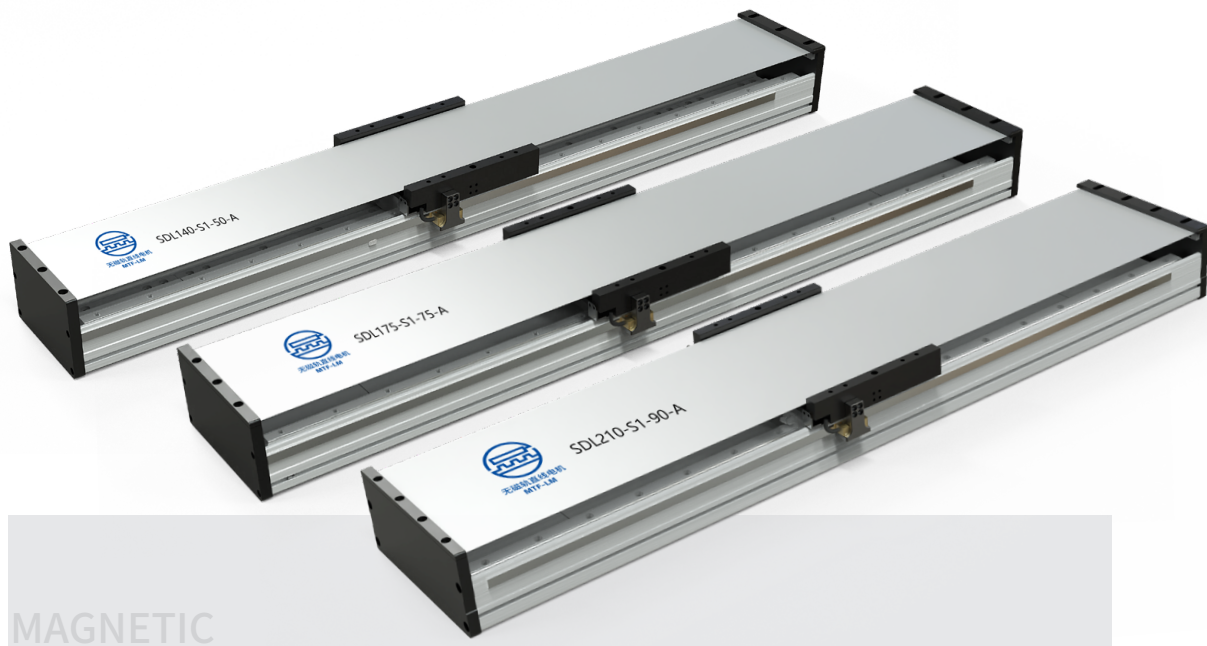

MAGNETIC TRACK-FREE LINEAR MOTOR MODULE

MTF linear motor module can be widely used in semiconductor field (such as crystal fixing machine, wire bonding machine, round crystal detection table), laser field (such as cutting, engraving, marking), electronic production equipment (such as XY axis, drilling, scribing, loading and unloading), medical equipment, seventh axis of robot, general automation and other fields due to its advantages of high precision, fast speed, fast dynamic response, safety and easy protection.

Due to that its module is equipped with a patented product-- the MTF linear motor, it can provide customers with better economic applicability.

FAST SELECTION CONTENT OF SDL MTF-LM MODULES

Series	Motor	Speed@ Rated Force	Continue Force/Peak Force						Travel Distance	Resolution	Repeatability
			50	100	200	400	800	1600			
SDL140	S1- 50- A	5.4m/s	62N/160N						100mm ~ 3000mm Optional Customized Available The other dimension is customizable	0.1um 0.5um 1.0um	±1.0um ±1.5um ±3.0um
	S1- 50- B	10.8m/s									
	S2- 50- A	2.7m/s	124N/320N								
	S2- 50- B	5.4m/s									
SDL175	S1- 75- A	4.8m/s	153N/346N								
	S1- 75- B	9.6m/s									
	S2- 75- A	2.4m/s	306N/692N								
	S2- 75- B	4.8m/s									
SDL210	S1- 90- A	5.4m/s	246N/479N								
	S1- 90- B	10.8m/s									
	S2- 90- A	2.7m/s	492N/958N								
	S2- 90- B	5.4m/s									
	S1- 100- A	4.6m/s	276N/538N								
	S1- 100- B	9.2m/s									
	S2- 100- A	2.3m/s	552N/1076N								
	S2- 100- B	4.6m/s									

SDL140- S1- 50- A(B)

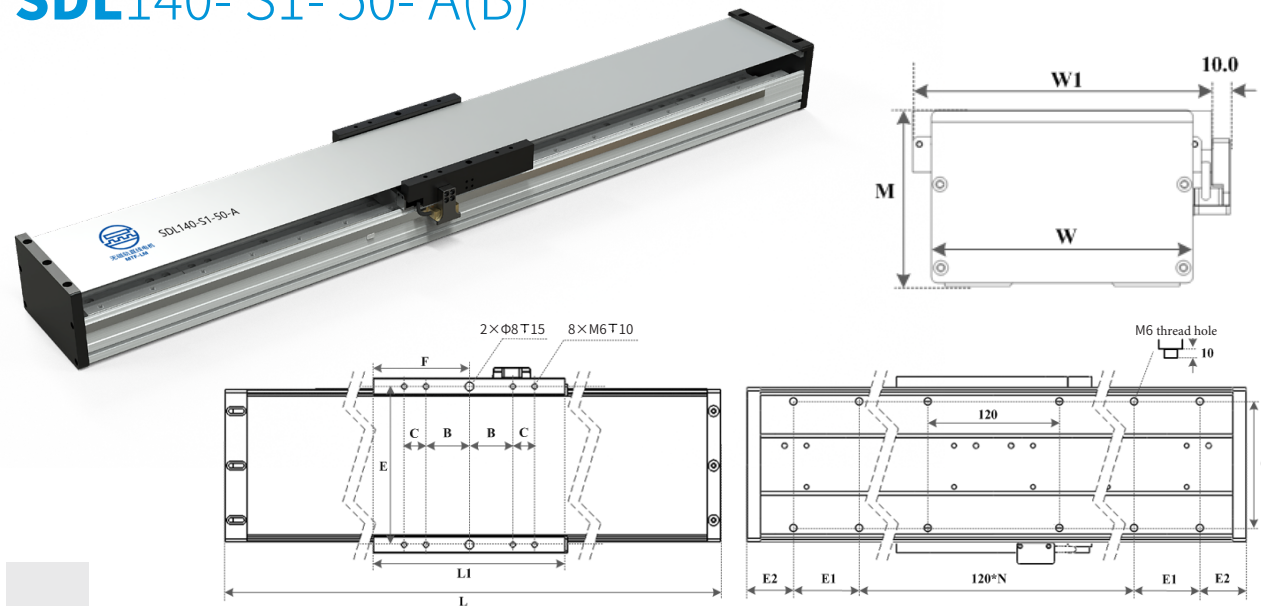

Instal Dimensions

Model No	Motor	Stroke (mm)	Total length (L)	Height (M)	Width (W)	(W1)	(L1)	(B)	(C)	(E)	(F)	(G)	(E1)	Installation holes Batches (E2)	Moving weight (kg)	Module weight (kg)
SDL140	S1-50-A(B)	100	394	95	140	160	176	40	20	145	88	115	60	1	77	8.1
		200	538											2	89	9.7
		300	610											3	65	10.5
		400	682											4	41	11.3
		500	826											5	53	12.9
		600	898											5	89	13.7
		700	1042											7	41	15.3
		800	1114											7	77	16.1
		900	1186											8	53	16.9
		1000	1330											9	65	18.5
		1100	1402											10	41	19.3
		1200	1546											11	53	20.9
		1300	1618											11	89	21.7
		1400	1690											12	65	22.4
		1500	1834											13	77	24
		1600	1906											14	53	24.8
		1700	1978											14	89	25.6
		1800	2122											16	41	27.2
		1900	2194											16	77	28
		2000	2338											17	89	29.6
		2100	2410											18	65	30.4
		2200	2482											19	41	31.2
		2300	2626											20	53	32.8
		2400	2698											20	89	33.6
		2500	2842											22	41	35.2
		2600	2914											22	77	36
2700	2986	23	53	36.8												
2800	3130	24	65	38.4												
2900	3202	25	41	39.2												
3000	3346	26	53	40.8												

Note: The other dimension is available upon request

Performance

Model No	SDL140- S1- 50- A	SDL140- S1- 50- B
Continue(N)	62	62
Peak force (N)	160	160
Continue current/ Peak current A	1.5/6.0	3.0/12.0
Supply voltage	1ph AC 220V or 3ph AC 380V	
Travel distance (mm)	100- 3000(other stroke can be customized) ±1.0um	
Repeatability (resolution ratio 0.1um)	±1.5um	
Repeatability (resolution ratio 0.5um)	±3.0um	
Repeatability (resolution ratio 1.0um)	±10um/1000mm	
Straightness (um)	Based on the marble with 5um straightness)	
Flatness(um)	Based on the marble with 5um straightness)	
Linear guide model	wide 15 rail	
Maximum load weight(kg)	200	
Maximum rolling torque (Nm)	180	
Maximum pitching torque (Nm)	250	
Maximum yawing torque (Nm)	250	
0.1um resolution) Advised maximum speed	1.6m/s - 4M (Due to the limitation of the driver)	
0.5um resolution) Advised maximum speed	4m/s Due to the limitation of bearing	
1.0um resolution) Advised maximum speed	4m/s Due to the limitation of bearing	

Curve of Force and Speed

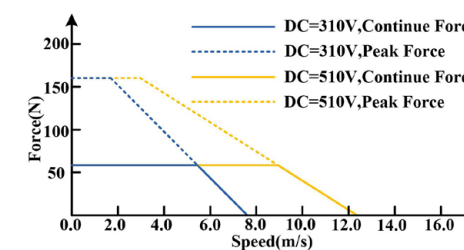

SDL140- S1- 50- A

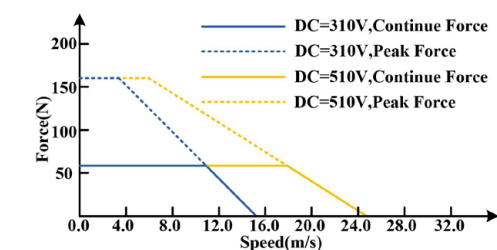

SDL140- S1- 50- B

SDL140- S2- 50- A(B)

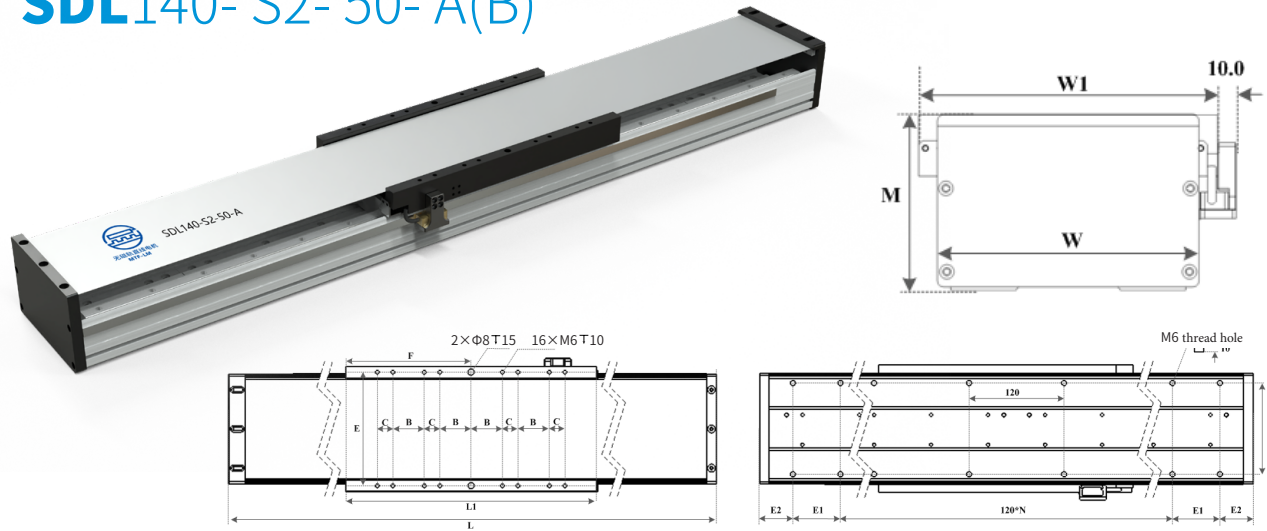

Instal Dimensions

Motor No	Motor	Stroke (mm)	Total length (L)	Height (M)	Width (W)	(W1)	(L1)	(B)	(C)	(E)	(F)	(G)	(E1)	Installation holes Batches	(E2)	Moving Module weight (kg)	weight (kg)
SDL140	S2-50-A(B)	100	538	95	140	160	320	40	20	145	160	115	60	2	89	5.1	11.6
		200	682											4	41	13.2	
		300	754											4	77	14	
		400	826											5	53	14.8	
		500	970											6	65	16.4	
		600	1042											7	41	17.2	
		700	1186											8	53	18.8	
		800	1258											8	89	19.6	
		900	1330											9	65	20.4	
		1000	1474											10	77	22	
		1100	1546											11	53	22.8	
		1200	1690											12	65	24.3	
		1300	1762											13	41	25.1	
		1400	1834											13	77	25.9	
		1500	1978											14	89	27.5	
		1600	2050											15	65	28.3	
		1700	2122											16	41	29.1	
		1800	2266											17	53	30.7	
		1900	2338											17	89	31.5	
		2000	2482											19	41	33.1	
		2100	2554											19	77	33.9	
		2200	2626											20	53	34.7	
		2300	2770											21	65	36.3	
		2400	2842											22	41	37.1	
		2500	2986											23	53	38.7	
		2600	3058											23	89	39.5	
		2700	3130											24	65	40.3	
	2800	3274	25	77	41.9												
	2900	3346	26	53	42.7												
	3000	3490	27	65	44.3												

Note: The other dimension is available upon request

Performance

Model no	SDL140-S2-50-A	SDL140-S2-50-B
Continue(N)	124	124
Peak force (N)	320	320
Continue current/ Peak current A	1.5/6.0	3.0/12.0
Supply voltage	1ph AC 220V or 3ph AC 380V	
Travel distance (mm)	100- 3000(customized stroke is available) ±1.0um	
Repeatability (0.1um)	±1.5um	
Repeatability (0.5um)	±3.0um	
Repeatability (1.0um)		
Straightness (um)	±10um/1000mm Based on the marble with 5um straightness)	
Flatness(um)	±10um/1000mm Based on the marble with 5um straightness)	
Linear guide model	wide 15 rail	
Maximum load weight(kg)	200	
Maximum rolling torque (Nm)	180	
Maximum pitching torque (Nm)	250	
Maximum yawing torque (Nm)	250	
(0.1um resolution) Advised maximum speed	1.6m/s 4M (Due to the limitation of the driver)	
(0.5um resolution) Advised maximum speed	4m/s Due to the limitation of bearing	
1.0um resolution) Advised maximum speed	4m/s Due to the limitation of bearing	

Curve of Force and Speed

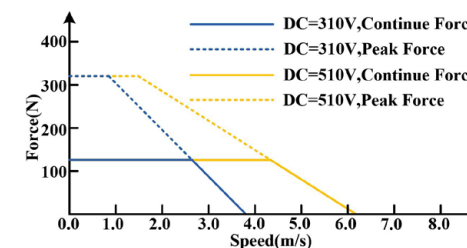

SDL140- S2- 50- A

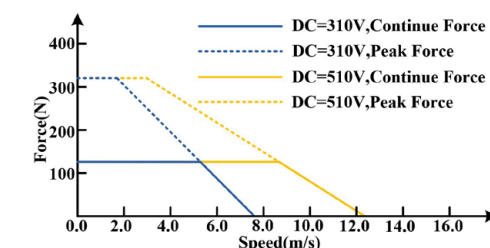

SDL140- S2- 50- B

SDL175- S1- 75- A(B)

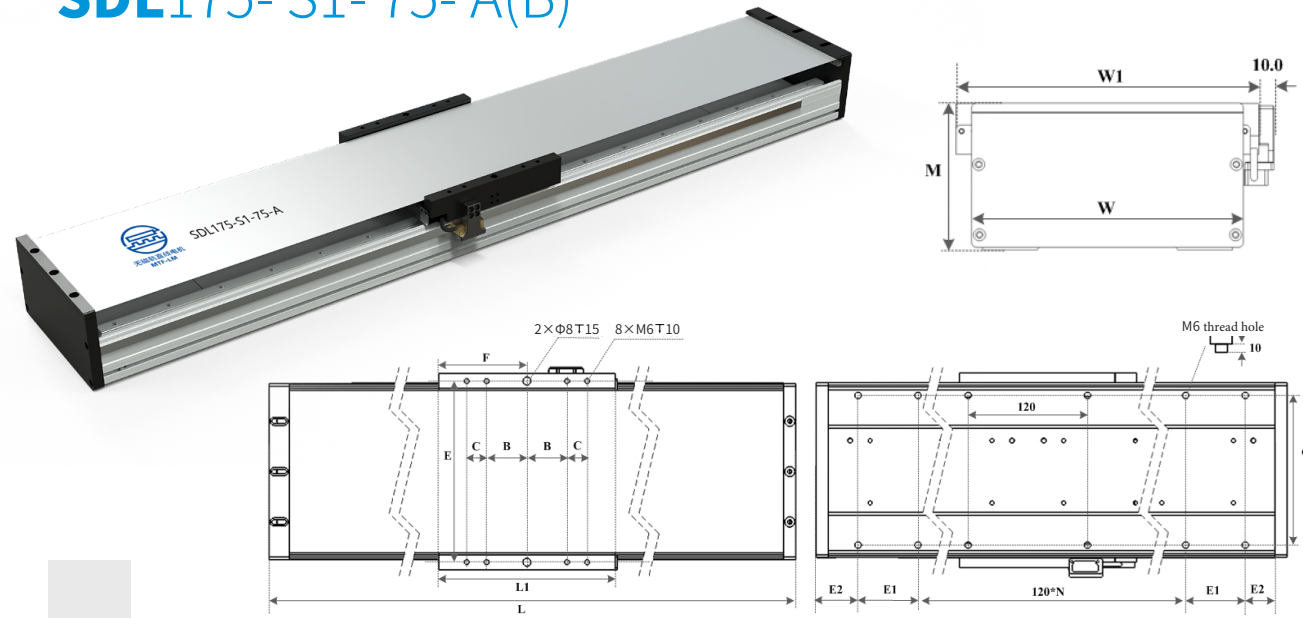

Instal Dimensions

Model no	Motor	Stroke (mm)	Total length (L)	Height (M)	Width (W)	(W1)	(L1)	(B)	(C)	(E)	(F)	(G)	(E1)	Installation hoels batches	(E2)	Moving Weight (kg)	Module Weight (kg)
SDL175	S1-75-A(B)	100	394	95	175	195	176	40	20	180	88	150	60	1	77	4.5	11
		200	538											2	89		13
		300	610											3	65		14.1
		400	682											4	41		15.1
		500	826											5	53		17.2
		600	898											5	89		18.3
		700	1042											7	41		20.4
		800	1114											7	77		21.4
		900	1186											8	53		22.5
		1000	1330											9	65		24.6
		1100	1402											10	41		25.6
		1200	1546											11	53		27.7
		1300	1618											11	89		28.8
		1400	1690											12	65		29.8
		1500	1834											13	77		31.9
		1600	1906											14	53		33
		1700	1978											14	89		34
		1800	2122											16	41		36.1
		1900	2194											16	77		37.2
		2000	2338											17	89		39.3
		2100	2410											18	65		40.3
		2200	2482											19	41		41.4
		2300	2626											20	53		43.5
		2400	2698											20	89		44.5
		2500	2842											22	41		46.6
		2600	2914											22	77		47.7
2700	2986	23	53	48.7													
2800	3130	24	65	50.8													
2900	3202	25	41	51.9													
3000	3346	26	53	54													

Note: Other stroke is available upon request

Performance

Model No	SDL175-S1-75-A	SDL175-S1-75-B
Continue(N)	153	153
Peak force (N)	346	346
Continue current/ Peak current A	3.0/12.0	6.0/24.0
Supply voltage	1ph AC 220V or 3ph AC 380V	
Travel distance (mm)	100- 3000(customized stroke is available) ±1.0um	
Repeatability (resolution 0.1um)	±1.5um	
Repeatability (resolution 0.5um)	±3.0um	
Repeatability (resolution 1.0um)	±10um/1000mm	
Straightness (um)	Based on the marble with 5um straightness)	
Flatness(um)	Based on the marble with 5um straightness)	
Linear guide type	Wide 15 rail	
Maximum load weight(kg)	200	
Maximum rolling torque (Nm)	180	
Maximum pitching torque (Nm)	250	
Maximum yawing torque (Nm)	250	
(0.1um resolution) Advised maximum speed	1.6m/s 4M (Due to the limitation of the driver)	
(0.5um resolution) Advised maximum speed	4m/s Due to the limitation of bearing	
(1.0um resolution) Advised maximum speed	4m/s Due to the limitation of bearing	

Curve of Force and Speed

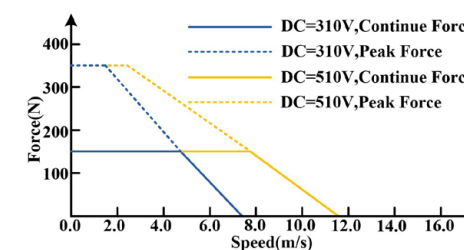

SDL175- S1- 75- A

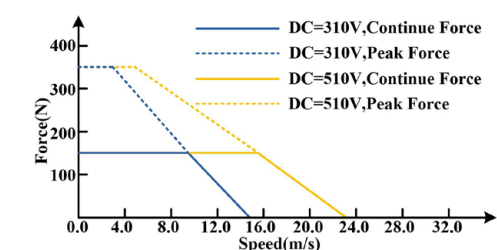

SDL175- S1- 75- B

SDL175- S2- 75- A(B)

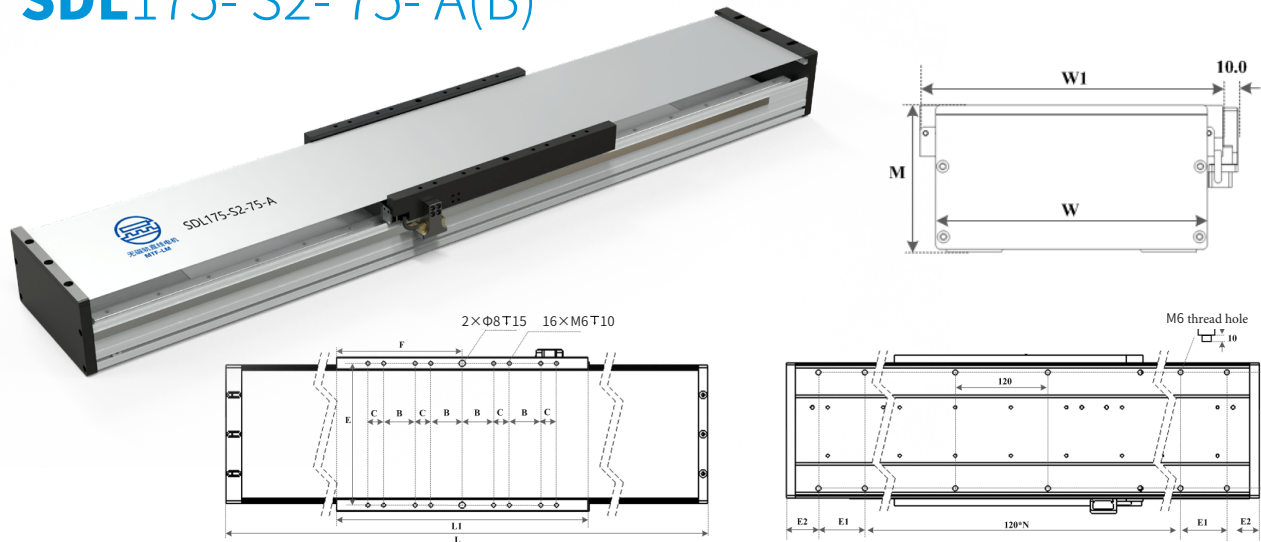

Instal Dimensions

Model no	Motor	Stroke (mm)	Total length (L)	Height (M)	Width (W)	(W1)	(L1)	(B)	(C)	(E)	(F)	(G)	(E1)	Installation holes		Moving Module weight	
														Batches	(E2)	(kg)	(kg)
SDL175	S2-75-A(B)	100	538	95	175	195	320	40	20	180	160	150	60	2	89	6.8	15.3
		4	41											17.4			
		300	754											4	77		18.5
		400	826											5	53		19.5
		500	970											6	65		21.6
		600	1042											7	41		22.7
		700	1186											8	53		24.8
		800	1258											8	89		25.8
		900	1330											9	65		26.9
		1000	1474											10	77		29
		1100	1546											11	53		30
		1200	1690											12	65		32.1
		1300	1762											13	41		33.2
		1400	1834											13	77		34.2
		1500	1978											14	89		36.3
		1600	2050											15	65		37.4
		1700	2122											16	41		38.4
		1800	2266											17	53		40.5
		1900	2338											17	89		41.6
		2000	2482											19	41		43.7
		2100	2554											19	77		44.7
		2200	2626											20	53		45.8
		2300	2770											21	65		47.9
		2400	2842											22	41		48.9
		2500	2986											23	53		51
		2600	3058											23	89		52.1
		2700	3130											24	65		53.1
2800	3274	25	77	55.2													
2900	3346	26	53	56.3													
3000	3490	27	65	58.4													

Note: Other stroke is available upon request

Performance

Model No	SDL175-S2-75-A	SDL175-S2-75-B
Continue(N)	306	306
Peak force (N)	692	692
Continue current/	3.0/12.0	6.0/24.0
Peak current A		
Supply voltage	1ph AC 220V or 3ph AC 380V	
Travel distance (mm)	100- 3000(customized stroke is available) ±1.0um	
Repeatability (resolution 0.1um)	±1.5um	
Repeatability (resolution 0.5um)	±3.0um	
Repeatability (resolution 1.0um)	±10um/1000mm	
Straightness (um)	Based on the marble with 5um straightness)	
	±10um/1000mm	
Flatness(um)	Based on the marble with 5um straightness)	
	±10um/1000mm	
Linear guide type	wide 15 rail	
Maximum load weight(kg)	200	
Maximum rolling torque (Nm)	180	
Maximum pitching torque (Nm)	250	
Maximum yawing torque (Nm)	250	
(0.1um resolution) Advised maximum speed	1.6m/s 4M (Due to the limitation of the driver)	
(0.5um resolution) Advised maximum speed	4m/s Due to the limitation of bearing	
(1.0um resolution) Advised maximum speed	4m/s Due to the limitation of bearing	

Curve of Force and Speed

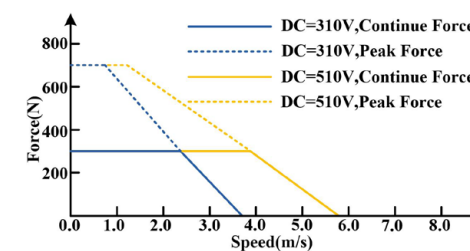

SDL175- S2- 75- A

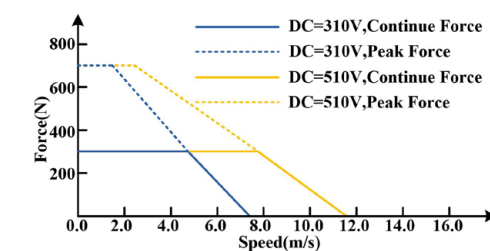

SDL175- S2- 75- B

SDL210- S1- 90- A(B)

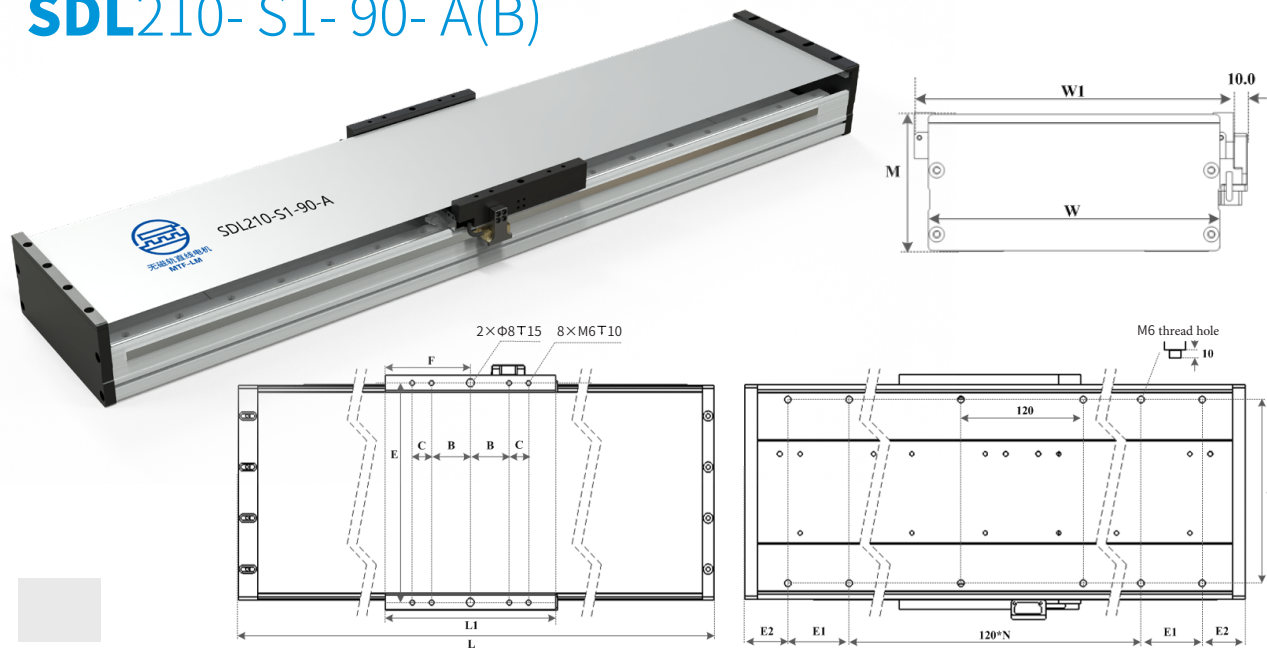

Instal Dimensions

Model no	Motor	Stroke (mm)	Total length (L)	Height (M)	Width (W)	(W1)	(L1)	(B)	(C)	(E)	(F)	(G)	(E1)	Installation holes Batches	(E2)	Moving weight (kg)	Module weight (kg)
SDL210	S1-90-A(B)	100	394	95	210	230	176	40	20	215	88	180	60	1	77	5.3	14.7
		200	538											2	89		17.7
		300	610											3	65		19.3
		400	682											4	41		20.8
		500	826											5	53		23.9
		600	898											5	89		25.4
		700	1042											7	41		28.5
		800	1114											7	77		30
		900	1186											8	53		31.6
		1000	1330											9	65		34.7
		1100	1402											10	41		36.2
		1200	1546											11	53		39.3
		1300	1618											11	89		40.8
		1400	1690											12	65		42.4
		1500	1834											13	77		45.4
		1600	1906											14	53		47
		1700	1978											14	89		48.5
		1800	2122											16	41		51.6
		1900	2194											16	77		53.1
		2000	2338											17	89		56.2
		2100	2410											18	65		57.7
		2200	2482											19	41		59.3
		2300	2626											20	53		62.4
		2400	2698											20	89		63.9
		2500	2842											22	41		67
		2600	2914											22	77		68.5
2700	2986	23	53	70													
2800	3130	24	65	73.1													
2900	3202	25	41	74.7													
3000	3346	26	53	77.7													

Note: Other stroke is available upon request

Performance

Model no	SDL210-S1-90-A	SDL210-S1-90-B
Continue(N)	246	246
Peak force (N)	479	479
Continue current/	4.5/18.0	9.0/36.0
Peak current A		
Supply voltage	1ph AC 220V or 3ph AC 380V	
Travel distance (mm)	100- 3000(customized stroke is available) ±1.0um	
Repeatability (resolution 0.1um)	±1.5um	
Repeatability (0.5um)	±3.0um	
Repeatability (1.0um)		
Straightness (um)	±10um/1000mm Based on the marble with 5um straightness)	
Flatness(um)	±10um/1000mm Based on the marble with 5um straightness)	
Linear Guide type	wide 20 rail	
Maximum load weight(kg)	300	
Maximum rolling torque (Nm)	260	
Maximum pitching torque (Nm)	300	
Maximum yawing torque (Nm)	300	
(0.1um resolution) Advised maximum speed	1.6m/s 4M (Due to the limitation of the driver)	
(0.5um resolution) Advised maximum speed	4m/s Due to the limitation of bearing	
(1.0um resolution) Advised maximum speed	4m/s Due to the limitation of bearing	

Curve of Force and Speed

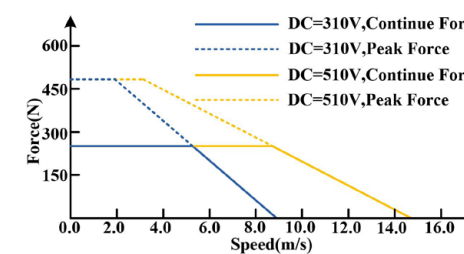

SDL210- S1- 90- A

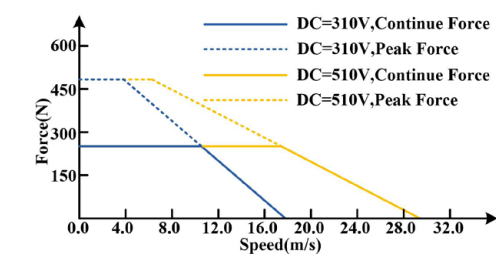

SDL210- S1- 90- B

SDL210- S2- 90- A(B)

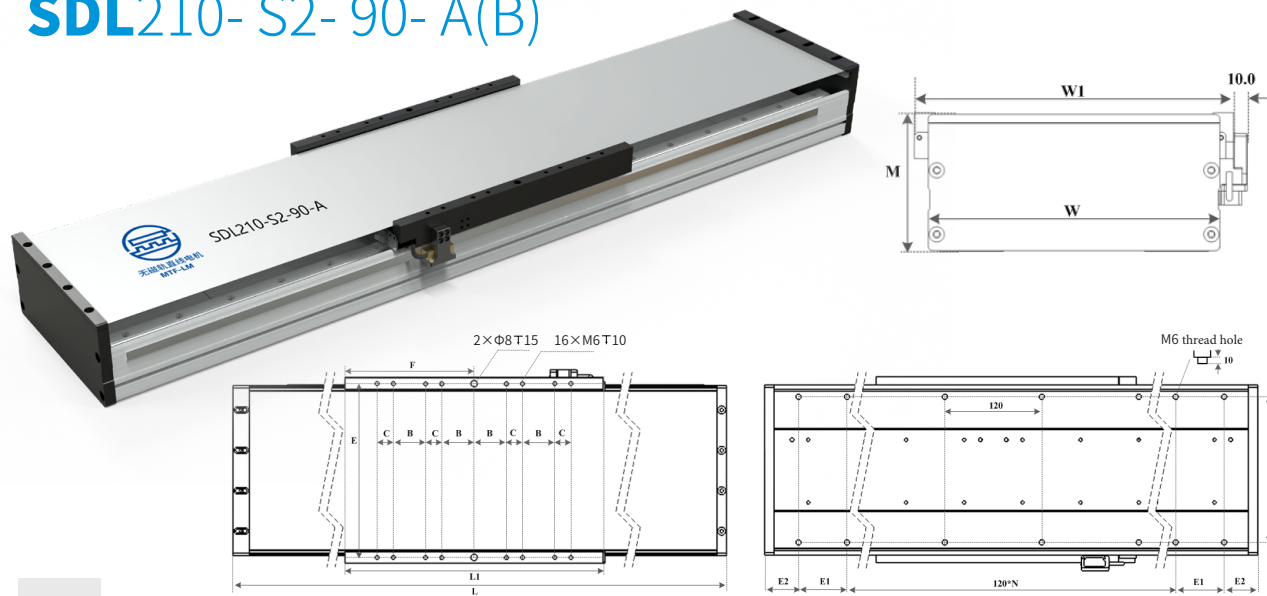

Instal Dimensions

Model no	Motor	Stroke (mm)	Total length (L)	Height (M)	Width (W)	(W1)	(L1)	(B)	(C)	(E)	(F)	(G)	(E1)	Installation holes Batches (E2)	Moving weight (kg)	Module weight (kg)
SDL210	S2-90-A(B)	100	538	95	210	230	320	40	20	215	160	180	60	2	89	20.4
		200	682											4	41	23.5
		300	754											4	77	25.1
		400	826											5	53	26.6
		500	970											6	65	29.7
		600	1042											7	41	31.2
		700	1186											8	53	34.3
		800	1258											8	89	35.8
		900	1330											9	65	37.4
		1000	1474											10	77	40.4
		1100	1546											11	53	42
		1200	1690											12	65	45.1
		1300	1762											13	41	46.6
		1400	1834											13	77	48.1
		1500	1978											14	89	51.2
		1600	2050											15	65	52.7
		1700	2122											16	41	54.3
		1800	2266											17	53	57.4
		1900	2338											17	89	58.9
		2000	2482											19	41	62
		2100	2554											19	77	63.5
		2200	2626											20	53	65.1
		2300	2770											21	65	68.1
		2400	2842											22	41	69.7
		2500	2986											23	53	72.7
		2600	3058											23	89	74.3
		2700	3130											24	65	75.8
2800	3274	25	77	78.9												
2900	3346	26	53	80.4												
3000	3490	27	65	83.5												

Note: Other stroke is available upon request

Performance

Model no	SDL210-S2-90-A	SDL210-S2-90-B
Continue(N)	492	492
Peak force (N)	958	958
Continue current/ Peak current A	4.5/18.0	9.0/36.0
Supply voltage	1ph AC 220V or 3ph AC 380V	
Travel distance (mm)	100- 3000(customized stroke is available) ±1.0um	
Repeatability (resolution 0.1um)	±1.5um	
Repeatability (resolution 0.5um)	±3.0um	
Repeatability (resolution 1.0um)	±10um/1000mm	
Straightness (um)	Based on the marble with 5um straightness)	
Flatness(um)	Based on the marble with 5um straightness)	
Linear guide type	wide 20 rail	
Maximum load weight(kg)	300	
Maximum rolling torque (Nm)	260	
Maximum pitching torque (Nm)	300	
Maximum yawing torque (Nm)	300	
(0.1um resolution) Advised maximum speed	1.6m/s 4M (Due to the limitation of the driver)	
(0.5um resolution) Advised maximum speed	4m/s Due to the limitation of bearing	
(1.0um resolution) Advised maximum speed	4m/s Due to the limitation of bearing	

Curve of Force and Speed

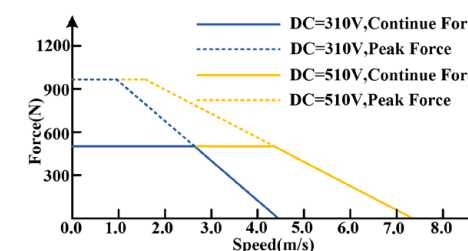

SDL210- S2- 90- A

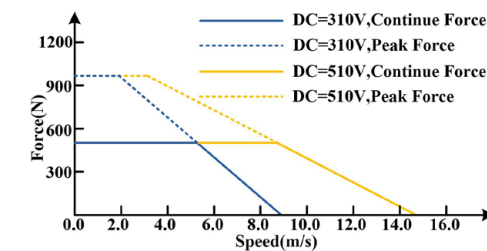

SDL210- S2- 90- B

SDL210- S1- 100- A(B)

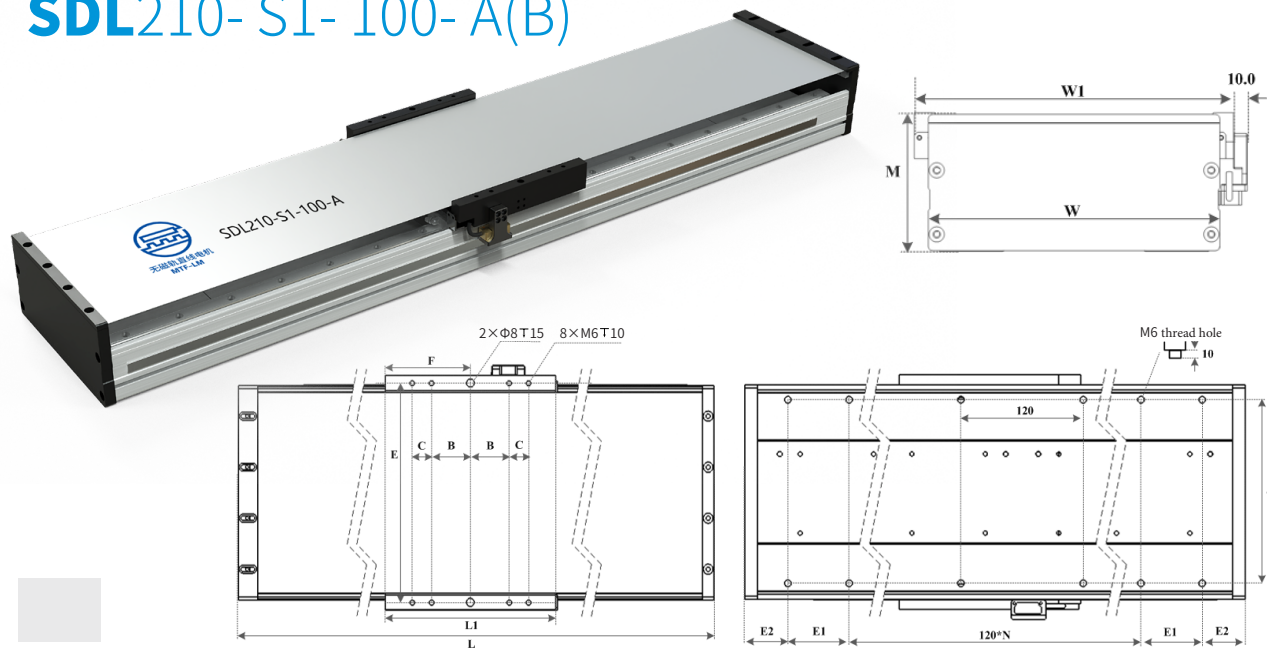

Instal Dimensions

Model no	Motor Stroke (mm)	Total length (L)	Height (M)	Width		(L1)	(B)	(C)	(E)	(F)	(G)	(E1)	Installation holes		Moving weight (kg)	Module weight (kg)
				(W)	(W1)								Batches	(E2)		
SDL210 S1-100-A(B)	100	394	95	210	230	176	40	20	215	88	180	60	1	77	5.6	15.2
	200	538											2	89		18.3
	300	610											3	65		19.9
	400	682											4	41		21.5
	500	826											5	53		24.6
	600	898											5	89		26.2
	700	1042											7	41		29.4
	800	1114											7	77		30.9
	900	1186											8	53		32.5
	1000	1330											9	65		35.7
	1100	1402											10	41		37.3
	1200	1546											11	53		40.4
	1300	1618											11	89		42
	1400	1690											12	65		43.6
	1500	1834											13	77		46.7
	1600	1906											14	53		48.3
	1700	1978											14	89		49.9
	1800	2122											16	41		53
	1900	2194											16	77		54.6
	2000	2338											17	89		57.8
	2100	2410											18	65		59.4
	2200	2482											19	41		60.9
	2300	2626											20	53		64.1
	2400	2698											20	89		65.7
	2500	2842											22	41		68.8
	2600	2914											22	77		70.4
2700	2986	23	53	72												
2800	3130	24	65	75.1												
2900	3202	25	41	76.7												
3000	3346	26	53	79.9												

Note: Other stroke is available upon request

Performance

Model no	SDL210-S1-100-A	SDL210-S1-100-B
Continue(N)	276	276
Peak force (N)	538	538
Continue current/ Peak current A	4.5/18.0	9.0/36.0
Supply voltage	1ph AC 220V or 3ph AC 380V	
Travel distance (mm)	100- 3000(customized stroke is available) ±1.0um	
Repeatability (resolution 0.1um)	±1.5um	
Repeatability (resolution 0.5um)	±3.0um	
Repeatability (resolution 1.0um)	±10um/1000mm	
Straightness (um)	Based on the marble with 5um straightness)	
Flatness(um)	Based on the marble with 5um straightness)	
Linear guide type	wide 20 rail	
Maximum load weight(kg)	300	
Maximum rolling torque (Nm)	260	
Maximum pitching torque (Nm)	300	
Maximum yawing torque (Nm)	300	
(0.1um resolution) Advised maximum speed	1.6m/s 4M (Due to the limitation of the driver)	
(0.5um resolution) Advised maximum speed	4m/s Due to the limitation of bearing	
(1.0um resolution) Advised maximum speed	4m/s Due to the limitation of bearing	

Curve of Force and Speed

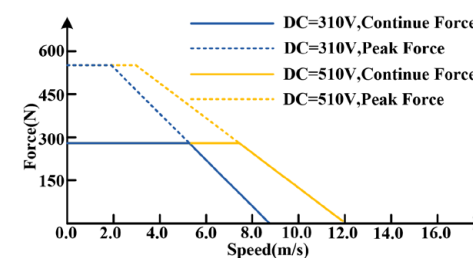

SDL210- S1- 100- A

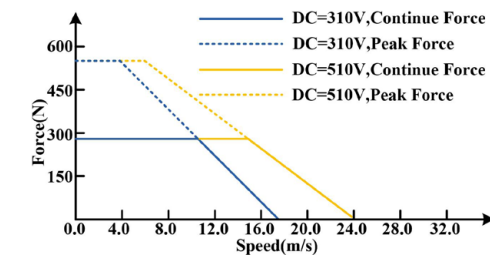

SDL210- S1- 100- B

SDL210- S2- 100- A(B)

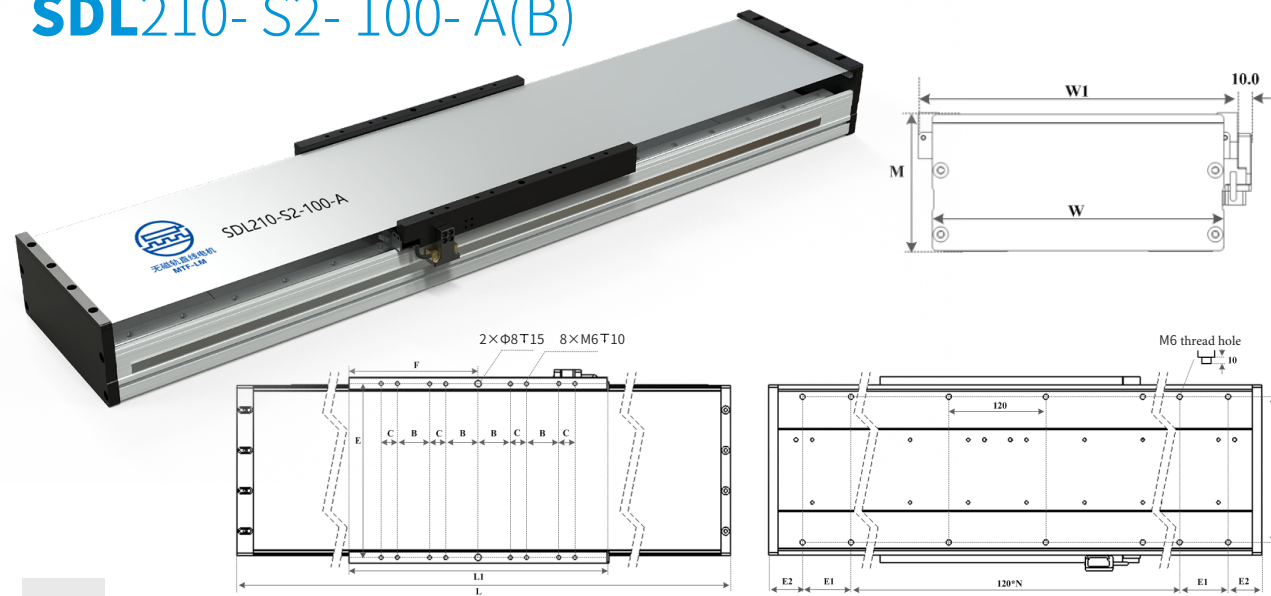

Instal Dimensions

Model no	Motor Stroke (mm)	Total length (L)	Height (M)	Width		(L1)	(B)	(C)	(E)	(F)	(G)	(E1)	Installation holes		Moving Module weight (kg)	
				(W)	(W1)								Batches	(E2)		
SDL210 S2-100-A(B)	100	538	95	210	230	320	40	20	215	160	180	60	2	89	8.3	21
	200	682											4	41		24.2
	300	754											4	77		25.8
	400	826											5	53		27.3
	500	970											6	65		30.5
	600	1042											7	41		32.1
	700	1186											8	53		35.2
	800	1258											8	89		36.8
	900	1330											9	65		38.4
	1000	1474											10	77		41.5
	1100	1546											11	53		43.1
	1200	1690											12	65		46.3
	1300	1762											13	41		47.9
	1400	1834											13	77		49.4
	1500	1978											14	89		52.6
	1600	2050											15	65		54.2
	1700	2122											16	41		55.7
	1800	2266											17	53		58.9
	1900	2338											17	89		60.5
	2000	2482											19	41		63.6
	2100	2554											19	77		65.2
	2200	2626											20	53		66.8
	2300	2770											21	65		70
	2400	2842											22	41		71.5
	2500	2986											23	53		74.7
	2600	3058											23	89		76.3
	2700	3130											24	65		77.8
2800	3274	25	77	81												
2900	3346	26	53	82.6												
3000	3490	27	65	85.7												

Note: Other stroke is available upon request

Performance

Model no	SDL210-S2-100-A	SDL210-S2-100-B
Continue(N)	552	552
Peak force (N)	1076	1076
Continue current/ Peak current A	4.5/18.0	9.0/36.0
Supply voltage	1ph AC 220V or 3ph AC 380V	
Travel distance (mm)	100- 3000(customized stroke is available) ±1.0um	
Repeatability (resolution 0.1um)	±1.5um	
Repeatability (resolution 0.5um)	±3.0um	
Repeatability (resolution 1.0um)	±10um/1000mm	
Straightness (um)	Based on the marble with 5um straightness)	
Flatness(um)	Based on the marble with 5um straightness)	
Linear guide type	wide 20 rail	
Maximum load weight(kg)	300	
Maximum rolling torque (Nm)	260	
Maximum pitching torque (Nm)	300	
Maximum yawing torque (Nm)	300	
(0.1um resolution) Advised maximum speed	1.6m/s 4M (Due to the limitation of the driver)	
(0.5um resolution) Advised maximum speed	4m/s Due to the limitation of bearing	
(1.0um resolution) Advised maximum speed	4m/s Due to the limitation of bearing	

Curve of Force and Speed

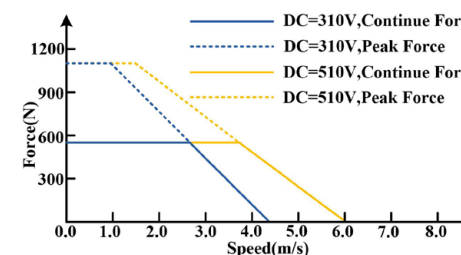

SDL210- S2- 100- A

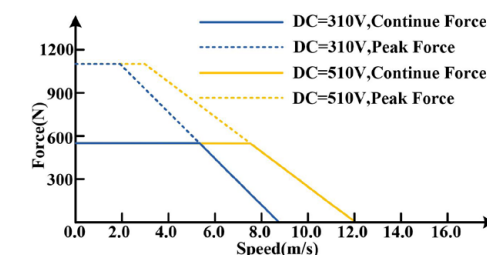

SDL210- S2- 100- B

CODING OF MTF LINEAR MOTOR AND IT'S MODULES

MTF LINEAR MOTOR MOVER 01

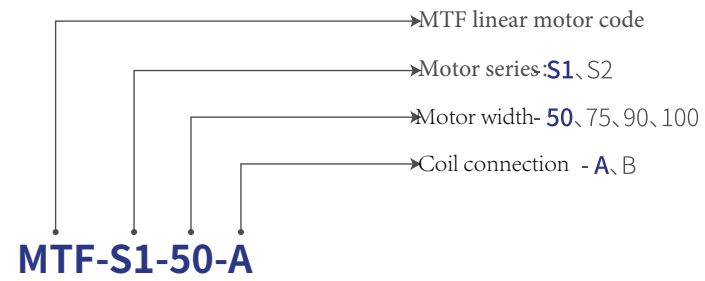

MTF linear motor stator 02

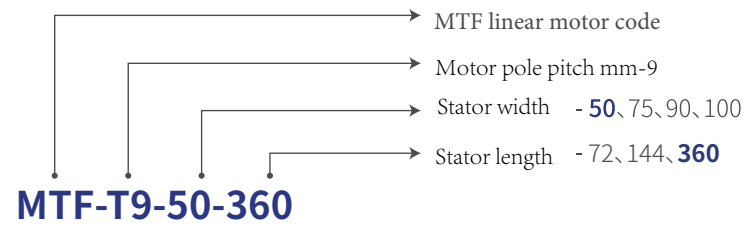

MTF linear motor module 03

