



SPECIFICATION

Current Rating: 3.0Amp
 Insulation Resistance: 1000MΩ min
 Contact Resistance: 20MΩ max
 Withstand Voltage: 1000V AC/DC
 Operating Temperature: -40° C to +105° C
 Contact Material: Brass
 Contact Plating: Au or Sn Over Ni
 Insulator Material: PBT or PA6T+30%GF UL 94V-0

Ordering Code:

LHDR05 - X - X - X - X - X - X

① ② ③ ④ ⑤ ⑥ ⑦

- ① Series No:
- ② No. of Contacts
6 8 10 12
14 16 18 20
24 26 30 34
40 50 60 64
- ③ Contact Plating:
G0:Gold flash S0:Selective
G1:3U" Gold S1:Selective 3u"
G2:5u" Gold S2:Selective 5u"
G3:10u" Gold S3:Selective 10u"
G4:15u" Gold S4:Selective 15u"
G5:30u" Gold S5:Selective 30u"
SN:Tin
- ④ Color Insulator
B:Black
U:Blue
G:Gray
- ⑤ Insulator Material
A:PBT
B:PA6T
C:LCP
D:PA46
E:PA9T
- ⑥ Packing
A:Tray
B:Bag
T:Tube
U:Tube+CAP
R:Tape&Reel
W:Tape&Reel+CAP
- ⑦ A:Short Latch
B:Long Latch
C:Without Latch

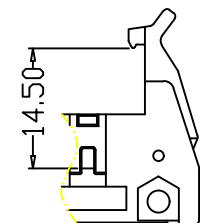
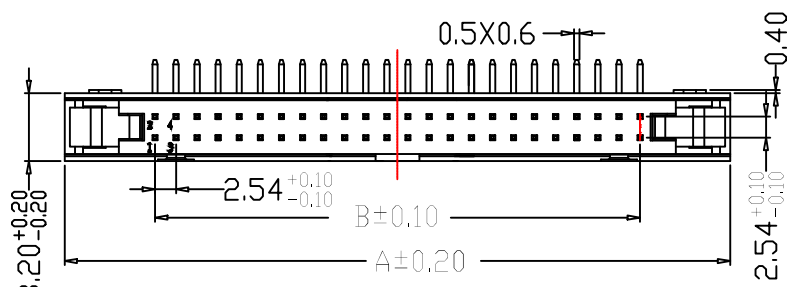

Long Lever
Type1

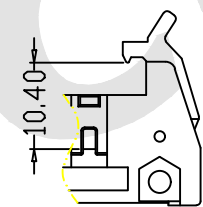
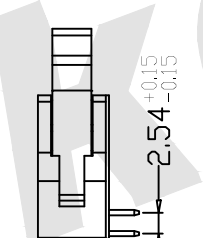
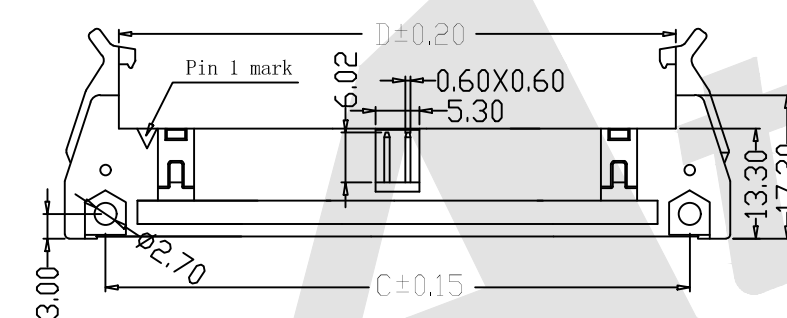

Short Lever
Type2

Position	A	B	C	D
06	26.86	5.08	16.76	12.76
08	29.40	7.62	19.30	15.30
10	31.94	10.16	21.84	17.84
14	37.02	15.24	26.92	22.96
16	39.56	17.78	29.46	25.46
20	44.64	22.86	34.54	30.54
26	52.26	30.48	42.16	38.16

Position	A	B	C	D
30	57.34	35.56	47.24	43.24
34	62.42	40.64	52.32	48.32
40	70.04	48.26	59.94	55.94
50	82.74	60.96	72.64	68.64
60	95.44	73.66	85.34	81.34
64	100.52	78.74	90.42	86.42

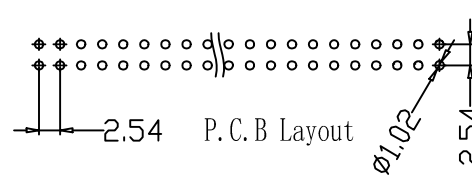

10P-18P Without Slot "B" and "A"
 20P-58P With Slot "B", Without Slot "A",
 60P-64P With Slot "B" and "A"

Unless Otherwise specified tolerance
 X. ±0.35 X.XX: ±0.20
 X.X: ±0.25 X.XXX: ±0.15

SCALE: As Shown UNIT: mm
 DRAW: ZLA DATE: 24/04/2022
 CHECK: BobYang DATE: 24/04/2022

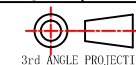

Atkconn® ATKCONN ELECTRONICS CO., LTD
[Http://www.atkconn.com](http://www.atkconn.com)

TITLE:
2.54mm Ejector Header Angle Type
With Lever

DRAWING NO: LHDR05-XXXXXX
 PRODUCT NO: LHDR05-XXXXXX

REV	DESCRIPTION	DATE