

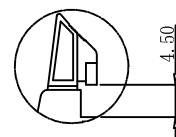

SPECIFICATION

Current Rating: 3.0Amp
 Insulation Resistance: 1000MΩ min
 Contact Resistance: 20MΩ max
 Withstand Voltage: 1000V AC/DC
 Operating Temperature: -40°C to +105°C
 Contact Material: Brass
 Contact Plating: Au Over Ni
 Latch plating: Ni
 Insulator Material: PBT +30%GF UL 94V-0

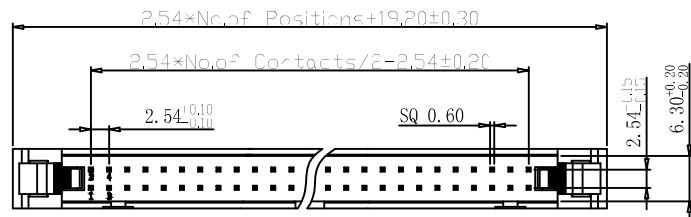

A:Short Latch

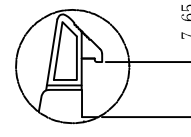

B:Long Latch

Ordering Code:

LHD102 - X - X - X - X - X - X
 ① ② ③ ④ ⑤ ⑥ ⑦

- ① Series No:
06 08 10 12
14 16 18 20
24 26 30 34
40 50 60 64
- ② No.of Contacts
06 08 10 12
14 16 18 20
24 26 30 34
40 50 60 64
- ③ Contact Plating:
G0:Gold flash S0:Selective
G1:3U" Gold S1:Selective 3u"
G2:5u" Gold S2:Selective 5u"
G3:10u "Gold S3:Selective 10u"
G4:15u" Gold S4:Selective 15u"
G5:30u" Gold S5:Selective 30u"
SN:Tin
- ④ Color Insulator
B:Black
U:Blue
G:Gray
- ⑤ Insulator Material
A:PBT
B:PA6T
C:LCP
D:PA46
E:PA9T
- ⑥ Packing
A:Tray
T:Tube
U:Tube+CAP
R:Tape&Reel
W:Tape&Reel+CAP
- ⑦ A:Short Latch
B:Long Latch
C:Without Latch

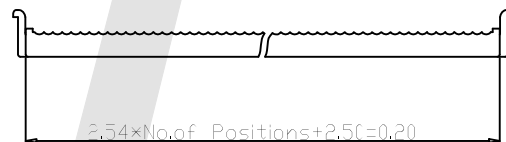
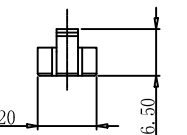
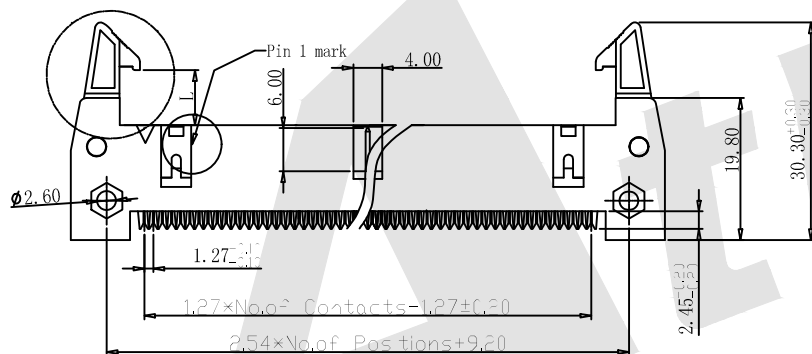

Unless Otherwise specified tolerance
 X. ±0.35 X.XX: ±0.20
 X.X: ±0.25 X.XXX: ±0.15

SCALE: As Shown UNIT: mm
 DRAW ZLA DATE 24/04/2022
 CHECK BobYang DATE 24/04/2022

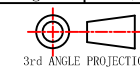

Atkconn® ATKCONN ELECTRONICS CO., LTD
[Http://www.atkconn.com](http://www.atkconn.com)

TITLE: 2.54mm Ejector Header IDC Type
 Without Mounting Ears

DRAWING NO: LHD102-XXXXXX

PRODUCT NO: LHD102-XXXXXX

REV	DESCRIPTION	DATE