

HSF



ROHS

Note

- 1. Base Material: Nylon Resin, Black.
- 2. Flammability Rating: UL94V-0.
- 3. Contacts: 0.35 Phosphor Bronze Flash Gold
- 4. Dielectric Strength: 560 Volts/Mill, at 25° C

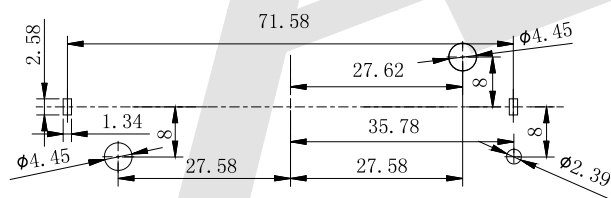
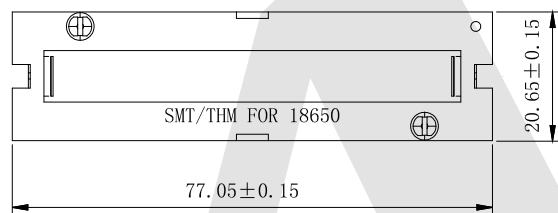
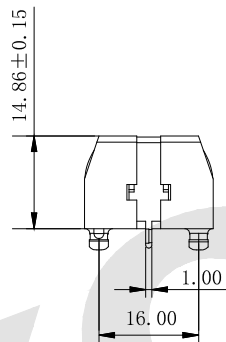
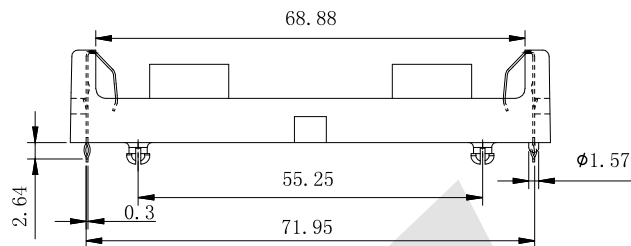
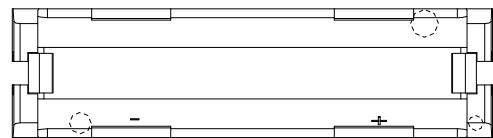

PCB LAYOUT

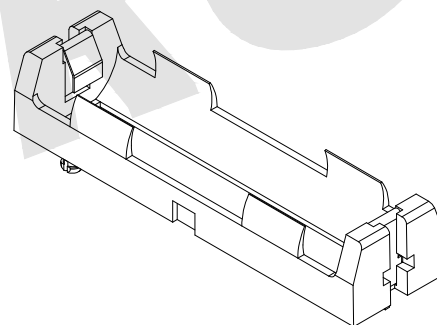

Ordering Code:

BT - M - G0 - R - 18650 - 1  
 ① ② ③ ④ ⑤

- ① BT: Battery Holders
- ② Appearance For The Product  
M: SMT TYPE  
S: 180 TYPE  
R: 90 TYPE
- ③ Contact Plating:  
G0: Gold flash G1: 3u" Gold  
G2: 5u" Gold G3: 10u" Gold  
G4: 15u" Gold G5: 30u" Gold  
SN: Tin SI: NICKEL PLATED
- ④ Parking method  
A: Tray packing  
R: Tape & reel packing
- ⑤ Product number  
2AA-1  
18650-1

Unless Otherwise specified tolerance  
 X. ±0.35 X.XX: ±0.20  
 X.X: ±0.25 X.XXX: ±0.15

SCALE: As Shown UNIT: mm  
 DRAW ZLA DATE 21/07/2022  
 CHECK BobYang DATE 21/07/2022

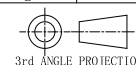

**Atkconn**® ATKCONN ELECTRONICS CO., LTD  
[Http://www.atkconn.com](http://www.atkconn.com)

TITLE: Coin Cell Battery Holders  
 For One Li-ion 18650 DIP

DRAWING NO: BT-S-G0-R-18650-1

PRODUCT NO: BT-S-G0-R-18650-1

REV	DESCRIPTION	DATE
1		
2		
3		
4		
5		