

HSF



ROHS

SPECIFICATION

Current Rating: 3.0Amp
 Insulation Resistance: 1000MΩ min
 Contact Resistance: 20MΩ max
 Withstand Voltage: 500V AC/DC
 Operating Temperature: -40°C to +105°C
 Contact Material: Brass
 Contact Plating: Au or Sn Over Ni
 Insulator Material: PBT UL 94V-0

10~16 Pin Without "A"

Ordering Code:

BHDI02 - X - X - X - X - X
 ① ② ③ ④ ⑤ ⑥

- ① Series No:
- ② No. of Contacts
 6 8 10 12
 14 16 18 20
 24 26 30 34
 40 50 60 64
- ③ Contact Plating:
 G0: Gold flash S0: Selective
 G1: 3u" Gold S1: Selective 3u"
 G2: 5u" Gold S2: Selective 5u"
 G3: 10u" Gold S3: Selective 10u"
 G4: 15u" Gold S4: Selective 15u"
 G5: 30u" Gold S5: Selective 30u"
 SN: Tin
- ④ Color Insulator
 B: Black
 U: Blue
 G: Gray
- ⑤ Insulator Material
 A: PBT
 B: PA6T
 C: LCP
- ⑥ Packing
 A: Tray
 B: Bag
 T: Tube

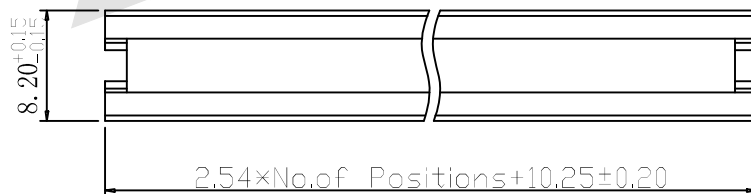
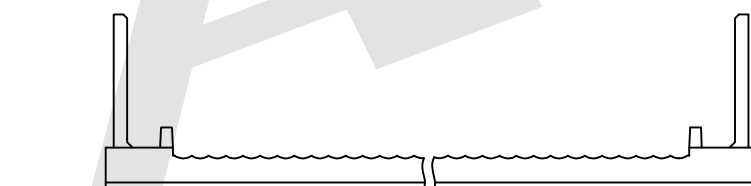
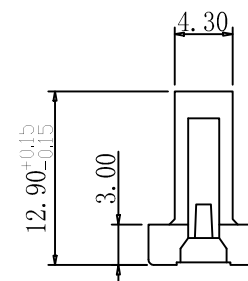
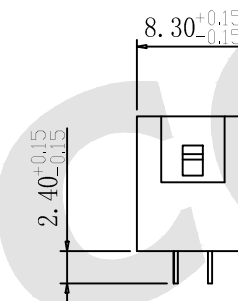
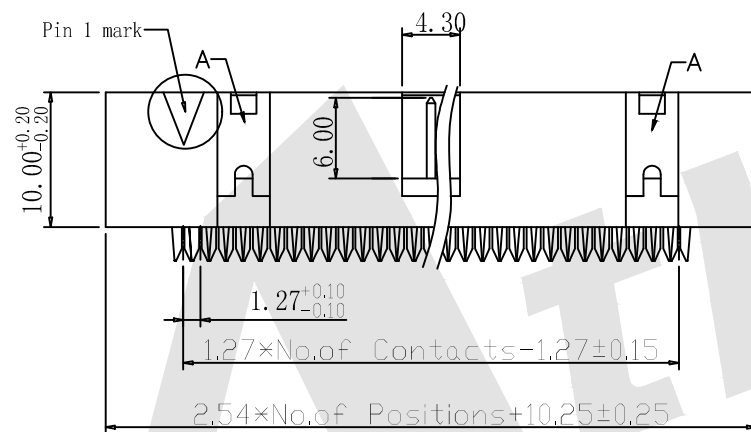
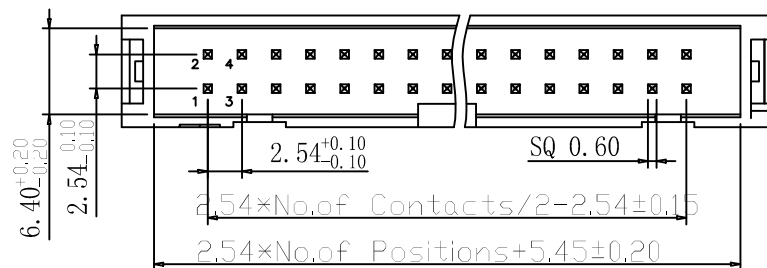

Unless Otherwise specified tolerance
 X. ±0.35 X.XX: ±0.20
 X.X: ±0.25 X.XXX: ±0.15

SCALE: As Shown UNIT: mm
 DRAW ZLA DATE 24/04/2022
 CHECK BobYang DATE 24/04/2022

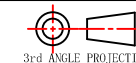

Atkconn® ATKCONN ELECTRONICS CO., LTD
[Http://www.atkconn.com](http://www.atkconn.com)

TITLE: 2.54mm Box Header IDC Type Without Mounting Ears

DRAWING NO: BHDI02-XXXXX

PRODUCT NO: BHDI02-XXXXX

REV	DESCRIPTION	DATE