

HSF



ROHS

**SPECIFICATION**

Current Rating: 1Amp  
 Insulation Resistance: 1000MΩ min  
 Contact Resistance: 20MΩ max  
 Withstand Voltage: 500V AC/DC  
 Operating Temperature: -40°C to +105°C  
 Contact Material: Brass  
 Contact Plating: Au or Sn Over Ni  
 Insulator Material: PA6T+30%GF UL 94V-0

Ordering Code:

BHAM01 - X - X - X - X - X  
 ① ② ③ ④ ⑤ ⑥

- ① Series No:  
 06 08 10 14 16  
 20 24 26 30 32  
 34 40 44 50 60  
 64 80 100
- ② No. of Contacts  
 06 08 10 14 16  
 20 24 26 30 32  
 34 40 44 50 60  
 64 80 100
- ③ Contact Plating:  
 G0:Gold flash S0:Selective  
 G1:3u" Gold S1:Selective 3u"  
 G2:5u" Gold S2:Selective 5u"  
 G3:10u" Gold S3:Selective 10u"  
 G4:15u" Gold S4:Selective 15u"  
 G5:30u" Gold S5:Selective 30u"  
 SN:Tin
- ④ Color Insulator  
 B:Black  
 U:Blue  
 W:White
- ⑤ Insulator Material  
 B:PA6T  
 C:LCP  
 E:PA9T
- ⑥ Packing  
 A:Tray  
 B:Bag  
 T:Tube  
 U:Tube+CAP  
 R:Tape&Reel  
 W:Tape&Reel+CAP
- ⑦ With locating pegs option  
 A:Type A without pegs  
 B:Type B with pegs

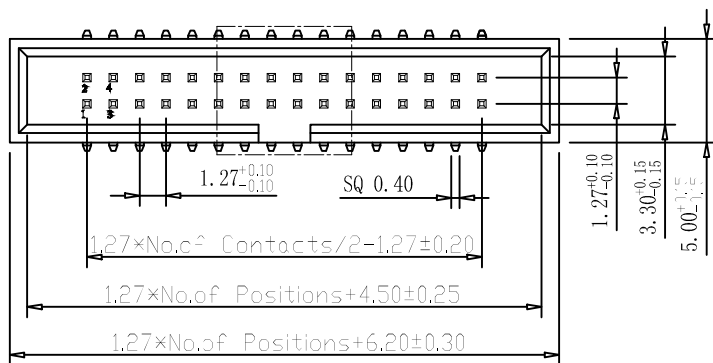

Recommended P.C.B Layout (Top Side)  
 (PCB BOARD TOLERANCE ±0.05)

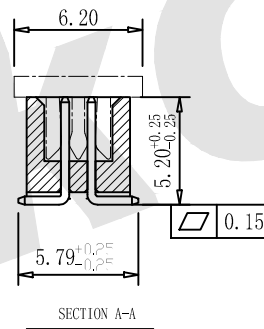
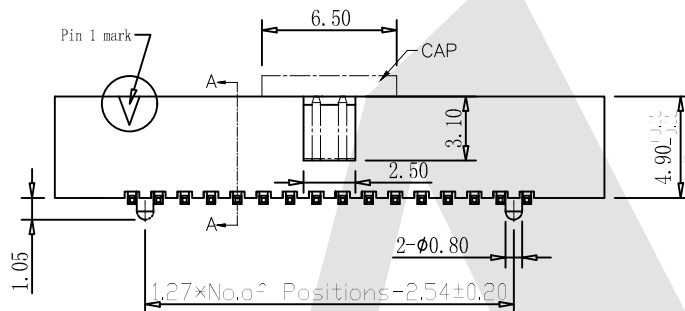
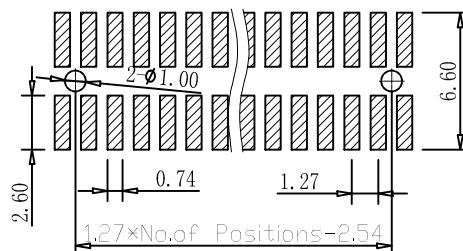

TYPE -A

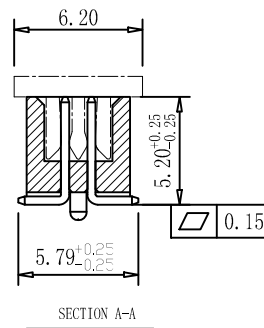
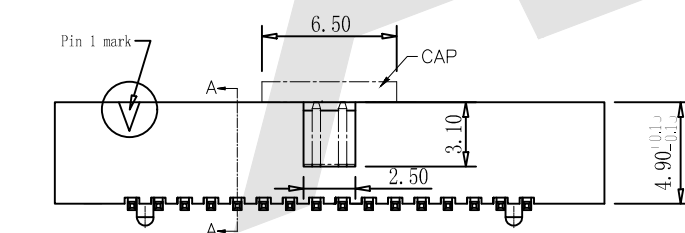

TYPE -B

Unless Otherwise specified tolerance  
 X. ±0.35 X.XX: ±0.20  
 X.X: ±0.25 X.XXX: ±0.15

**Atkconn**® ATKCONN ELECTRONICS CO., LTD  
 Http://www.atkconn.com

SCALE: As Shown UNIT: mm  
 DRAW ZLA DATE 24/04/2022  
 CHECK BobYang DATE 24/04/2022

TITLE:  
 1.27mm Box Header SMT H=4.90 With post

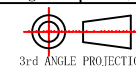

DRAWING NO: BHAM01-XXXXXX  
 PRODUCT NO: BHAM01-XXXXXX

REV	DESCRIPTION	DATE
1		
2		
3		
4		
5		