

Narrow Linewidth Semiconductor Lasers

(MODEL: NLWECL-1080-50-1000-FBG-BTF)

Applications:

- 1. Coherent optical communication**
- 2. LIDAR**
- 3. Optical sensing and detection**
- 4. Seeder for high power lasers**
- 5. RF and microwave photonics**
- 6. Spectroscopy**
- 7. Scientific research**

Features & Functions:

- 1. Frequency-stabilised external-cavity semiconductor laser**
- 2. Center wavelength $1080 \pm 1\text{nm}$**
- 3. Single frequency emission**
- 4. Narrow linewidth**
- 5. Long coherence length**
- 6. Low phase noise & Relative intensity noise (RIN)**
- 7. Excellent power and wavelength stability**
- 8. SMF and PM fiber pigtail options**

performance index:

Electrical and optical characteristics				
Parameter	Min	Typ	Max	Test condition
Center wavelength (nm)	1079	1080	1081	Vacuum
Threshold current (mA)	120	145		
C.w. operating current (mA)		400	450	
Forward coltage (V)		2.2		@100 mA
C.w. output power (mW)		50		CW
SMSR(dB)	45	50		CW
Spectral linewidth (kHz)		<1000		@ white noise
RIN (dBc/Hz)		-140		@ Offset frequency 100 kHz
Polarization extinction ratio (dB)	18	20		
Absolute maximum ratings				
TEC current (A)		2.2		
TEC voltage (V)		3.2		
TEC rated power (W)		3.8		
NTC thermistor resistance (k Ω)		10		@25 $^{\circ}$ C
Thermistor β value (K $^{-1}$)		3950		@25 $^{\circ}$ C
Operating temperature range ($^{\circ}$ C)	0		50	
Storage temperature range $^{\circ}$ C)	-40		85	
Fiber specifications				
Butterfly packaging	14-pin Butterfly packaging			
Fiber type	SM or PM fiber			
Fiber adapter	FC/APC			

Pin connections & module drawing (dimensions in mm):

Contact #	Description	Contact #	Description
1	Thermistor	8	Package
2	Thermistor	9	Package
3	Laser Cathode (-)	10	NC
4	PD Anode	11	Laser Anode (+)
5	PD Cathode	12	NC
6	TEC +	13	Laser Anode (+)
7	TEC -	14	NC

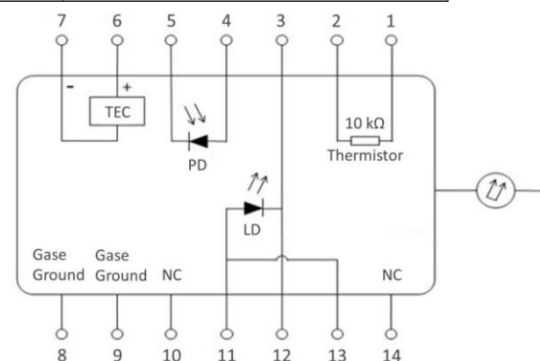
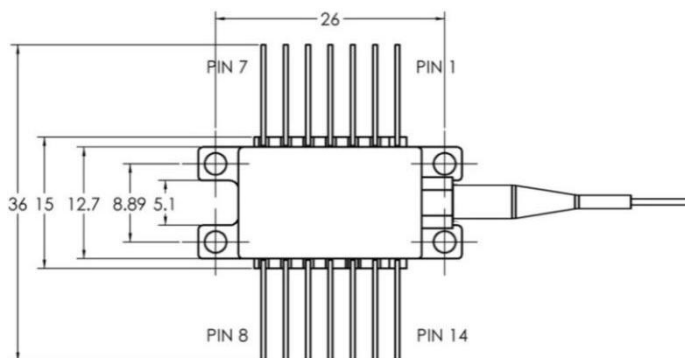

Ordering Information:

MODEL: NLWECL-XXXX-OP-NLW-FBG-BTF

