

Narrow Linewidth Semiconductor Laser Modules

(MODEL: NLWECL-1064-50-500-FBG-MOD-PM)

Applications:

1. Coherent optical communication
2. LIDAR
3. Optical sensing and detection
4. Seeder for high power lasers
5. RF and microwave photonics
6. Spectroscopy
7. Scientific research

Features & Functions:

1. Frequency-stabilised external-cavity semiconductor laser
2. Center wavelength $1064 \pm 1\text{nm}$
3. Single frequency emission
4. Narrow linewidth
5. Long coherence length
6. Low phase noise & Relative intensity noise (RIN)
7. Excellent power and wavelength stability
8. PM fiber pigtail

performance index:

Electrical and optical characteristics				
Parameter	Min	Typ	Max	Test condition
Center wavelength (nm)	1063	1064	1065	Vacuum
Threshold current (mA)	120	145		
C.w. operating current (mA)		400	450	
Forward coltage (V)		2.2		@100 mA
C.w. output power (mW)		50		CW
SMSR(dB)	45	50		CW
Spectral linewidth (kHz)		<500		@ white noise
RIN (dBc/Hz)		-140		@ Offset frequency 100 kHz
Polarization extinction ratio (dB)	18	20		
Absolute maximum ratings				
TEC current (A)		2.2		
TEC voltage (V)		3.2		
TEC rated power (W)		3.8		
NTC thermistor resistance (k Ω)		10		@25 $^{\circ}$ C
Thermistor β value (K $^{-1}$)		3950		@25 $^{\circ}$ C
Operating temperature range ($^{\circ}$ C)	0		50	
Storage temperature range $^{\circ}$ C)	-40		85	
Fiber specifications				
Butterfly packaging	14-pin Butterfly packaging			
Fiber type	PM fiber			
Fiber adapter	FC/APC			

Pin connections & module drawing (dimensions in mm):

Contact #	Description	Contact #	Description
1	Thermistor	8	Package
2	Thermistor	9	Package
3	Laser Cathode (-)	10	NC
4	PD Anode	11	Laser Anode (+)
5	PD Cathode	12	NC
6	TEC +	13	Laser Anode (+)
7	TEC -	14	NC

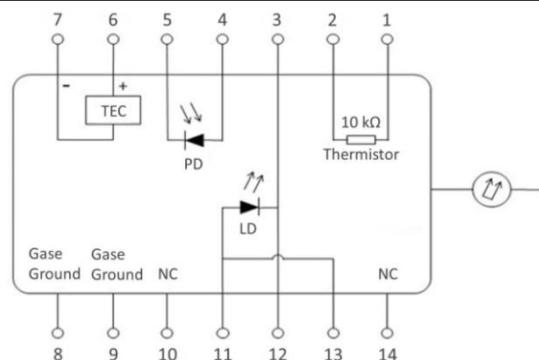
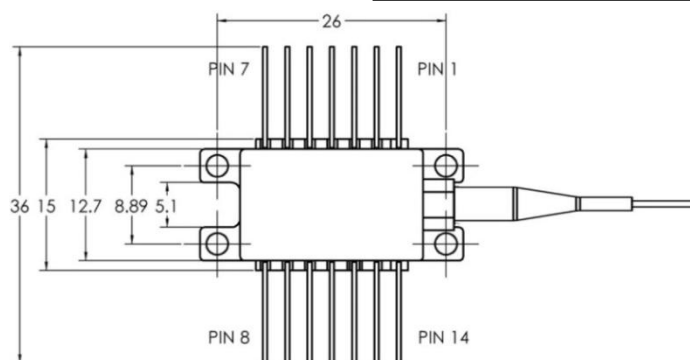

Ordering Information:

MODEL: NLWECL-XXXX-OP-NLW-FBG-MOD

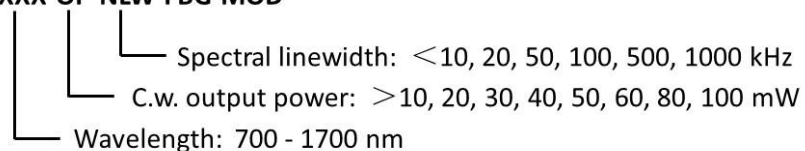

地址: 吉林省长春市北湖科技开发区明溪路 1759 号 A331 室 邮编: 130102

Add: Room A331, No.1759 Mingxi Road, Changchun, Jilin, China Post Code:130102

Website: <http://www.acephoton.com>

Tel: +86-431-81087896

Fax: +86-431-81087896