

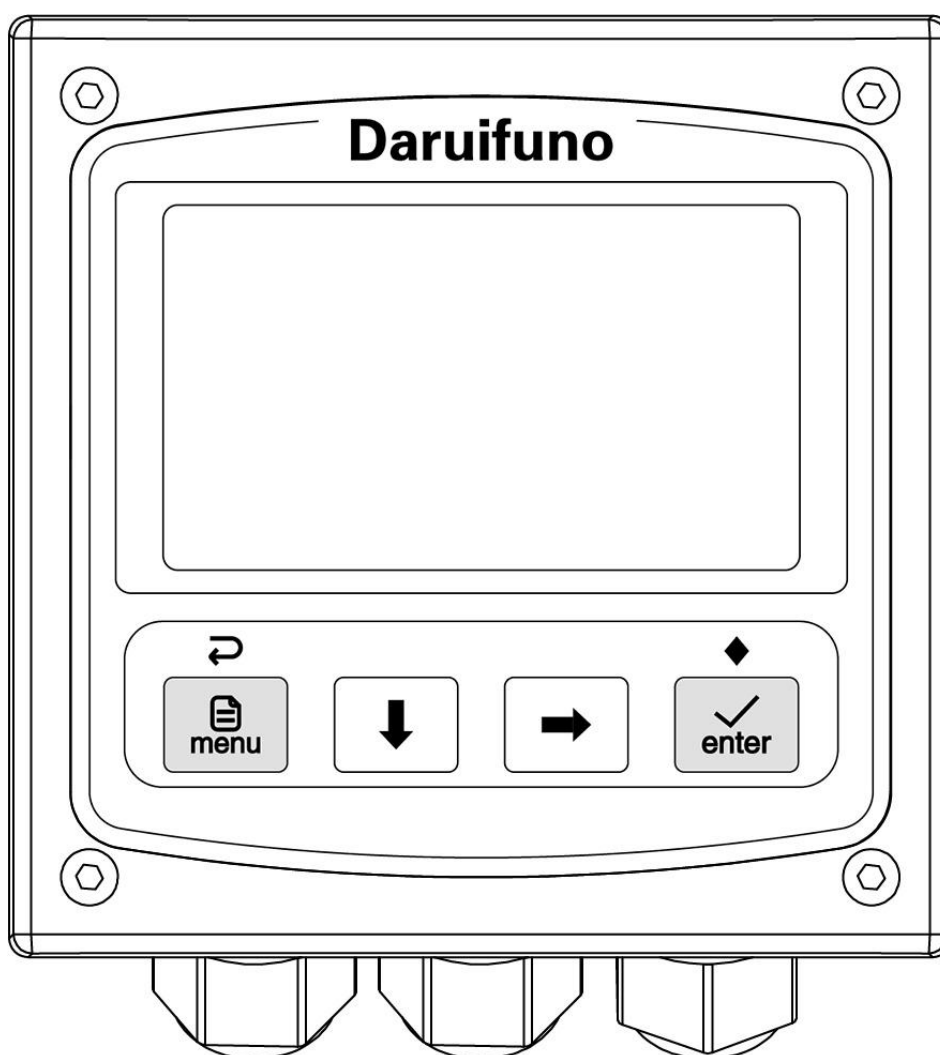

Online pH/ORP Controller

User Manual



Model: APX1-G2

Version 01.11

CONTENTS

Chapter 1 Overview	1
Chapter 2 Mechanical Installation	2
2.1 Dimension	2
2.2 Installation	2
Chapter 3 Electrical Installation	3
3.1 Power Connection	3
3.2 Terminal Definition	4
Chapter 4 User Interface	5
4.1 Panel Button	5
4.2 Display Screen	6
Chapter 5 Menu Description	7
5.1 Probe Setting	7
5.2 Alarm Setting	8
5.3 Current Setting	9
5.4 Comm. Setting	9
Appendix	10
ModBus Register Introduction	10
Menu Structure Diagram	11

Chapter 1 Overview

The online pH/ORP controllers are suitable for continuous monitoring of pH or ORP values of aqueous solutions in various industries.

1.1 Technical Parameters

Display Range	pH: 0~14pH
	ORP: -2000mV~2000mV
	Temp.: -10~+150°C
Resolution	pH: 0.01pH ORP: 1mV Temp.: 0.1°C
Accuracy	pH: ±0.02pH, ORP: ±2mV
Temp. Compensation	NTC10K/PT1000 automatic or manual, Converted to 25°C
Relay Control	Two SPST relays, contact capacity: 3A 250V AC
	Control Type: main value control / temp. Control / wash control / internal temp. alarm
Current Output	Two active 4~20mA or 0~20mA, max. Load 1000 Ω
	Corresponding channel: main value/temp.
Comm. Interface	A RS485, support MODBUS-RTU protocol and JSON text format
Solution Grounding	It can eliminate the leakage interference of part of the solution
Calibration Method	pH: 3-point calibration/5-point calibration, ORP: 2-point calibration quick calibration menu available
Display Screen	3.2 inch graphic LCD display
Configuration Information	Power failure protection, parameters are retained indefinitely
Operating Environment	0~+60°C, relative humidity 0~95%, no condensation
Storage Environment	-20~+70°C, relative humidity 0~55%, no condensation
Power Supply	100~240VAC or 18~36VDC, 3W Max
Installation Method	Panel mounting
Instrument Dimension	100*100*120 (unit: mm)
Protection Grade	IP66
Instrument Weight	About 500g

Chapter 2 Mechanical Installation

2.1 Dimension

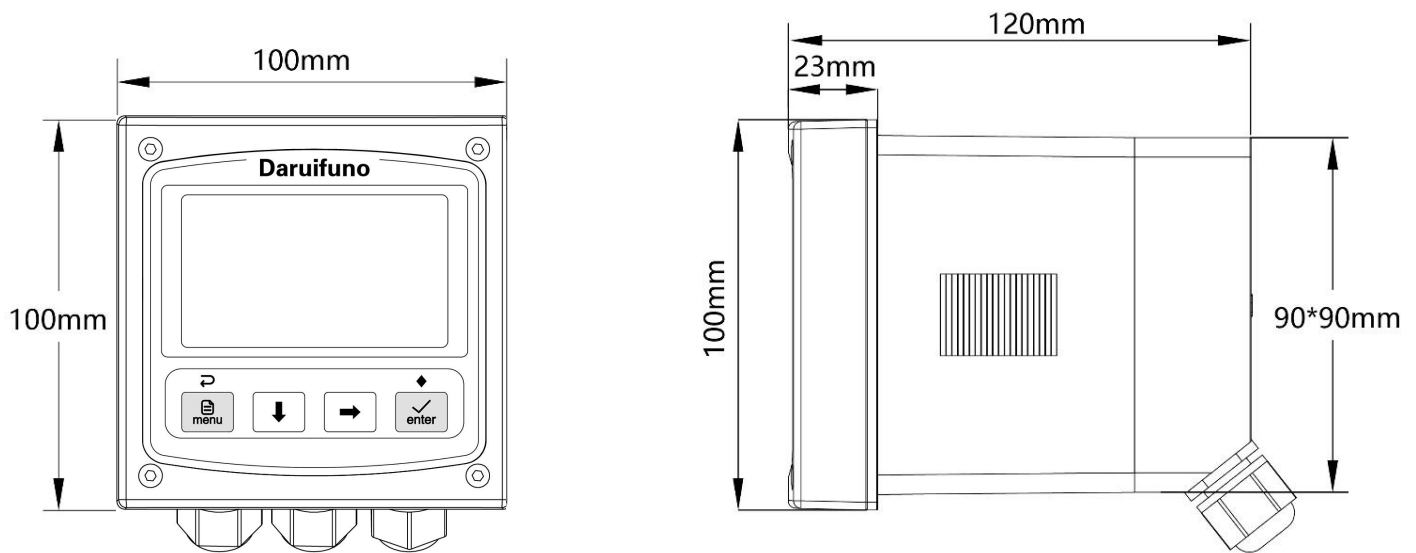

Figure 2-1 Instrument dimension

2.2 Installation

When the controller is selected for panel mounting, the user passes the fixing clips through the back of the instrument until it is tightened, and the mounting dimensions and diagram are shown below:

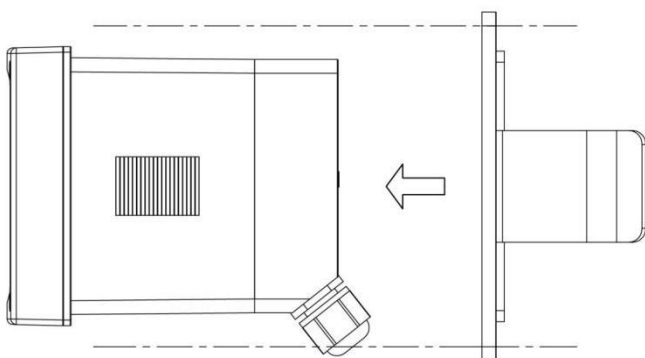

Figure 2-2 Panel mounting

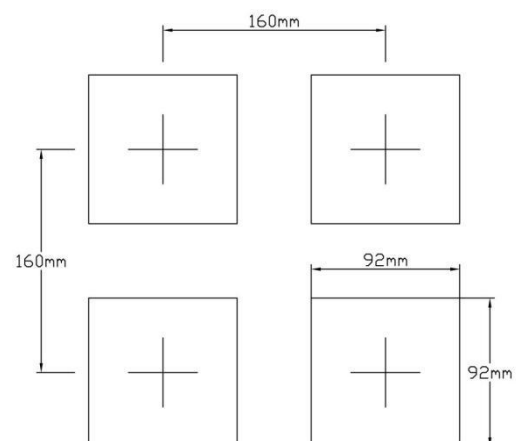

Figure 2-3 The minimum opening spacing

Chapter 3 Electrical Installation

3.1 Power Connection

After unscrewing the screws on the back of the meter, remove the cover and see the terminal blocks. According to the power supply type of the instrument, access 100~240VAC or 18~36VDC.

Note: Before connecting AC power, be sure to cut off the power supply

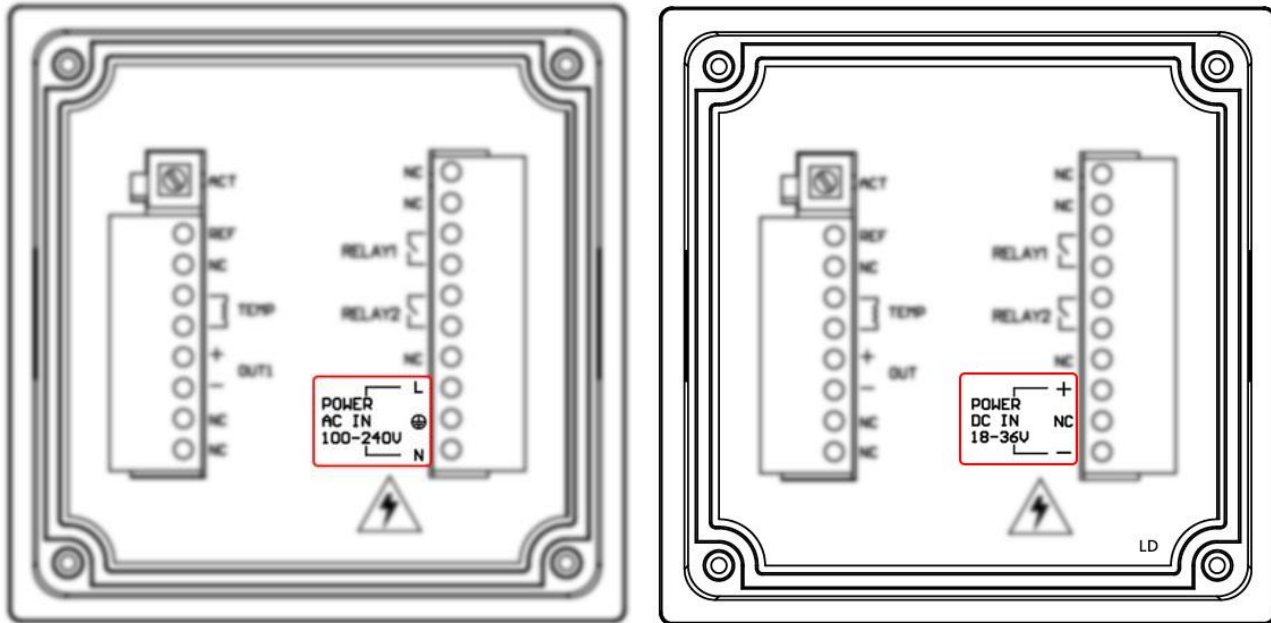

Figure 3-1 Two types of power terminals

Two kinds of power terminals are defined in the Table:

POWER AC IN 100-240V	L	AC power LIVE wire	POWER DC IN 18-36V	+	DC power positive
	⊕	AC power ground wire		NC	Floating terminal
	N	AC power NEUTRAL wire		-	DC power negative

3.2 Terminal Definition

The electrode cable is connected to the ACT, REF, SG⁽¹⁾,TEMP terminals, and the rest are connected according to actual needs.

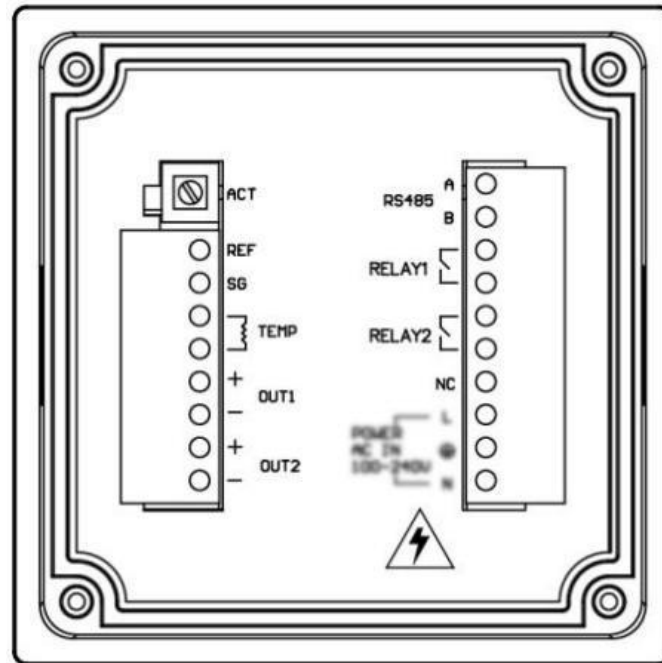

Figure 3-2 terminal blocks

The terminal locations and names are shown in the table below:





ACT		pH(ORP) probe indication	RS485	A	RS485 signal D+(A)
REF		pH(ORP) probe reference		B	RS485 signal D-(B)
SG ⁽¹⁾		pH probe ground terminal	RELAY1		Relay 1 contact
TEMP		Temp. probe input terminal			
		Temp. probe input terminal	RELAY2		Relay 2 contact
OUT1	+	Current 1 Output positive			
	-	Current 1 Output negative	NC		Floating terminal
OUT2	+	Current 2 Output positive			
	-	Current 2 Output negative			

Note:

(1) When connecting the electrode without SG cable, short-connect REF to the SG terminal.

Chapter 4 User Interface

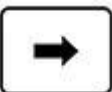

4.1 Panel Button

Button	Function
	<p>In the main menu, long press to return to the measurement mode</p> <p>In the sub menu, return to the previous menu</p> <p>When setting the value, abandon the modification and return to the previous menu</p> <p>During calibration, cancel the calibration process</p> <p>In measurement mode, long press to enter the main menu</p>
	<p>In measure mode, switch between two secondary display modes</p> <p>In the menu, move the cursor down</p> <p>When setting the value, subtract 1 from the value, or to change the sign bit</p>
	<p>In measurement mode, switch between two measurement value display modes (only pH measurement mode is available)</p> <p>In the menu, move the cursor up</p> <p>When setting the value, move the cursor right</p>
	<p>In measurement mode, long press to open the quick calibration menu</p> <p>In the menu, enter the sub menu or the item selected by the cursor</p> <p>When setting the parameter (value or option), save the setting and return to the previous menu</p>

4.2 Display Screen

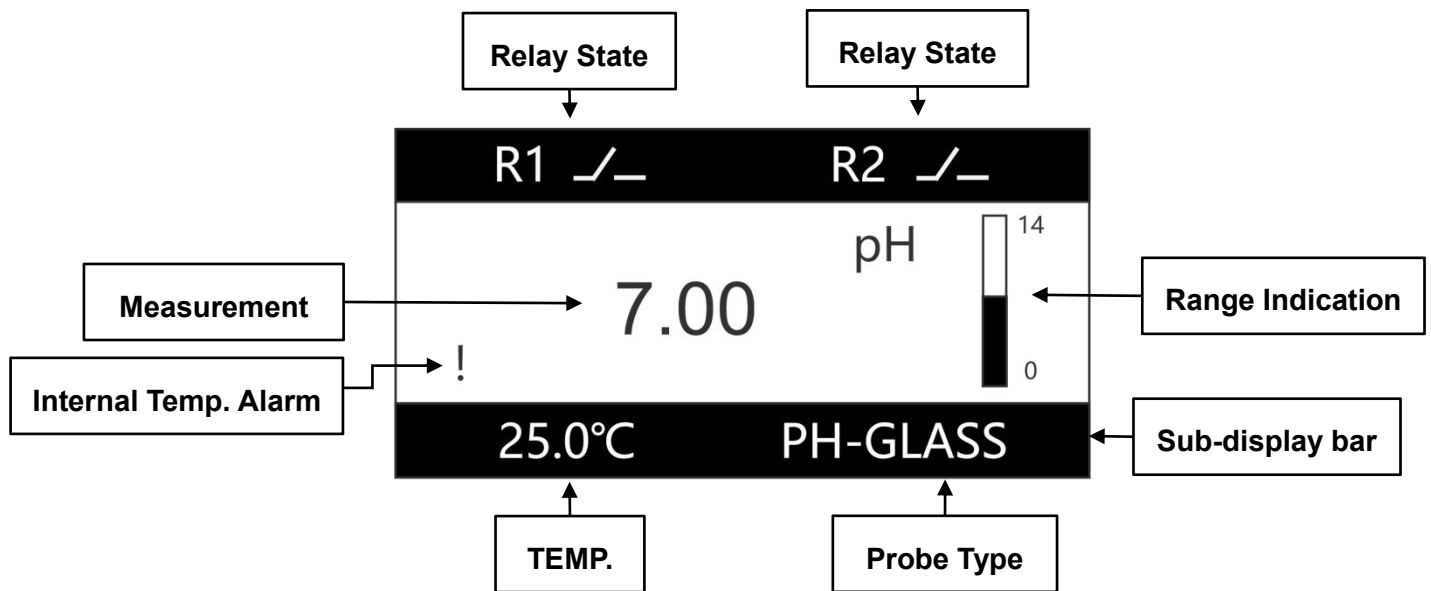
The meter normally displays the measurement interface after power-on. The specific information is as follows:



- **Relay state:** indicate the current relay state: on or off
- **Measurement:** display the current pH/ORP value, if “ > ” symbol appears in front of the value, it means the measurement is out of the range. In the pH measurement mode, press the button  to switch “ pH measurement ” to “ mV/pH measurement ”
- **Range indication:** Indicates the ratio of the current measured value to the range.
- **Internal Temp. Alarm:** When the internal temperature of the instrument exceeds 50°C, the measurement interface will appear “ ! ”, reminding users to increase ventilation and heat dissipation measures.
- **Sub-display bar:** Press  under the measurement interface to switch the sub-display bar information.
- **Temperature:** The temp. value is not displayed when the temp. probe is not connected.
- **Probe Type:** Display the currently selected probe type.
 - “ PH-GLASS ” means “ pH glass probe ”
 - “ PH-ANT ” means “ pH antimony probe ”
 - “ ORP ” means “ ORP probe ”

Chapter 5 Menu Description

In the measurement interface, long press the



button to enter the menu. This chapter describes the main features.

5.1 Probe Setting

Perform sensor calibration and view sensor status.

After the probe is connected to the controller, it needs to be calibrated first due to the error between the signal of the actual electrode and the standard.

● pH Calibration

In the menu [Select Probe], choose [pH-glass probe] or [pH-antimony probe].

➤ Three-point calibration

In the menu [CAL Mode], choose [Three Point CAL]

1. Preparation before calibration

- pH 4.01, 6.86, 9.18 standard solution⁽¹⁾
- Deionized cleaning solution and absorbent paper

2. Zero Calibration

(1) Clean the probe with deionized cleaning solution, dry it with absorbent paper and put it into a standard solution with pH 6.86;

(2) After the measured value is stable, select “ 6.86pH CAL ” to start calibration;

3. Slope 1 Calibration

(1) Clean the probe with deionized cleaning solution, dry it with absorbent paper and put it into a standard solution with pH 4.01;

(2) After the measured value is stable, select “ 4.01pH CAL ” to start calibration;

4. Slope 2 Calibration

(1) Clean the probe with deionized cleaning solution, dry it with absorbent paper and put it into a standard solution with pH 9.18;

(2) After the measured value is stable, select “ 9.18pH CAL ” to start calibration;

➤ Five-point calibration

In the menu [CAL Mode], choose [Five Point CAL]

1. Prepare solutions of five pH values

2. Calibrate in the order of 1pH -> 4pH -> 7pH -> 10pH -> 12pH. The calibration values can be modified, but the modified calibration values should remain in increasing order from point one to point five.

➤ Set the converted temperature

Set the temperature compensation relationship of the pH value of the solution, and the measured value is the value when converted to 25 °C.

- ORP Calibration

1. Preparation before calibration

- In the menu [Select Probe], select [ORP Probe]
- ORP 86mV, 256mV standard solution⁽¹⁾
- Deionized cleaning solution and absorbent paper

2. Zero Calibration

- (1) Clean the probe with deionized cleaning solution, dry it with absorbent paper and put it into a standard solution with ORP 86mV;
- (2) After the measured value is stable, select " 86mV CAL " to start calibration;

3. Slope Calibration

- (1) Clean the probe with deionized cleaning solution, dry it with absorbent paper and put it into a standard solution with ORP 256mV;
- (2) After the measured value is stable, select " 256mV CAL " to start calibration;

Note:

(1) If there is a standard solution with other values, the calibration value can be modified to the actual value after selecting the calibration value.

- Quick Calibration Mode

Press and hold the button  on the measurement interface to open the Quick calibration menu. At this time, the key function prompt will appear in the sub-display bar, and you can press the key below the prompt to perform the corresponding operation.

5.2 Alarm Setting

- **Control function**

When [Main value Control] or [Temp. Control] is selected in the [Function Set] menu, the relay is a control output relay. When [Main value Control] is selected, the relay is controlled by the main measurement value; When [Temp. Control] is selected, the relay is controlled by the temp. measurement.

When " On Value " > " Off Value " are set in the menu, the relay is a high alarm control.

When " On Value " < " Off Value " are set in the menu, the relay is low alarm control.

- **Wash relay**

When [Wash Relay] is selected in the [Function Set] menu, the relay is in the wash output state, and the relay will on and off in the set cycle for wash control.

When [Hold] is selected for [Wash State], when cleaning, the measurement display value remains unchanged before the relay is operated.

When [Constant] is selected for [Wash State], the measurement value is the real-time value of continuous measurement.

- **Internal temp. alarm**

When [Internal temperature alarm] is selected in the menu [Function set], the relay will close when the internal temperature of the instrument exceeds 50 °C.

5.3 Current Setting

Use a current signal to output the measured value.

Set the measured value for the current in [Channel Select].

The measured values corresponding to the current output “ 20mA ” and “ 0mA/4mA ” are set in “ Max. Value ” and “ Min. value ”, respectively.

5.4 Comm. Setting

Use RS485 interface to output the measured value.

When [ModBus] is selected for [Comm. Protocol], Modbus standard comm. is used. Refer to the appendix for the description of relevant registers.

When [Json] is selected for [Comm. Protocol], the instrument will send the measured value every one minute in text format.

Chapter 5 Menu Description

ModBus Register Introduction

The instrument acts as a slave on the network and supports the Modbus RTU communication protocol.

The main unit can use function code 04 to read the measurement results.

The parameters corresponding to the register address are defined as follows:

Register Start Address	Function Code	Parameters	Number of Registers	Data Format
0	04	Temp value (°C)	2	32-bit floating point default CDAB(3412)
2	04	pH value	2	32-bit floating point default CDAB(3412)
4	04	ORP value(mV)	2	32-bit floating point default CDAB(3412)

Menu Structure Diagram

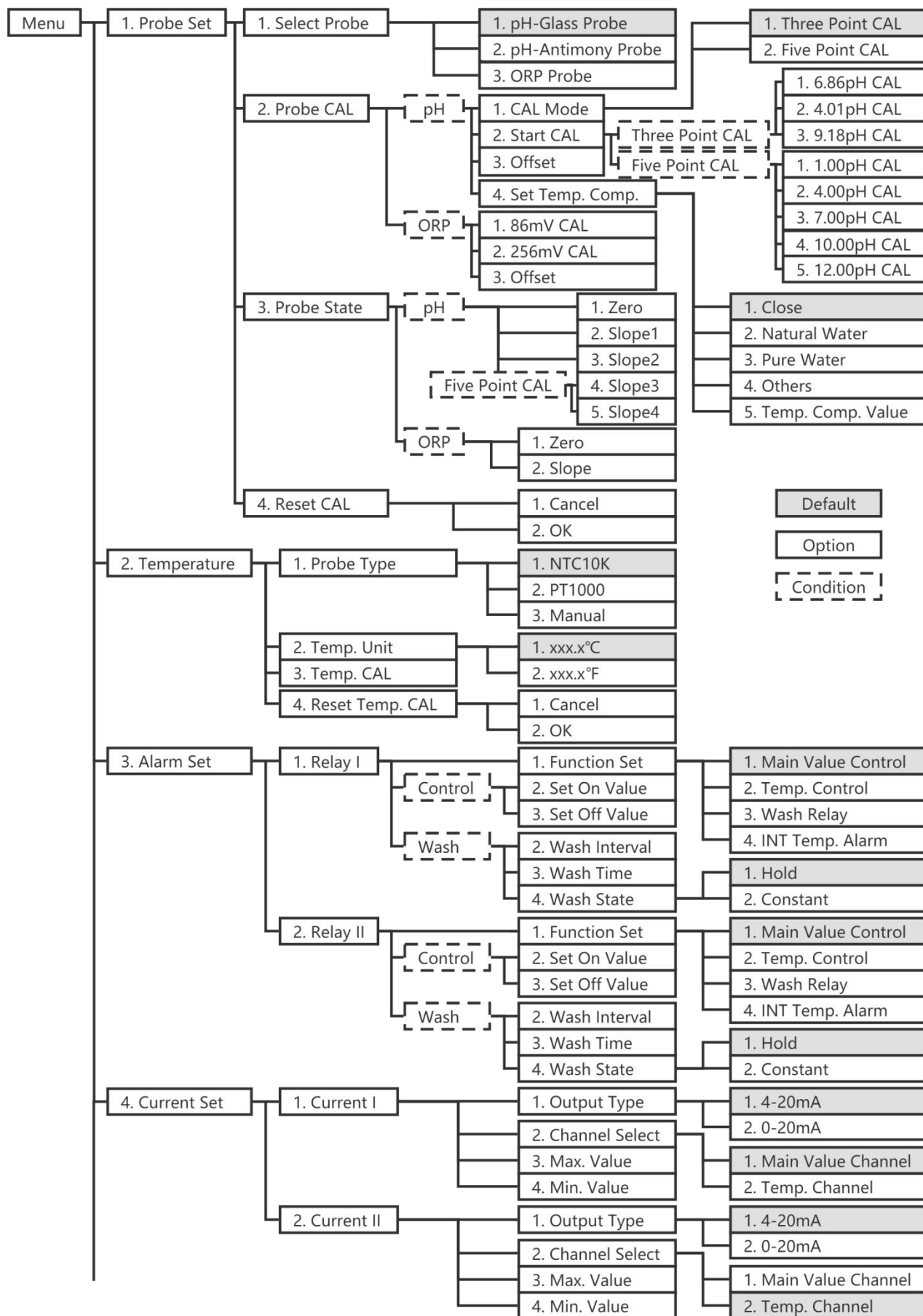

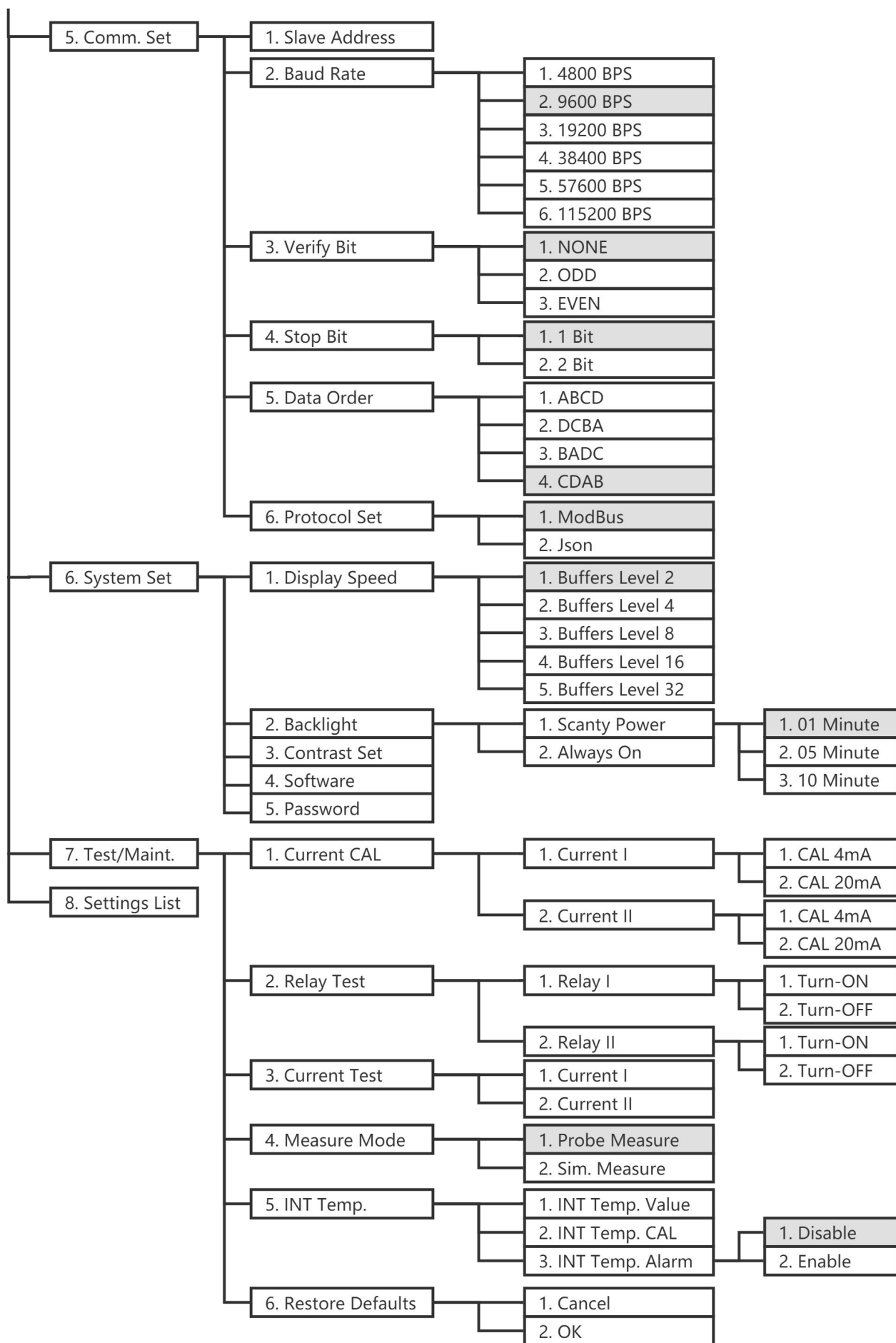



Suzhou Delfino Environmental Technology CO., Ltd

Tel: +86-0512-65165265

Phone: +86-18013144571(whatsapp)

Website: www.daruifuno.com

Email: info@daruifuno.com