

Pressure relief valve, pilot operated

RE 25751/10.05
Replaces: 05.02

1/8

Types ZDB and Z2DB

Nominal size 6
Component series 4X
Maximum operating pressure 315 bar
Maximum flow 60 L/min

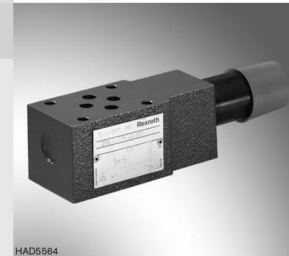

Overview of contents

Contents	Page
Features	1
Ordering details	2
Preferred types	2
Symbols	3
Function, section	3
Technical data	4
Characteristic curves	4
Unit dimensions	5 to 7

Features

- Sandwich plate valve
- Connection location to DIN 24340 form A (**without** locating pin), (standard)
- Connection location to ISO 4401-03-02-0-94 (**with** locating pin), (ordering code .../60)
- 4 pressure stages
- 5 circuit options
- With 1 or 2 pressure valve cartridges
- 4 adjustment elements for pressure adjustment, optional
 - Rotary knob
 - Sleeve with hexagon and protective cap
 - Lockable rotary knob with scale
 - Rotary knob with scale

For information regarding the available spare parts see:
www.boschrexroth.com/spc

Ordering details

Z	DB	6	-4X/	V	*
Sandwich plate = Z	1 pressure valve cartridge = No code (only for versions „VA“, „VB“ and „VP“)	2 pressure valve cartridges = 2 (only for versions „VC“ and „VD“)			Further details in clear text
Pressure relief valve = DB		Nominal size 6 = 6			No code = Without locating pin /60 ²⁾ = With locating pin
Relief function from – to:					Seal material V = FKM seals (other seals on request)
A – T = VA					Attention! The compatibility of the seals and pressure fluid is to be taken into account!
P – T = VP					Pressure stage
B – T = VB					50 = Settable pressure up to 50 bar
A – T and B – T = VC					100 = Settable pressure up to 100 bar
A – B and B – A = VD					200 = Settable pressure up to 200 bar
					315 = Settable pressure up to 315 bar
Adjustment element for pressure adjustment					4X = Component series 40 to 49 (40 to 49: unchanged installation and connection dimensions)
Rotary knob = 1					
Sleeve with hexagon and protective cap = 2					
Lockable rotary knob with scale = 3 ¹⁾					
Rotary knob with scale = 7					

¹⁾ H key under Material No. **R900008158** is included within the scope of supply

²⁾ Locating pin ISO 8752-3x8-St, Material No. **R900005694** (separate order)

Further standard components can be found within the EPS (Standard Price List).

Preferred types (readily available)

Type ZDB	Material No.
ZDB 6 VA2-4X/100V	R900409889
ZDB 6 VA2-4X/200V	R900409886
ZDB 6 VA2-4X/315V	R900409893
ZDB 6 VB2-4X/200V	R900409854
ZDB 6 VB2-4X/315V	R900409896
ZDB 6 VP2-4X/50V	R900409847
ZDB 6 VP2-4X/100V	R900409933
ZDB 6 VP2-4X/200V	R900409844
ZDB 6 VP2-4X/315V	R900409898

Type Z2DB	Material No.
Z2DB 6 VC2-4X/200V	R900411312
Z2DB 6 VC2-4X/315V	R900411318
Z2DB 6 VD2-4X/100V	R900411317
Z2DB 6 VD2-4X/200V	R900411314
Z2DB 6 VD2-4X/315V	R900411357

Symbols (1) = valve side, (2) = subplate side)

Type ZDB 6 VA...

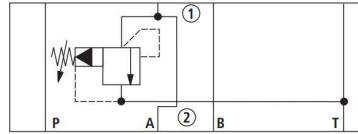

Type ZDB 6 VB...

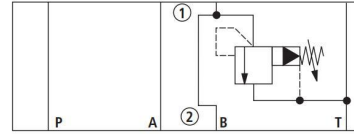

Type ZDB 6 VP...

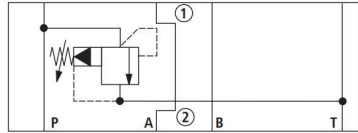

Type Z2DB 6 VC...

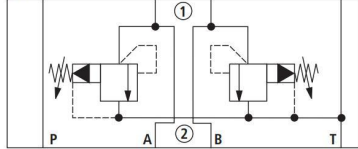

Type Z2DB 6 VD...

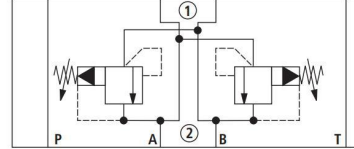

Function, section

Pressure valve types ZDB and Z2DB are pilot operated pressure relief valves and of sandwich plate design. They are used to limit the pressure within a hydraulic system. They basically consist of the housing (7), together with one or two pressure relief valve cartridges. The system pressure is set by means of adjustment element (4).

At rest, the valve is closed. Pressure in port A acts on the spool (1). At the same time pressure passes through orifice (2) onto the spring loaded side of spool (1) and via orifice (3) to the pilot poppet (6). If the pressure in port A rises above the value set on spring (5), then the pilot poppet (6) opens. Fluid can now flow from the spring loaded side of the spool (1), then via orifice (3), and channel (8) into port T. The resulting pressure drop then moves the spool (1) thereby opening the connection A to T, while maintaining the pressure set at spring (5). Pilot oil return from the two spring chambers is taken externally via port T.

Type ZDB 6 VA2...

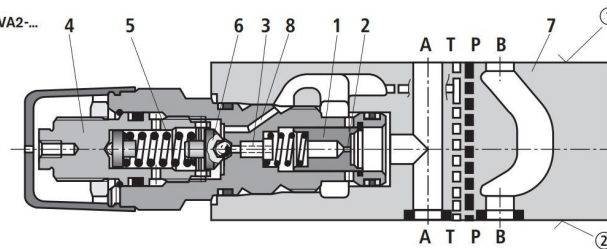

Technical data (for applications outside these parameters, please consult us!)**General**

Weight	Type ZDB 6	kg	Approx. 1
	Type Z2DB 6	kg	Approx. 1,2
Installation			Optional
Ambient temperature range		°C	-20 to +80

Hydraulic

Maximum operating pressure	bar	315
Maximum settable pressure	bar	50; 100; 200; 315
Maximum back pressure (port Y)	bar	315 (take the max. tank pressure of the built-on valve/ directional valve into account!)
Maximum flow	L/min	60
Pressure fluid	Mineral oil (HL, HLP) to DIN 51524; fast bio-degradable pressure fluids to VDMA 24568 (also see RE 90221); HETG (rape seed oil); HEPG (polyglycols); HEES (synthetic ester); other pressure fluids on request	
Pressure fluid temperature range	°C	-20 to +80
Viscosity range	mm ² /s	10 to 800
Max. permissible degree of pressure fluid contamination Cleanliness class to ISO 4406 (c)	Class 20/18/15 ¹⁾	

¹⁾ The cleanliness class stated for the components must be adhered to in hydraulic systems. Effective filtration prevents faults from occurring and at the same time increases the components service life.

For the selection of filters see data sheets RE 50070, RE 50076, RE 50081, RE 50086 and RE 50088.

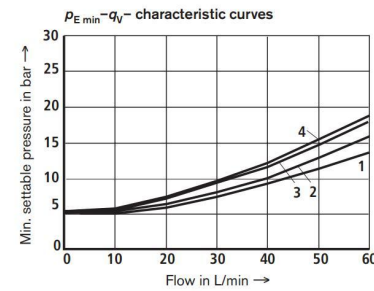
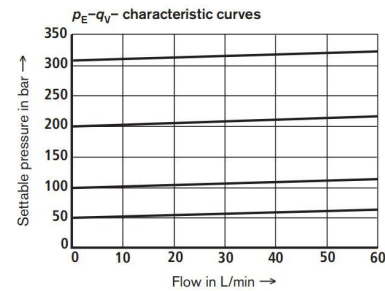
Characteristic curves (measured with HLP46 and $\vartheta_{oil} = 40 \text{ °C} \pm 5 \text{ °C}$)

- 1 VD (A to B)
- 2 VA
- 3 VB, VC
- 4 VP, VD

The characteristic curves are valid for an outlet pressure = zero over the entire flow range!

Unit dimensions: type ZDB 6 VA... (nominal dimensions in mm)

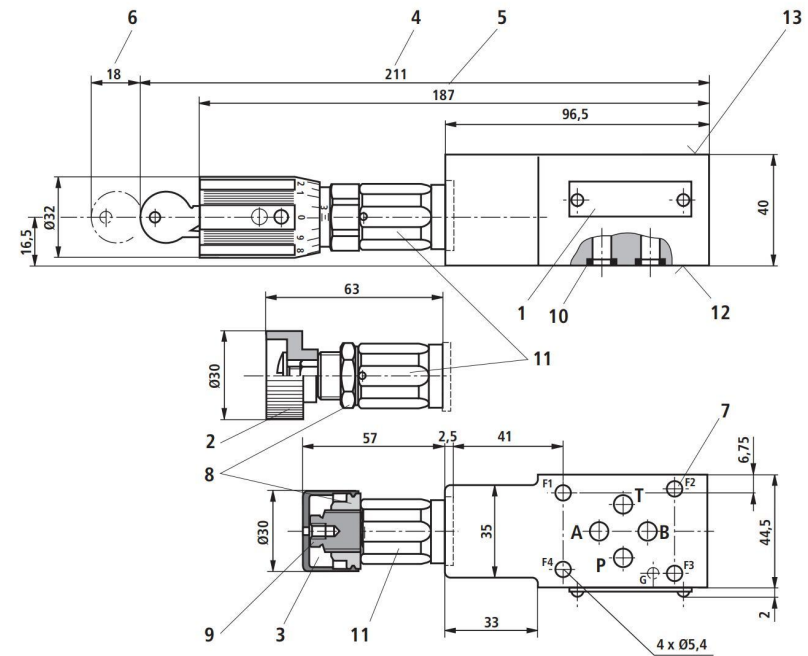

- 1 Name plate
- 2 Adjustment type "1"
- 3 Adjustment type "2"
- 4 Adjustment type "3"
- 5 Adjustment type "7"
- 6 Space required to remove the key
- 7 Valve fixing screw holes
- 8 Locknut A/F24, tightening torque $M_A = 10^{+5}$ Nm
- 9 Hexagon A/F10
- 10 Identical seal rings for ports A, B, P, T (subplate side)
- 11 Hexagon 24A/F, tightening torque $M_A = 50$ Nm
- 12 Subplate side – connection location to DIN 24340 form A (without locating pin), or ISO 4401-03-02-0-94 (with locating pin $\varnothing 3 \times 5$ mm deep for locating pin ISO 8752-3x8-St, Material No. **R900005694**, separate order)
- 13 Valve side – connection location to DIN 24340 form A (without locating pin), or ISO 4401-03-02-0-94 (with locating pin $\varnothing 4 \times 4$ mm deep)

Valve fixing screws (separate order)

- 4 S.H.C.S. ISO 4762 - M5 - 10.9-fIZn-240h-L
Friction co-efficient $\mu_{total} = 0.09$ to 0.14;
Tightening torque $M_A = 7.4$ Nm $\pm 10\%$,
or
- 4 S.H.C.S. ISO 4762 - M5 - 10.9
Friction co-efficient $\mu_{total} = 0.12$ to 0.17,
Tightening torque $M_A = 8.1$ Nm $\pm 10\%$

Unit dimensions: type ZDB 6 VB... and type ZDB 6 VP... (nominal dimensions in mm)

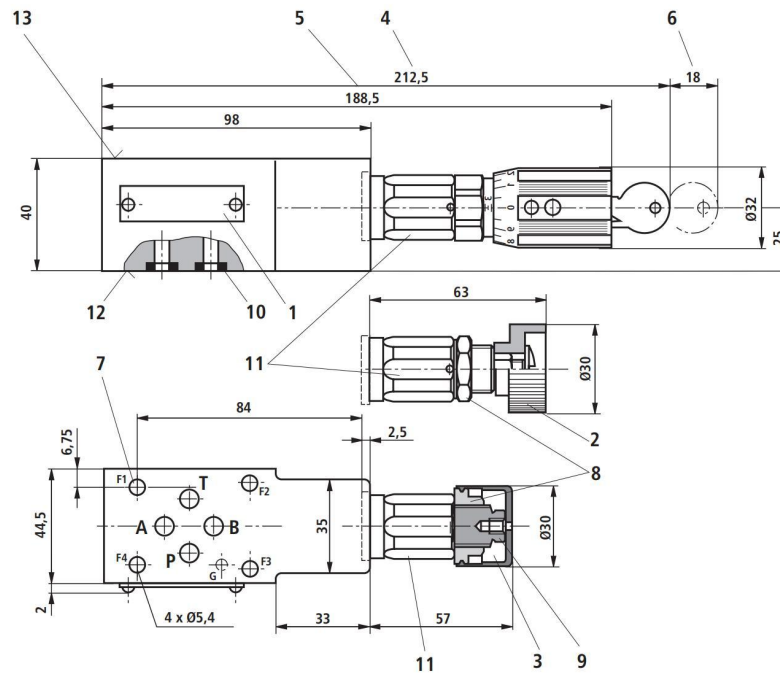

- 1 Name plate
- 2 Adjustment type "1"
- 3 Adjustment type "2"
- 4 Adjustment type "3"
- 5 Adjustment type "7"
- 6 Space required to remove the key
- 7 Valve fixing screw holes
- 8 Locknut 24A/F, tightening torque $M_A = 10^{+5}$ Nm
- 9 Hexagon 10A/F
- 10 Identical seal rings for ports A, B, P, T (subplate side)
- 11 Hexagon 24A/F, tightening torque $M_A = 50$ Nm
- 12 Valve side - connection location to DIN 24340 form A (without locating pin), or ISO 4401-03-02-0-94 (with locating pin $\varnothing 3 \times 5$ mm deep for locating pin ISO 8752-3x8-St, Material No. **R900005694**, separate order)
- 13 Valve side - connection location to DIN 24340 form A (without locating pin), or ISO 4401-03-02-0-94 (with locating pin $\varnothing 4 \times 4$ mm deep)

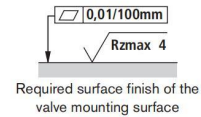

Valve fixing screws (separate order)

- 4 S.H.C.S. ISO 4762 - M5 - 10.9-f1Zn-240h-L
Friction co-efficient $\mu_{total} = 0.09$ to 0.14 ;
Tightening torque $M_A = 7.4$ Nm $\pm 10\%$,
or
- 4 S.H.C.S. ISO 4762 - M5 - 10.9
Friction co-efficient $\mu_{total} = 0.12$ to 0.17 ,
Tightening torque $M_A = 8.1$ Nm $\pm 10\%$

Unit dimensions: type Z2DB 6 VC... and type Z2DB 6 VD... (nominal dimensions in mm)

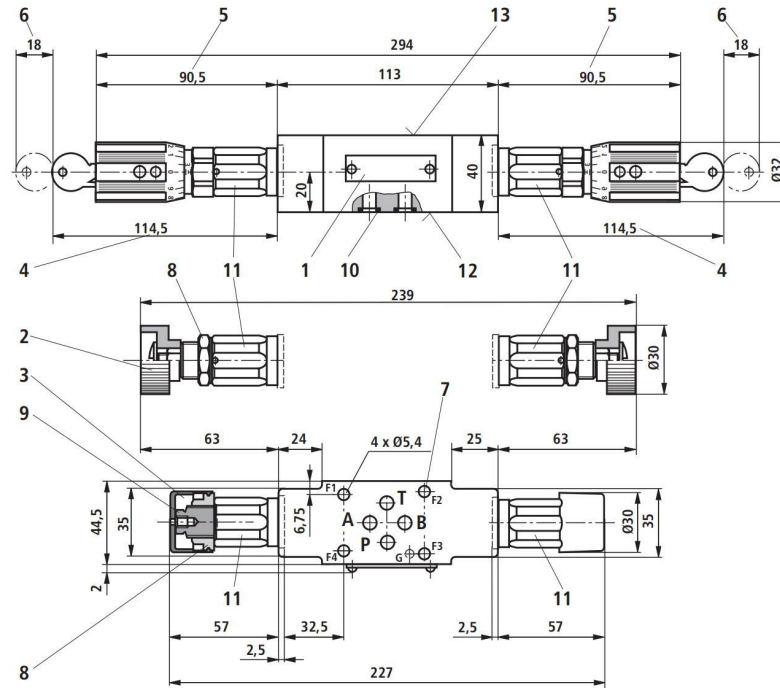

- 1 Name plate
- 2 Adjustment type "1"
- 3 Adjustment type "2"
- 4 Adjustment type "3"
- 5 Adjustment type "7"
- 6 Space required to remove the key
- 7 Valve fixing screw holes
- 8 Locknut 24A/F, tightening torque $M_A = 10^{+6}$ Nm
- 9 Hexagon 10A/F
- 10 Identical seal rings for ports A, B, P, T (valve side)
- 11 Hexagon 24A/F, tightening torque $M_A = 50$ Nm
- 12 Subplate side – connection location to DIN 24340 form A (without locating pin), or ISO 4401-03-02-0-94 (with locating pin $\varnothing 3 \times 5$ mm deep for locating pin ISO 8752-3x8-St, Material No. **R900005694**, separate order)
- 13 Valve side – connection location to DIN 24340 form A (without locating pin), or ISO 4401-03-02-0-94 (with locating pin $\varnothing 4 \times 4$ mm deep)

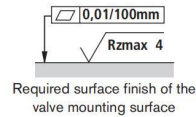

- Valve fixing screws (separate order)**
- 4 S.H.C.S. ISO 4762 - M5 - 10.9-fizh-240h-L
Friction co-efficient $\mu_{total} = 0.09$ to 0.14 ;
Tightening torque $M_A = 7.4$ Nm $\pm 10\%$,
or
 - 4 S.H.C.S. ISO 4762 - M5 - 10.9
Friction co-efficient $\mu_{total} = 0.12$ to 0.17 ,
Tightening torque $M_A = 8.1$ Nm $\pm 10\%$

Notes

Bosch Rexroth AG
Industrial Hydraulics
Zum Eisengießer 1
97816 Lohr am Main, Germany
Telefon +49 (0) 93 52 / 18-0
Telefax +49 (0) 93 52 / 18-23 58
documentation@boschrexroth.de
www.boschrexroth.de

© This document, as well as the data, specifications and other informations set forth in it, are the exclusive property of Bosch Rexroth AG. Without their consent it may not be reproduced or given to third parties.
The data specified above only serves to describe the product. No statements concerning a certain condition or suitability for a certain application can be derived from our information. The details stated do not release you from the responsibility for carrying out your own assessment and verification. It must be remembered that our products are subject to a natural process of wear and ageing.