

HSF

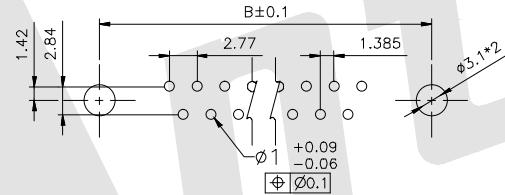
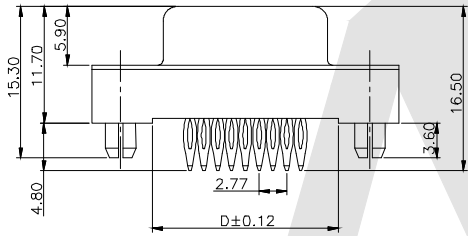
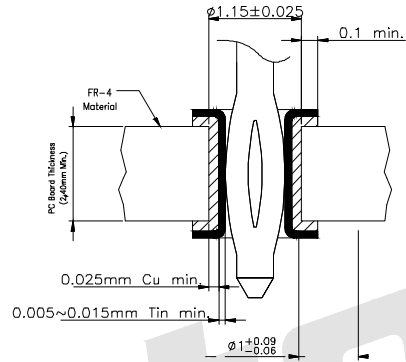
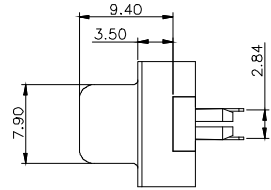
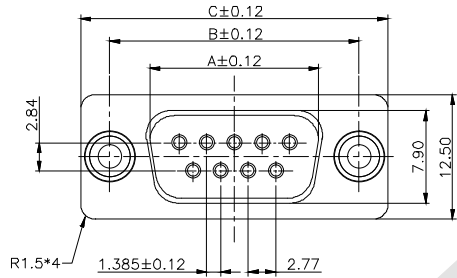

**Material:**

Housing: Temperature Thermoplastics, PBT+G.F UL 94V-0

Contact: Brass or Bronze

Shell: 0.35T Steel Nickel Plating All Area

**Electical Characteristics:**

Current Rating: 5A

Contact Resistance: 20 milliohms Max

Withstanding Voltage: 500V AC For 1 Minute

Insulation Resistance: 1000 Megohms Min

Operating Temperature: -55° C to +105° C

Ordering Code:

DG01 - F - X - A - 0 - B - S  
 ① ② ③ ④ ⑤ ⑥ ⑦

① press fit d-sub connector

② Contact Type:

F:Female

③ Contact NO.:

09=09pin 15=15pin

25=25pin 37=37pin

④ Mounting Option:

F: With boardlock post (PD=2.9mm ID=2.5mm)

⑤ Accessories:

0:Non Accessories

⑥ Color Code:

W:White L:Blue

B:Black G:Grey

⑦ Contact Plating

S: Selective Gold

S1:Selective 3u" Gold

S2:Selective 5u" Gold

S3:Selective 10u" Gold

S4:Selective 15u" Gold

S5:Selective 30u" Gold

G0: Gold flash

G1: 3u" Gold over

G2: 5u" Gold over

G3: 10u" Gold over

G4: 15u" Gold over

G5: 30u" Gold over

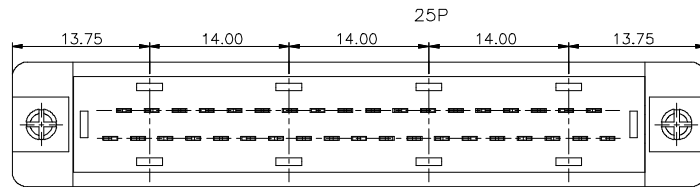
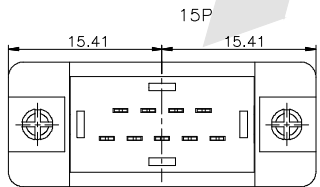
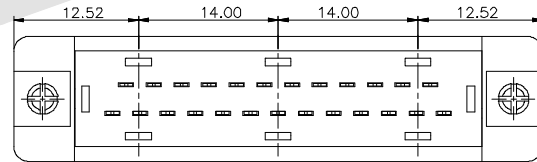
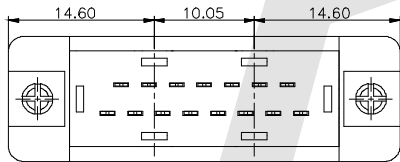

09P

37P

POSITION	A	B	C	D
09F	16.35	24.99	30.81	18.61
15F	24.70	33.32	39.25	27.15
25F	38.40	47.04	53.03	40.93
37F	54.80	63.50	69.50	57.40

Unless Otherwise specified tolerance

X. ±0.35 X.XX:±0.20

X.X:±0.25 X.XXX:±0.15

SCALE: As Shown UNIT: mm

DRAW: TMX DATE: 11/02/2021

CHECK: BobYang DATE: 11/02/2021



ANTENK ELECTRONICS CO., LTD

Http://www.antenk.com

E-mail:sales@antenk.com

TITLE: D-SUB PRESS FIT TYPE FEMALE CONNECTOR

DRAWING NO: DG01-FXXXXX

PRODUCT NO: DG01-FXXXXX

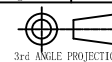

3rd ANGLE PROJECTION

REV DESCRIPTION

DATE

1

2

3

4

5

6

7

8