

HSF

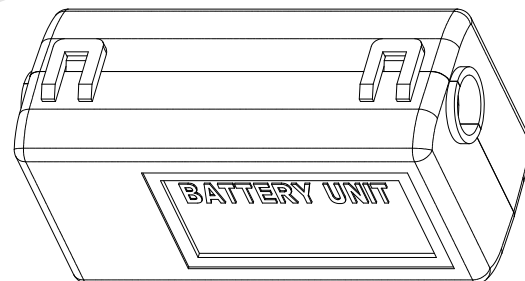
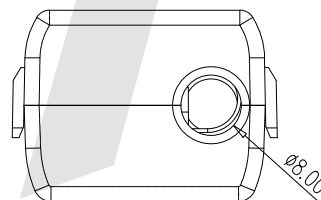
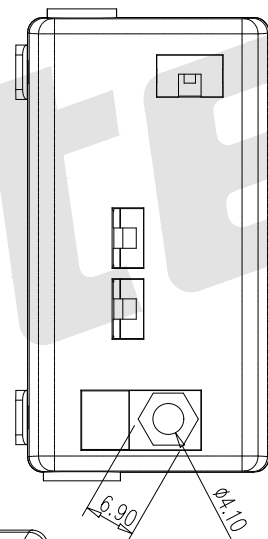
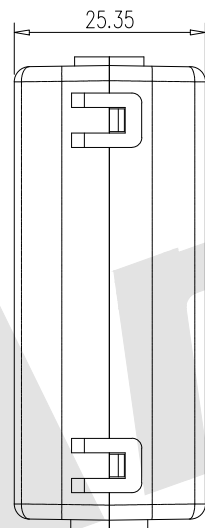
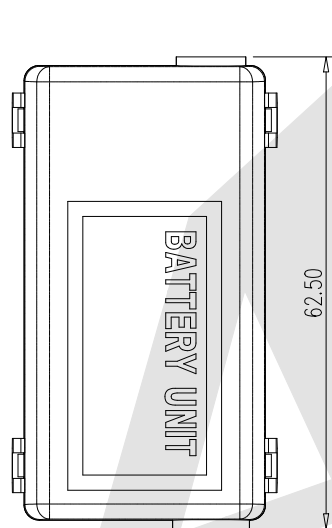
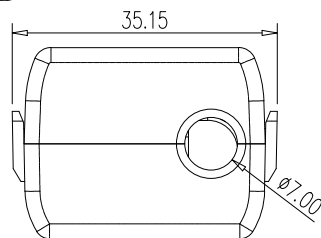

Notes:

1. Material

Shell: Pa66

Clip: PP

2. Mate With Screw And Nut M4

Ordering Code:

BBB - B - ER14335-01

① ② ③

① BBB: Battery Holders

② Packing Method

A: Tray

B: BAG

③ Product Number:

ER14335-01

Unless Otherwise specified tolerance  
X.±0.35 X.XX:±0.20  
X.X:±0.25 X.XXX:±0.15

SCALE: As Shown UNIT: mm  
DRAW ZLA DATE 09/11/2023  
CHECK BobYang DATE 09/11/2023  
VER./版本号

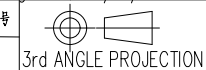

**Antenk** ANTEK ELECTRONICS CO.,LTD  
Http://www.antenk.com  
E-mail:sales@antenk.com

TITLE: Battery Holder For ER14335 Lithium Battery

DRAWING NO: BBB-B-ER14335-01

PRODUCT NO: BBB-B-ER14335-01

MK/标记

DESCRIPTION/修订内容

DATE/日期(M/D/Y)

HSF

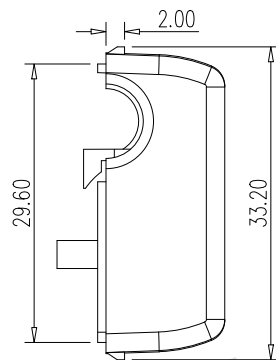
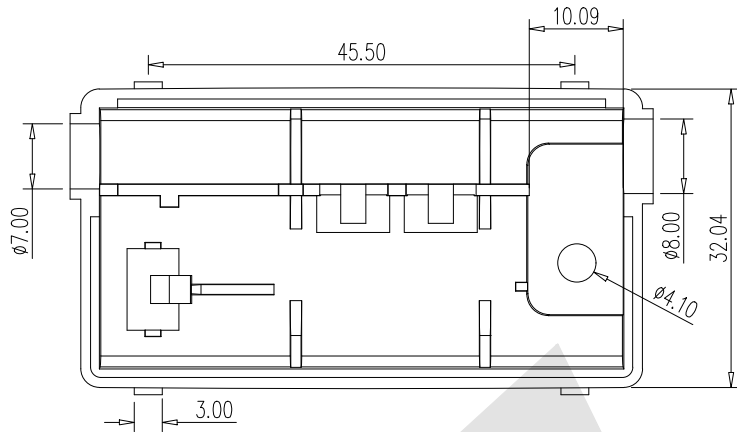

Notes:  
1. Material: Pa66

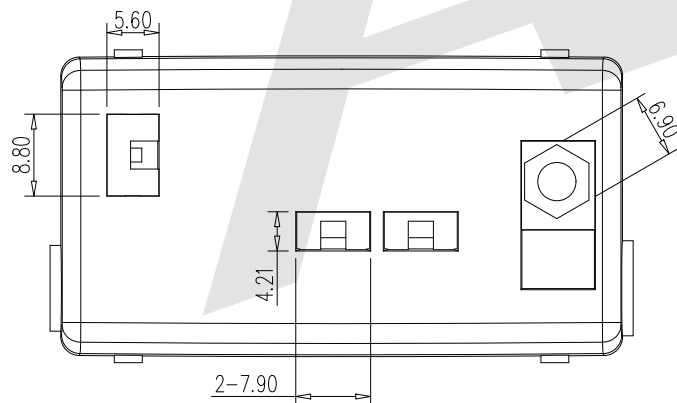
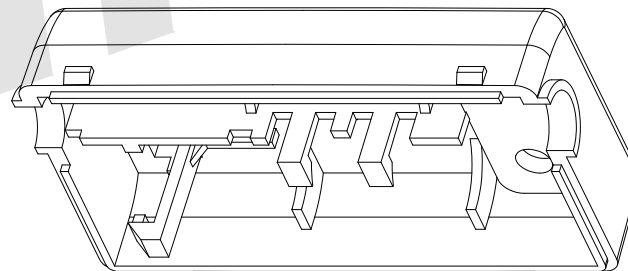
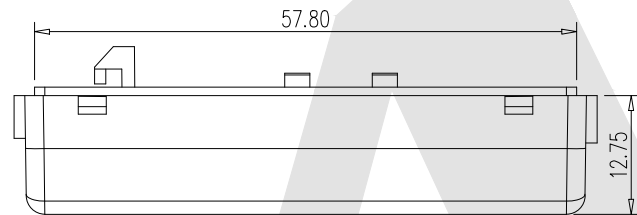

Unless Otherwise specified tolerance  
X.±0.35 X.XX:±0.20  
X.X:±0.25 X.XXX:±0.15

SCALE: As Shown UNIT: mm  
DRAW ZLA DATE 09/11/2023  
CHECK BobYang DATE 09/11/2023

VER./版本号  
3rd ANGLE PROJECTION

**Antenk** ANTEK ELECTRONICS CO.,LTD  
Http://www.antenk.com  
E-mail:sales@antenk.com

TITLE: Bottom Shell  
DRAWING NO:  
PRODUCT NO:

MK/标记	DESCRIPTION/修订内容	DATE/日期(M/D/Y)
-------	------------------	----------------

HSF



ROHS

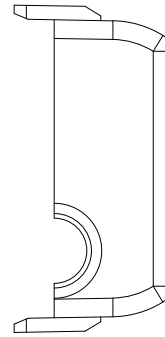
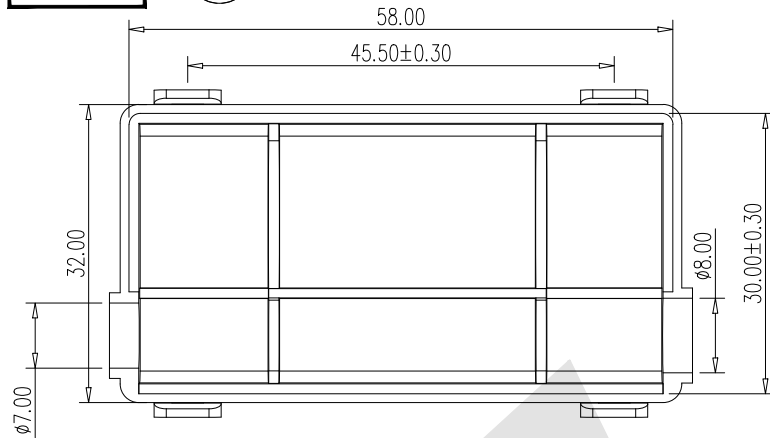

Notes:  
1. Material: Pa66

Antenk

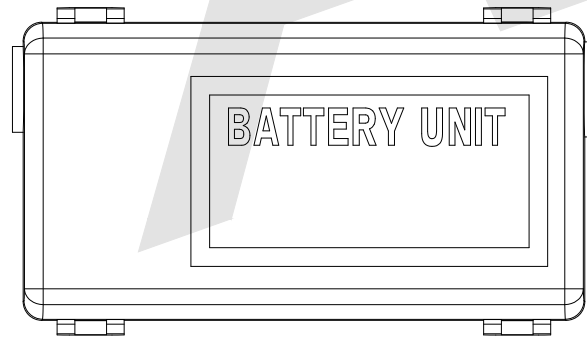
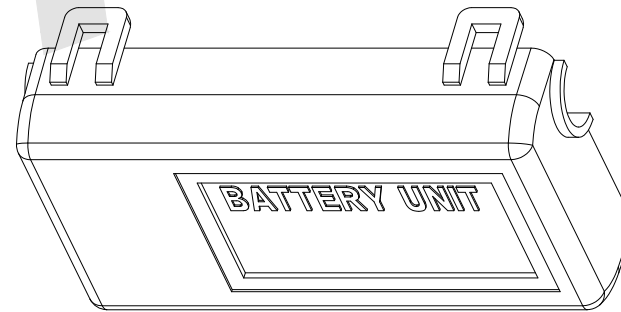

Unless Otherwise specified tolerance  
 X.±0.35 X.XX:±0.20  
 X.X:±0.25 X.XXX:±0.15

**Antenk** ANTEK ELECTRONICS CO.,LTD  
[Http://www.antenk.com](http://www.antenk.com)  
 E-mail:sales@antenk.com

SCALE: As Shown	UNIT: mm
DRAW ZLA	DATE 09/11/2023
CHECK BobYang	DATE 09/11/2023

TITLE:  
Top Shell

VER./版本号 3rd ANGLE PROJECTION

DRAWING NO:  
PRODUCT NO:

MK/标记	DESCRIPTION/修订内容	DATE/日期(M/D/Y)
-------	------------------	----------------

HSF

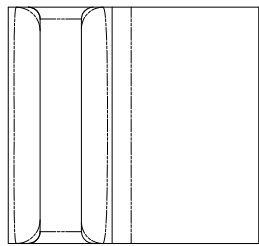
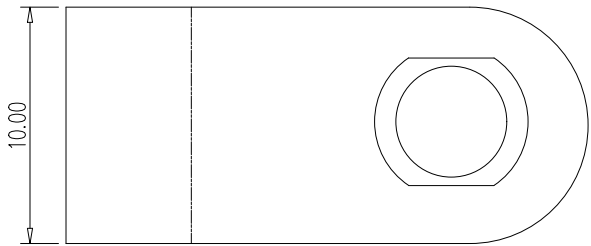

Notes:  
1. Material: PP

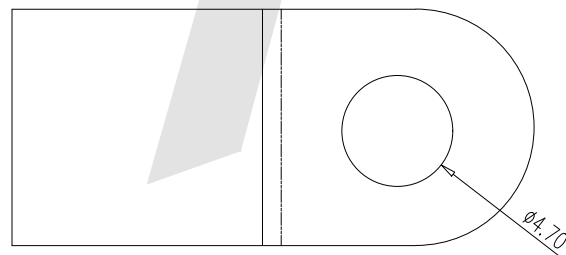
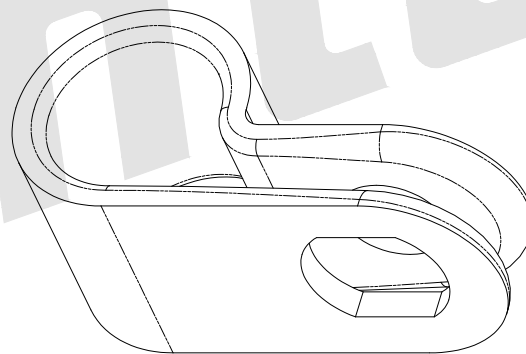
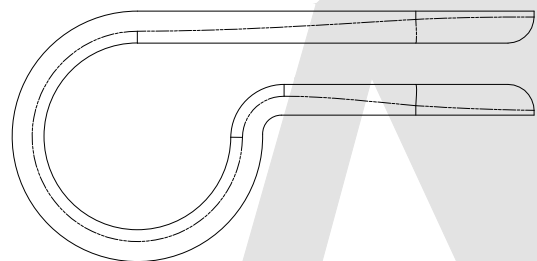

Unless Otherwise specified tolerance  
X.±0.35 X.XX:±0.20  
X.X:±0.25 X.XXX:±0.15

SCALE: As Shown UNIT: mm  
DRAW ZLA DATE 09/11/2023  
CHECK BobYang DATE 09/11/2023

VER./版本号  
3rd ANGLE PROJECTION

**Antenk** ANTENK ELECTRONICS CO.,LTD  
Http://www.antenk.com  
E-mail:sales@antenk.com

TITLE: Clip  
DRAWING NO:  
PRODUCT NO:

MK/标记	DESCRIPTION/修订内容	DATE/日期(M/D/Y)