

HSF

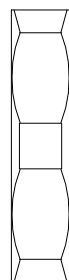

RoHS

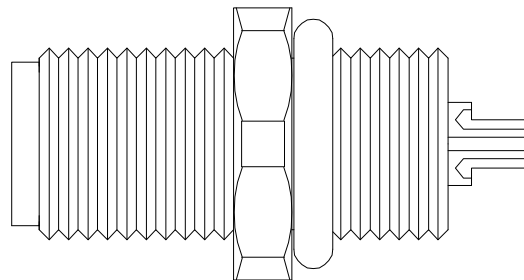

	2 Pin	3 Pin	4 Pin
Pin			

Ordering Code:

M5 - XP - M - 001  
 ①      ②      ③      ④

- ① Type of M series : M5
- ② NO. of PINS: 02~04
- ③ Gender option:  
M: Male
- ④ Series number: 001

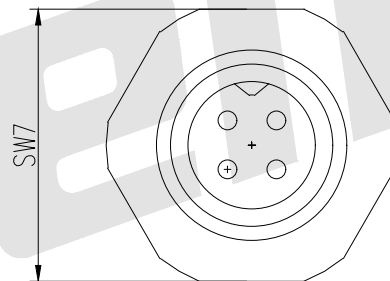
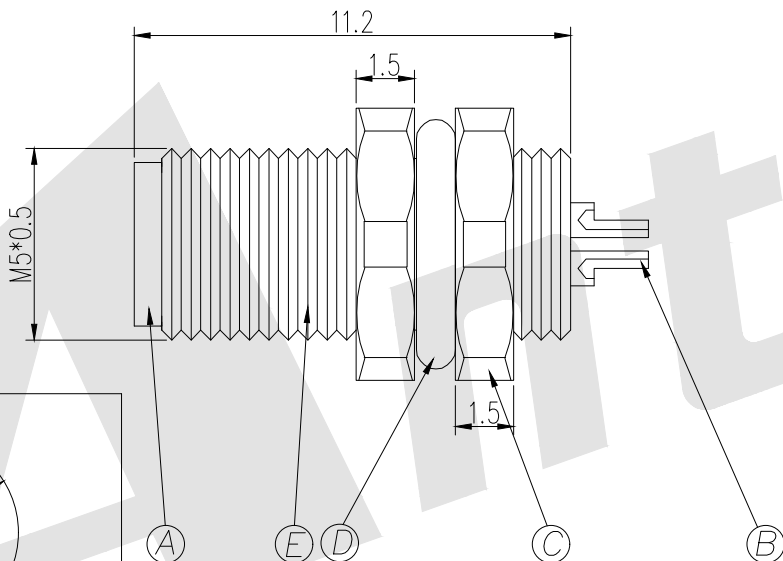
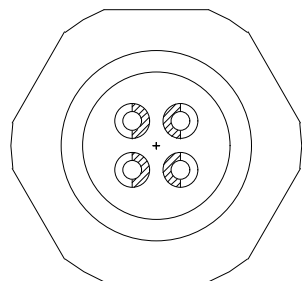

Recommended  
Panel  
Cut-out

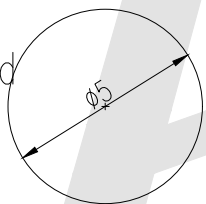

Item	PART NAME	QTY	MATERIAL /FINISH
E	Over Mold	1	NICKL PLATED BRASS
D	O RING	1	SILIGONE RED
C	NUT	1	NICKL PLATED BRASS
B	male PIN	/	GOLD PLATED BRASS
A	BODY	1	PA66+GF BLACK

Engagement force	≤30N	Rated volage	60v DC
engagement force	≥5N	Rated current	1A
mechanical lifespan	≥500	Insulation resistance	≥1000 MΩ
IP rating	IP67/IP68	Contact resistance	≤10mΩ
Flammability	UL94 v-0	Operation Temperature	-40 TO+105℃

Unless Otherwise specified tolerance  
 X.±0.35    X.XX: ±0.20  
 X.X: ±0.25    X.XXX: ±0.15

SCALE: As Shown	UNIT: mm
DRAW ZLA	DATE 24/05/2022
CHECK BobYang	DATE 24/05/2022

**Antenk**® ANTENK ELECTRONICS CO.,LTD  
 Http://www.antenk.com  
 E-mail:sales@antenk.com

TITLE: M5 2-4P Waterproof Plug Wire Side,  
 Lock Back Panel SW7

DRAWING NO: M5-XP-M-001

PRODUCT NO: M5-XP-M-001

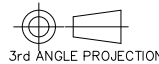

REV	DESCRIPTION	DATE