

HSF

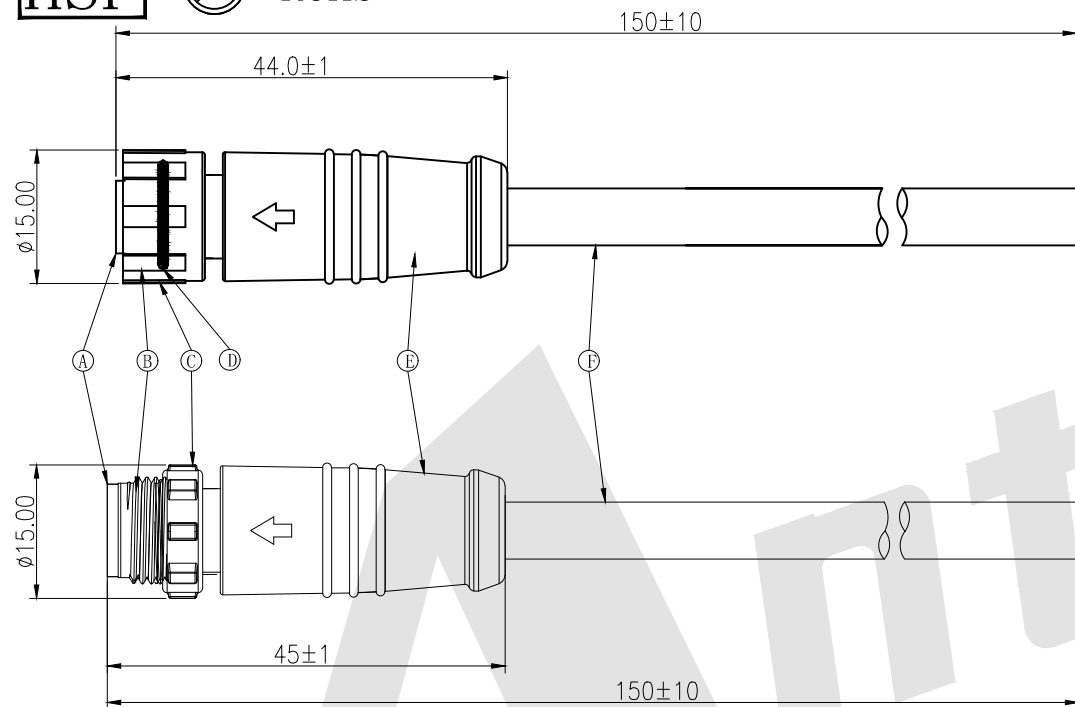

ROHS



NOTES:

1. WATERPROOF RATE:IP67
IP67:IMMERSED IN 1M WATER FOR 30 MINUTES
2. TEMPERATURE RANGE:-40° TO+80°
3. ELECTRICAL CHARACTERISTICS:
1-1 CURRENT RATING: 8AMPS+2AMPS.
1-2 CONTACT RESISTANCE : ≤10mΩ
1-3 INSULATION RESISTANCE:100 MOhm Min. at 500VDC.
1-4 BREAKDOWN VOLTAGE:500 V AC PER MINUTE.
4. LFE TEST:500 CYCLES MIN.
5. OTHER GENERAL SPEG TO REFER "CIRCUAR SERIES GENERAL SPEC".
6. TO CONFORM TO ROHS REQUIREMENT
7. GREEN PRODUCT IDENTIFIGATION LABEL ON PACKAGING:ROHs

Ordering Code:

M12P - XP - X - 004
① ② ③ ④

- ① Type of M series: M12P
- ② NO. of PINS:02~12
- ③ Gender option:
F:Female M:Male
- ④ Series number:004

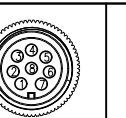
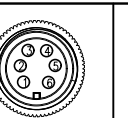
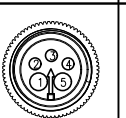
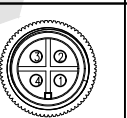
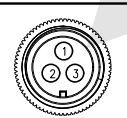
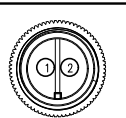
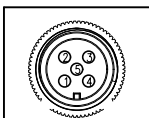

Pin Assignments 2 Pin	Pin Assignments 3 Pin	Pin Assignments 4 Pin	Pin Assignments 5 Pin	Pin Assignments 6 Pin	Pin Assignments 8 Pin	Pin Assignments 12 Pin
--------------------------	--------------------------	--------------------------	--------------------------	--------------------------	--------------------------	---------------------------

F	Cable	1	DEMAND
E	Over Mold	1	NYLON(UV) BLACK
D	O RING	1	SILIGONE RED
C	FEMALE SCREW NUT	1	NYLON+GF BLACK
B	male PIN	/	GOLD PLATED BRASS
	Female PIN	/	PHOSPHOR BRONZE GOLD PLATING OVER NICKEL PLATING
A	BODY	1	NYLON+GF BLACK
Item	PART NAME	QTY	MATERIAL /FINISH

Unless Otherwise specified tolerance

X. ±0.35 X.XX: ±0.20
X.X: ±0.25 X.XXX: ±0.15

SCALE: As Shown UNIT: mm

DRAW ZLA DATE 13/05/2022

CHECK BobYang DATE 13/05/2022

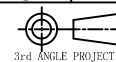

Antenk ANTENK ELECTRONICS CO., LTD
Http://www.antenk.com
E-mail:sales@antenk.com

TITLE: M12P Vertical Metal nuts
Waterproof Connector

DRAWING NO: M12P-XP-X-004

PRODUCT NO: M12P-XP-X-004

REV	DESCRIPTION	DATE
-----	-------------	------