

HSF



ROHS

Notes:

- Waterproof rate: IP67
IP67: Immersed in 1M water for 30 Minutes
- Electrical characteristics
Temperature range: -40° C to +100° C
2~5P rating: 60V AC/DC 5A ; 6~8P rating: 60V AC/DC 1.5A
Dielectric withstanding voltage:
2~5P: 500V AC for one minute ; 6~8P: 250V AC for one minute
3. For panel thickness Max of 3.5mm

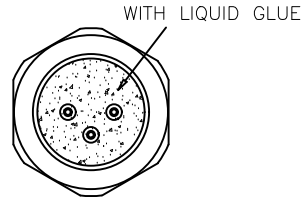
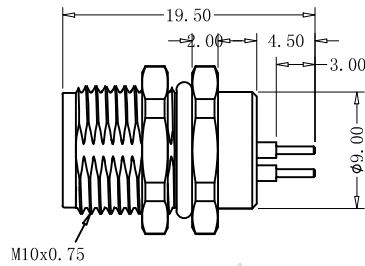
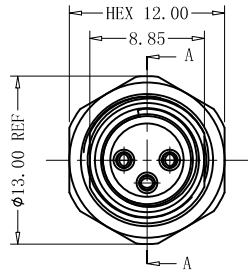

3D View

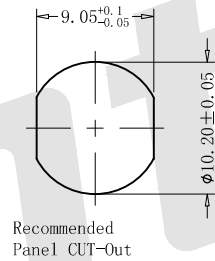
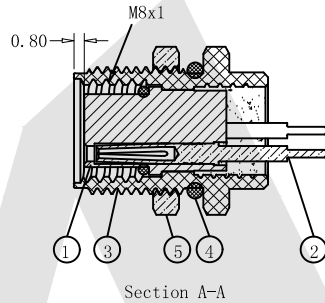

RECOMMENDED PCB LAYOUT

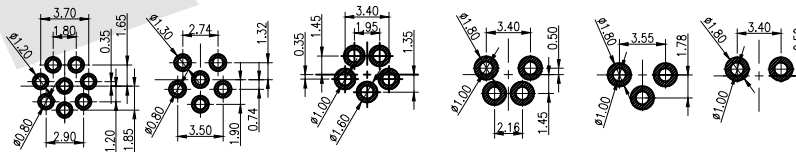

Order Code:

- M8 - XP - F - 142
 ① ② ③ ④
 ① Type of M series: M8
 ② NO. of PINS: 02~08
 ③ Gender option: Female
 ④ Series number: 142

M8-02P-F-142	
M8-03P-F-142	
M8-04P-F-142	
M8-05P-F-142	
M8-06P-F-142	
M8-08P-F-142	
P/N	PIN ASSIGNMENTS FRONT VIEW

5	Nut	Copper alloy	Nickel plating 60u	1
4	Waterproof ring	Silicone	Red	1
3	Shell	Copper alloy	Nickel plating 60u	1
2	Plug Pin	Copper alloy	Gold plating 3u	2~8
1	Plastic core	Nylon UL94 V-0	Black	1
NO.	ITEM	MATERIALS	SURFACE	QUANTITY

Unless Otherwise specified tolerance
 X. ±0.35 X.XX: ±0.20
 X.X: ±0.25 X.XXX: ±0.15

SCALE: As Shown UNIT: mm
 DRAW ZLA DATE 19/04/2022
 CHECK BobYang DATE 19/04/2022

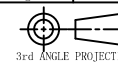

3rd ANGLE PROJECTION

Antenk ANTENK ELECTRONICS CO., LTD
[Http://www.antenk.com](http://www.antenk.com)
 E-mail: sales@antenk.com

TITLE:
 M8 2~8P Female Lock Front DIP 180°

DRAWING NO: M8-XP-F-142

PRODUCT NO: M8-XP-F-142

REV	DESCRIPTION	DATE