

HSF



ROHS

NOTE: MATERIAL: ASB UL-94V-0

A

B

C

D

A

B

C

D

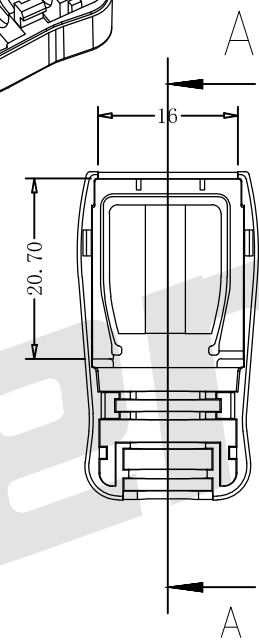
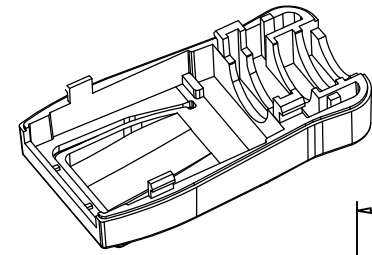
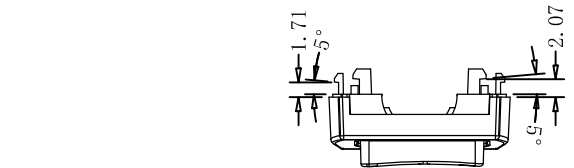

A-A

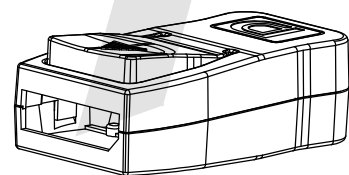
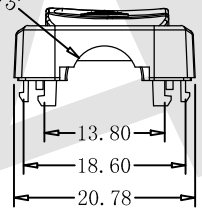
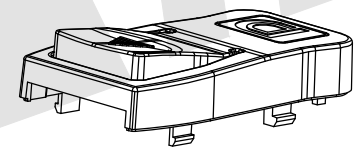
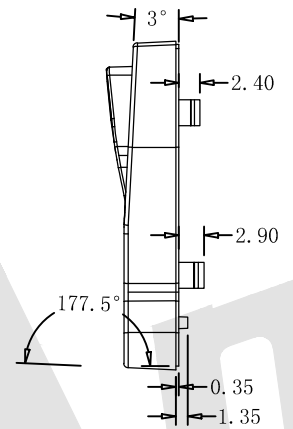
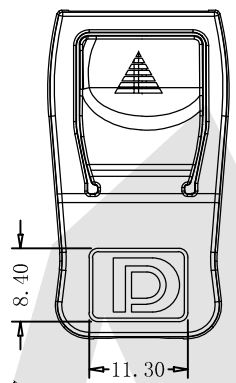
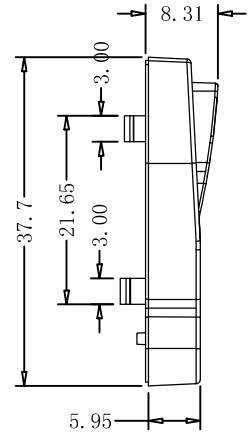
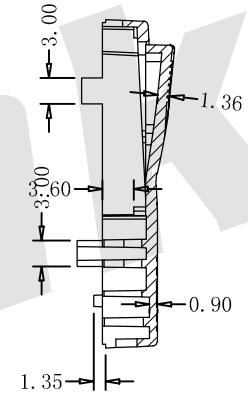

Ordering Code:

DP - S - 01
① ② ③

- ① Series No:
 - ② Shell:S
 - ③ Series Num
- 01

Unless Otherwise specified tolerance
 X. ±0.35 X.XX: ±0.20
 X.X: ±0.25 X.XXX: ±0.15

Antenk ANTENK ELECTRONICS CO., LTD
[Http://www.antenk.com](http://www.antenk.com)
 E-mail:sales@antenk.com

SCALE: As Shown	UNIT: mm
DRAW ZLA	DATE 26/03/2022
CHECK BobYang	DATE 26/03/2022

TITLE:
Display Port Shell Top Cover

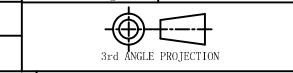

DRAWING NO: DP-S-01
 PRODUCT NO: DP-S-01

REV	DESCRIPTION	DATE
1		
2		
3		
4		
5		

HSF



ROHS

NOTE:
MATERIAL: ASB UL-94V-0

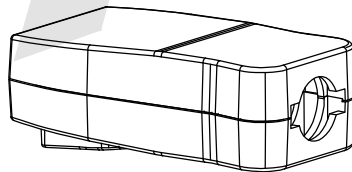
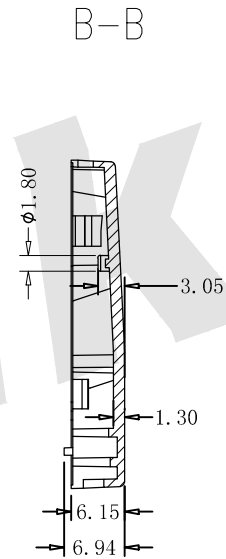
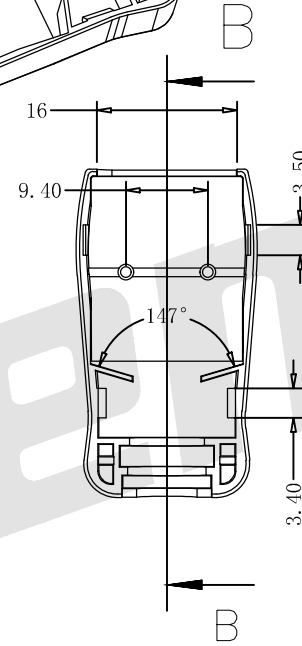
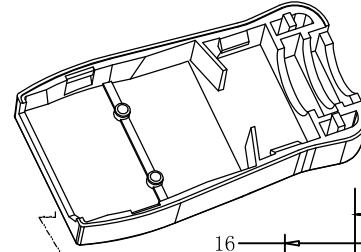
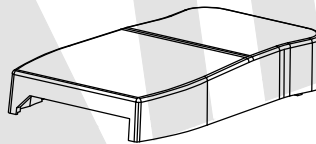
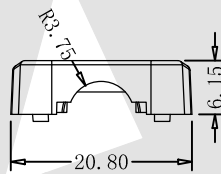
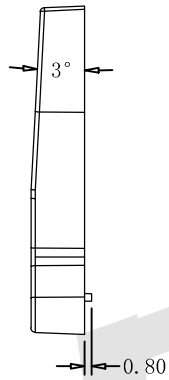
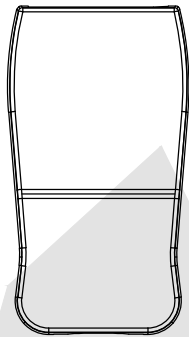
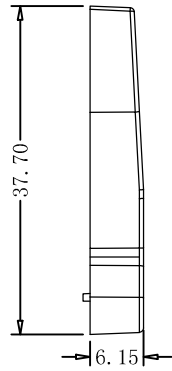
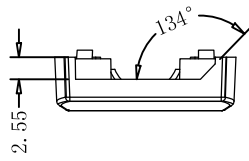

Ordering Code:

DP - S - 01
① ② ③

① Series No:

② Shell:S

③ Series Num
01

Unless Otherwise specified tolerance

X. ±0.35 X.XX: ±0.20
X.X: ±0.25 X.XXX: ±0.15

SCALE: As Shown UNIT: mm

DRAW ZLA DATE 26/03/2022

CHECK BobYang DATE 26/03/2022

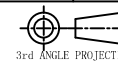

Antenk ANTENK ELECTRONICS CO., LTD
Http://www.antenk.com
E-mail:sales@antenk.com

TITLE:
Display Port Shell Bottom Cover

DRAWING NO: DP-S-01

PRODUCT NO: DP-S-01

REV	DESCRIPTION	DATE
1		