

HSF

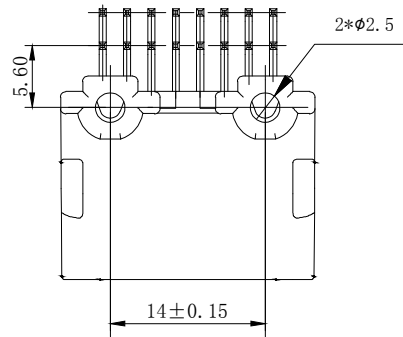

Section A-A

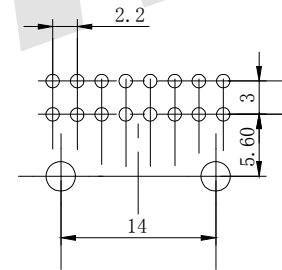
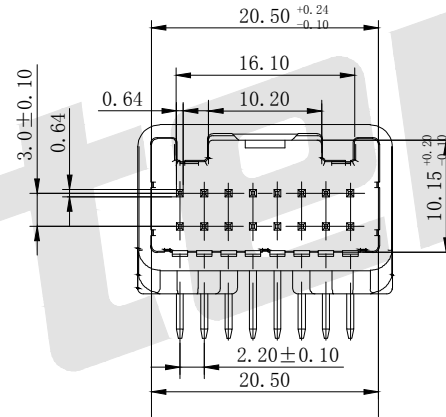
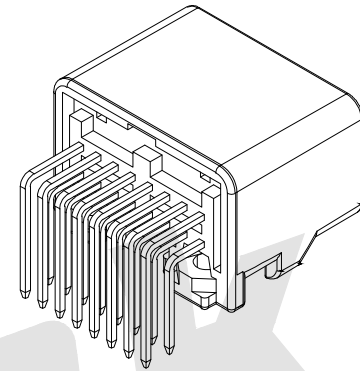
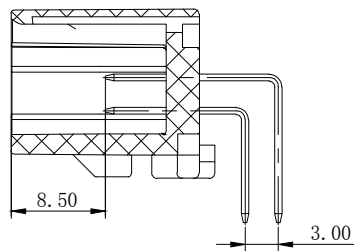

PCB LAYOUT

Ordering Code:

AUTO - 16 SN - A A - X
 CONTACT NO. 16: 16PIN
 CONTACT PLATING
 G0: Gold Flash
 G1: 3u" Gold
 G2: 5u" Gold
 G3: 10u" Gold
 G4: 15u" Gold
 G5: 30u" Gold
 SN: Tin
 COLOR A: WHITE
 MATERIAL A: PBT
 PACK: A: TRAY, B: BOX, C: TUBE

NOTE:

- 1. MATERIAL:
- 1.1 HOUSING: PBT+GF15 (WHITE)
- 1.2 CONTACT: COPPER TIN PLATED

The unmarked tolerance shall be in accordance with GB / T 1804-92 grade M

Size Range	0-5	5-20	20-45	45-70	70-100	100-250	≥250	Angle
Undeclared Tolerance	±0.15	±0.2	±0.3	±0.4	±0.5	±0.7	±0.15	±2°

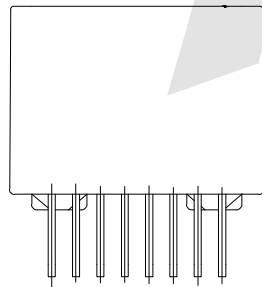
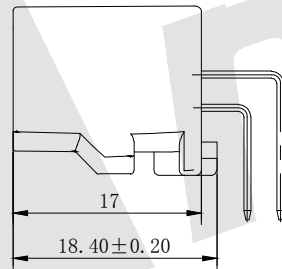
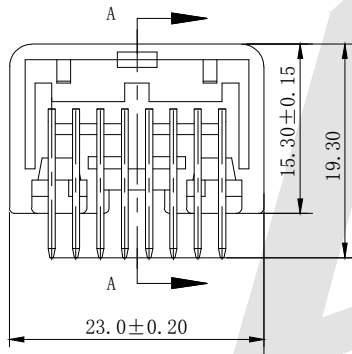

Unless Otherwise specified tolerance
 X. ±0.35 X.XX: ±0.20
 X.X: ±0.25 X.XXX: ±0.15

SCALE: As Shown UNIT: mm
 DRAW Wu Feng Rong DATE 07/13/2021
 CHECK BobYang DATE 07/13/2021



Antenk ANTENK ELECTRONICS CO., LTD
 Http://www.antenk.com
 E-mail:sales@antenk.com

TITLE:
 P2.2*3 16P Automotive Right Angle Male Connector

DRAWING NO: AUTO-16SN-AA-X

PRODUCT NO: AUTO-16SN-AA-X

REV	DESCRIPTION	DATE