

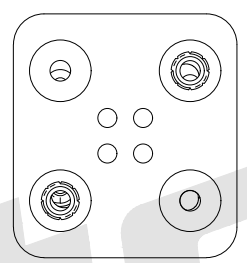

NOTES:
 1、HOLDER MATERIAL:POLYPROPYLENE.
 2、SPRING MATERIAL:MUSIC WIRE, 0.7DIA
 FINISH:NICKEL PLATED
 3、SNAP-ON TERMINAL MATERIAL: BRASS,NICKEL PLATE

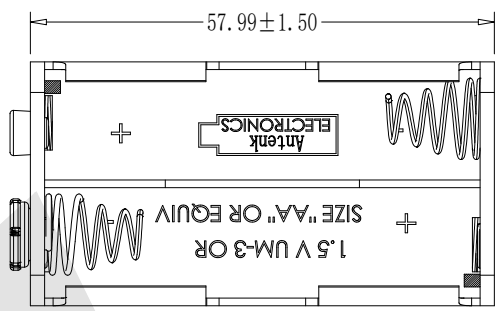
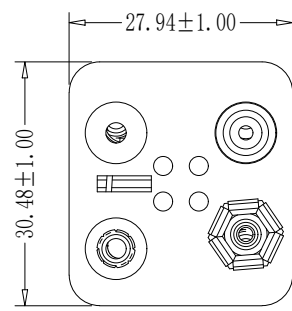

Ordering Code:
 BBA - 5 - 4 - B - S - 476
 ① ② ③ ④ ⑤ ⑥

- ① BBA:Battery Holders
- ② BATTERY TYPE
5: AAA SIZE
- ③ BATTERY NUMBERS
4: 4 pieces
- ④ Packing
A:TRAY B:BAG
- ⑤ S:With Snap
- ⑥ Series Number
476

POLARITY RIB (4) PLS
ON (+) SIDE

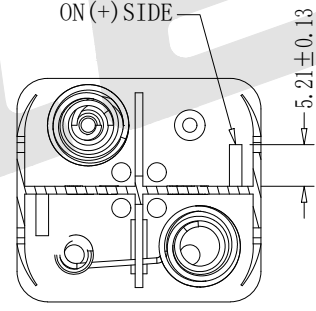

SECTION A-A

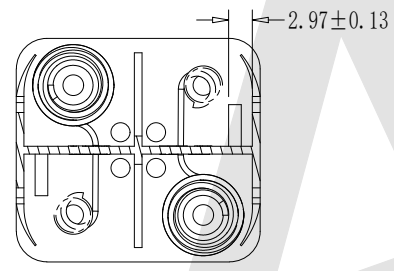

SECTION B-B

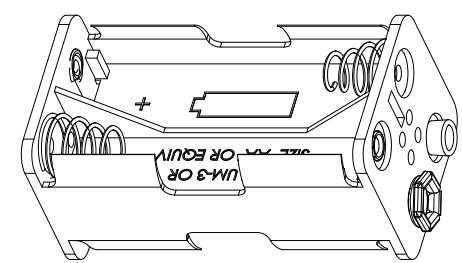
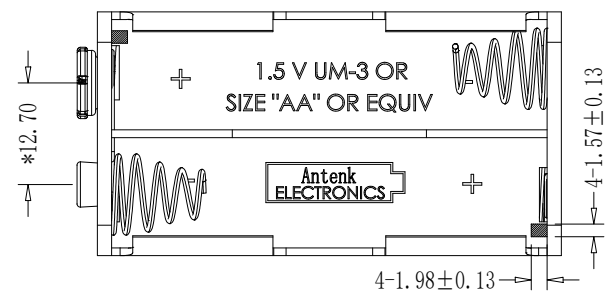
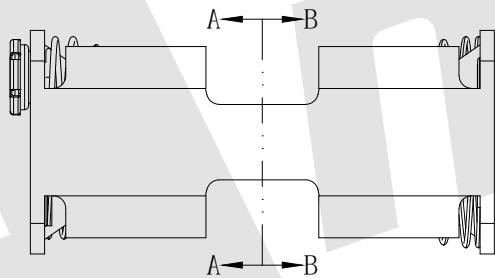

Unless Otherwise specified tolerance
 X. ±0.35 X.XX: ±0.20
 X.X: ±0.25 X.XXX: ±0.15

SCALE: As Shown UNIT: mm
 DRAW GONG FENG DATE 23/03/2022
 CHECK BobYang DATE 23/03/2022

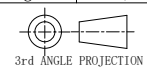

Antenk® ANTENK ELECTRONICS CO.,LTD
[Http://www.antenk.com](http://www.antenk.com)
 E-mail:sales@antenk.com

TITLE:
4 PIECES AA Battery Holders SNAP TYPE

DRAWING NO: BBA-5-4-B-S-476

PRODUCT NO: BBA-5-4-B-S-476

REV	DESCRIPTION	DATE
1		
2		
3		
4		
5		