

HSF

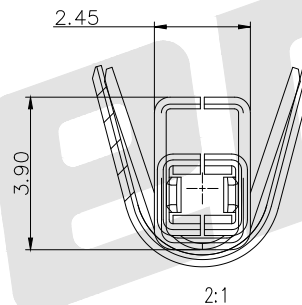

Notes:

1. Material: C181400, $T=0.30 \pm 0.01\text{mm}$
2. Appearance: the surface of the product is not allowed to be crushed, scratched, deformed, dirty, etc.
3. Plating: bright tin plated 50- 80u', over nickel plated 30~50u' all areal

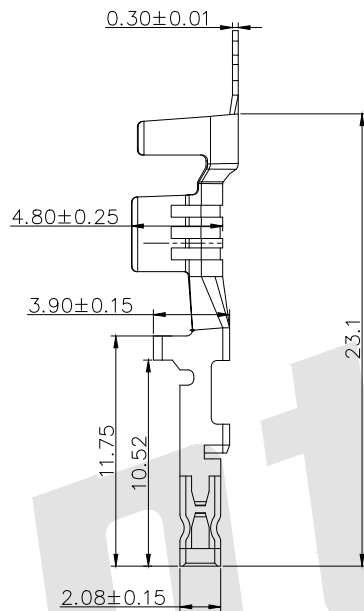
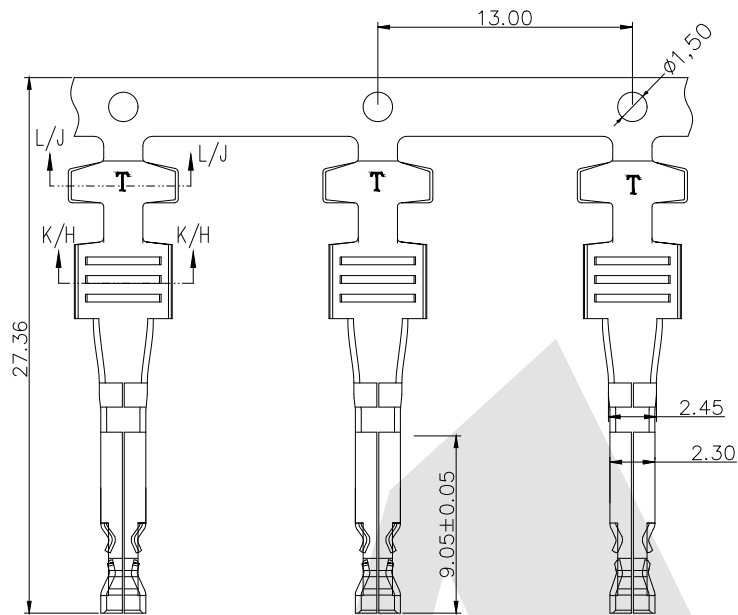
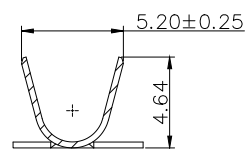

SECTION L-L

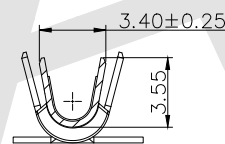

SECTION K-K
14-16awg

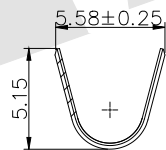

SECTION J-J

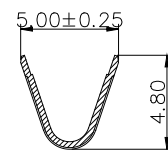

SECTION H-H

12awg

Ordering Information

Part No.	Wire range
AT5701F-B-1	#14-#16
AT5701F-B-2	#12

Unless Otherwise specified tolerance
 $X \pm 0.35$ $X.XX \pm 0.20$
 $X.X \pm 0.25$ $X.XXX \pm 0.15$

SCALE: As Shown UNIT: mm
 DRAW ZLA DATE 09/01/2022
 CHECK BobYang DATE 09/01/2022

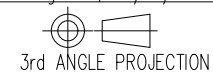

Antenk® ANTENK ELECTRONICS CO.,LTD
 Http://www.antenk.com
 E-mail:sales@antenk.com

TITLE: 5.70mm pitch Crimp Terminal Connector series

DRAWING NO: AT5701F-B-X

PRODUCT NO: AT5701F-B-X

REV	DESCRIPTION	DATE
1		
2		
3		
4		
5		