

BT137 Series 8A Triacs

DESCRIPTION:

With low holding and latching current, BT137 Series triacs are especially recommended for use on middle and small resistance type power load.

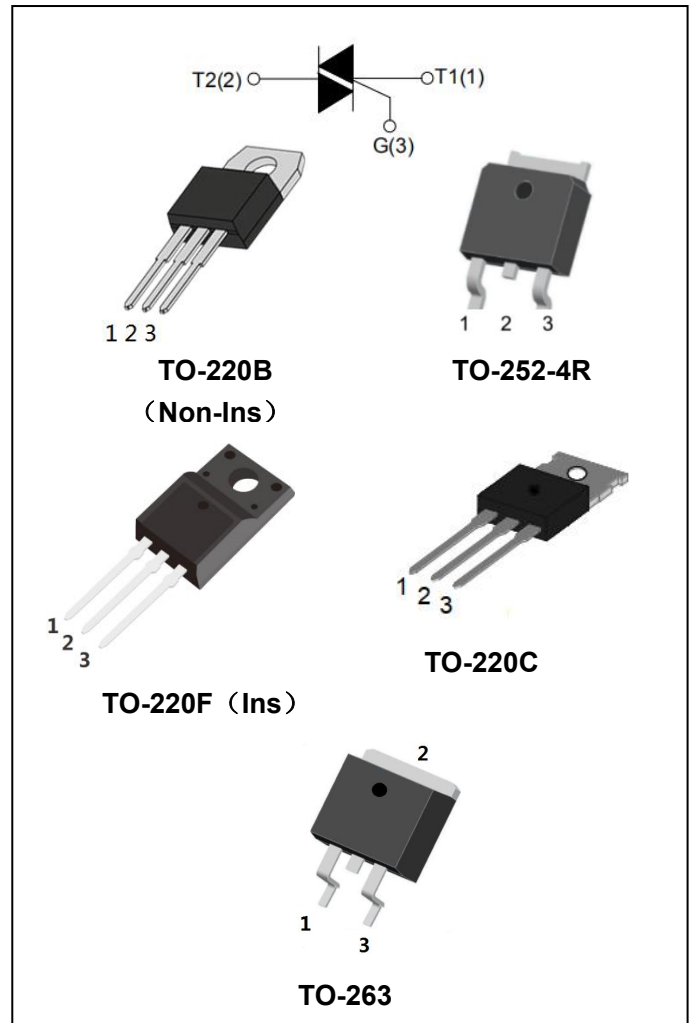

MAIN FEATURES:

symbol	value	unit
$I_{T(RMS)}$	8	A
V_{DRM}/V_{RRM}	600/800	V
V_{TM}	≤ 1.6	V

ABSOLUTE MAXIMUM RATINGS:

Parameter	Symbol	Value	Unit
Storage junction temperature range	T_{stg}	-40~150	°C
Operating junction temperature range	T_j	-40~125	°C
Repetitive peak off-state voltage ($T_j=25^\circ\text{C}$)	V_{DRM}	600/800	V
Repetitive peak reverse voltage ($T_j=25^\circ\text{C}$)	V_{RRM}	600/800	V
RMS on-state current	$I_{T(RMS)}$	8	A
Non repetitive surge peak on-state current (full cycle, F=50Hz)	I_{TSM}	65	A
I^2t value for fusing ($t_p=10\text{ms}$)	I^2t	21	A^2s

BT137 Series 8A Triacs

Critical rate of rise of on-state current ($I_G=2 \times I_{GT}$)	dI/dt	I - II - III	50	A/ μ s
		IV	10	
Peak gate current		I_{GM}	2	A
Average gate power dissipation		$P_{G(AV)}$	0.5	W
Peak gate power		P_{GM}	5	W

ELECTRICAL CHARACTERISTICS ($T_j=25^\circ\text{C}$ unless otherwise specified)

Parameter	Test Condition	Quadrant		Value				Unit
				D	E	F	G	
I_{GT}	$V_D=12\text{V}, R_L=33\Omega$	I - II - III	MAX	5	10	25	50	mA
		IV		10	25	70	100	
V_{GT}		I - II - III - IV		1.3				V
V_{GD}	$V_D=V_{DRM}$	I - II - III - IV	MIN	0.2				V
I_H	$I_T=100\text{mA}$		MAX	10	20	40	60	mA
I_L	$I_G=1.2I_{GT}$	I - III - IV	MAX	10	30	50	70	mA
		II		20	40	70	100	
dV/dt	$V_D=0.66 \times V_{DRM}$ $T_j=125^\circ\text{C}$ Gate open		MIN	20	50	100	200	V/ μ s

STATIC CHARACTERISTICS

Symbol	Test Condition			Value	Unit
V_{TM}	$I_{TM}=10\text{A}$ $t_p=380\mu\text{s}$	$T_j=25^\circ\text{C}$	MAX	1.6	V
I_{DRM} I_{RRM}	$V_{DRM}=V_{RRM}$	$T_j=25^\circ\text{C}$	MAX	5	μA
		$T_j=125^\circ\text{C}$		0.5	mA

BT137 Series 8A Triacs

THERMAL RESISTANCES

Symbol	Test Condition	Value	Unit
$R_{th(j-c)}$	TO-252-4R	2.0	°C/W
	TO-220B(Non-Ins)/ TO-220C	1.8	
	TO-220F	2.8	
	TO-263	3.0	

ORDERING INFORMATION

<p>BT 137-600 D</p> <p>Triacs</p> <p style="text-align: center;">$I_{T(RMS)}:8A$</p>	<p>V_{DRM}, V_{RRM}:</p> <p>600: 600V</p> <p>800: 800V</p>	<p>D: $I_{GT1-3} \leq 5mA, I_{GT4} \leq 10mA$</p> <p>E: $I_{GT1-3} \leq 10mA, I_{GT4} \leq 25mA$</p> <p>F: $I_{GT1-3} \leq 25mA, I_{GT4} \leq 70mA$</p> <p>G: $I_{GT1-3} \leq 50mA, I_{GT4} \leq 100mA$</p>
--	---	---

PACKAGE MECHANICAL DATA

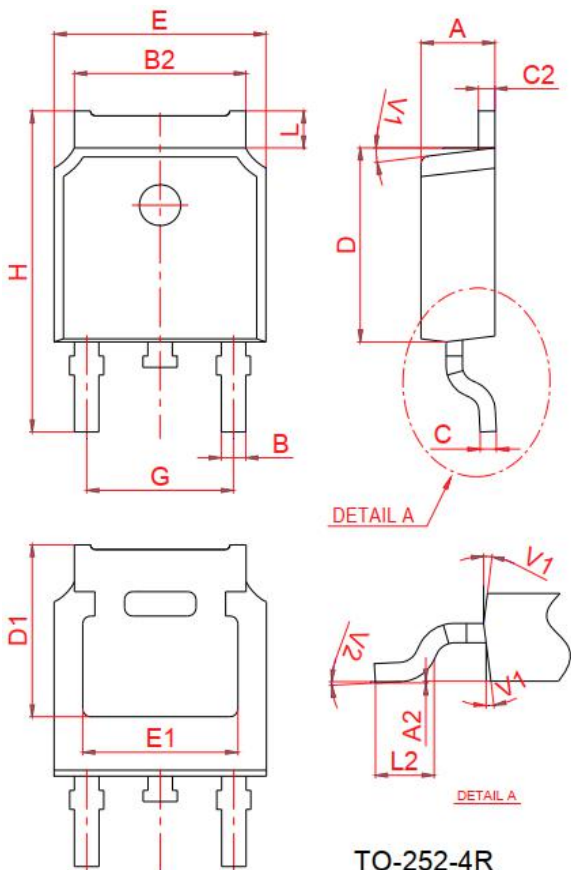

Ref.	Dimensions					
	Millimeters			Inches		
	Min.	Typ.	Max.	Min.	Typ.	Max.
A	2.2		2.4	0.087		0.094
A2	0		0.1	0		0.004
B	0.66		0.86	0.026		0.034
B2	5.1		5.46	0.201		0.215
C	0.46		0.58	0.018		0.023
C2	0.44		0.58	0.017		0.023
D	5.9		6.3	0.232		0.248
D1	5.30REF			0.211REF		
E	6.4		6.8	0.252		0.268
E1	4.63			0.182		
G	4.372		4.772	0.172		0.188
H	9.8		10.4	0.386		0.409
L	1.09		1.21	0.043		0.048
L2	1.35		1.65	0.053		0.065
V1		7°			7°	
V2	0°		6°	0°		6°

BT137 Series 8A Triacs

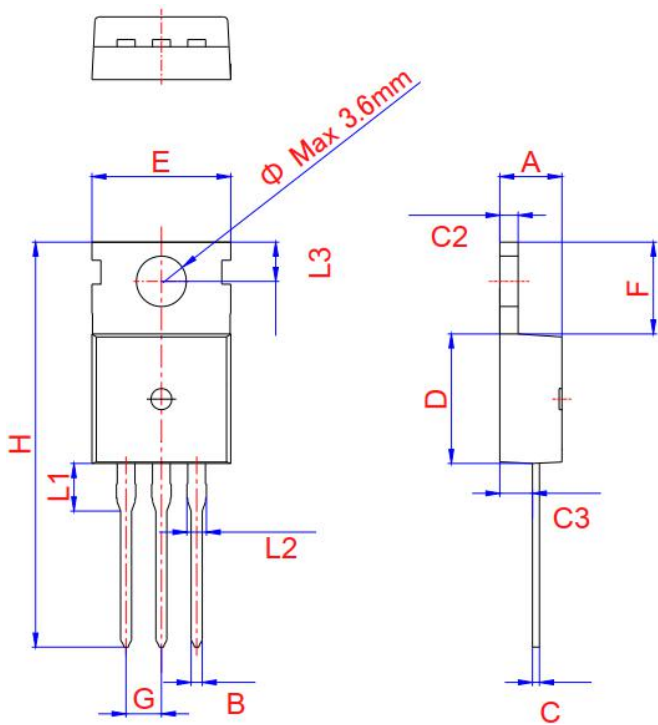

TO-220C

Ref.	Dimensions					
	Millimeters			Inches		
	Min.	Typ.	Max.	Min.	Typ.	Max.
A	4.3		4.5	0.169		0.177
B	0.7		0.9	0.028		0.035
C	0.45		0.6	0.018		0.024
C2	1.23	1.30	1.32	0.048	0.051	0.052
C3	2.2		2.6	0.087		0.102
D	8.9		9.9	0.35		0.39
E	9.9	10.1	10.3	0.39	0.398	0.406
F	6.3		6.9	0.248		0.272
G		2.54			0.1	
H	28		29.8	1.102		1.173
L1		3.39			0.133	
L2	1.14		1.7	0.045		0.067
L3	2.65		2.95	0.104		0.116
Φ		3.6			0.142	

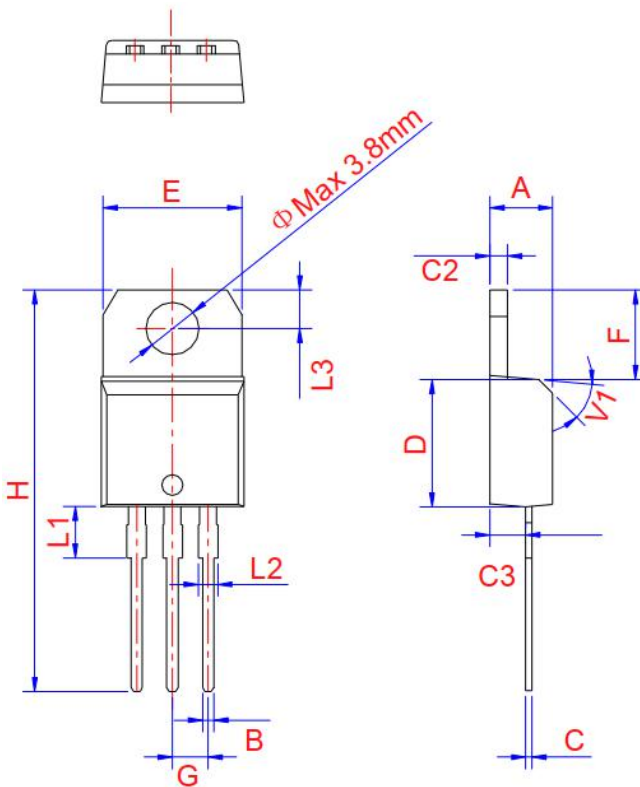

TO-220B Non-Ins

Ref.	Dimensions					
	Millimeters			Inches		
	Min.	Typ.	Max.	Min.	Typ.	Max.
A	4.4	4.47	4.6	0.173	0.176	0.181
B	0.61		0.88	0.024		0.035
C	0.46	0.50	0.7	0.018	0.02	0.028
C2	1.21	1.27	1.32	0.048	0.050	0.052
C3	2.4		2.72	0.094		0.107
D	8.6		9.7	0.339		0.382
E	9.8		10.4	0.386		0.409
F	6.55		6.95	0.258		0.274
G		2.54			0.1	
H	28		29.8	1.102		1.173
L1		3.75			0.148	
L2	1.14		1.7	0.045		0.067
L3	2.65		2.95	0.104		0.116
V1		45°			45°	

BT137 Series 8A Triacs

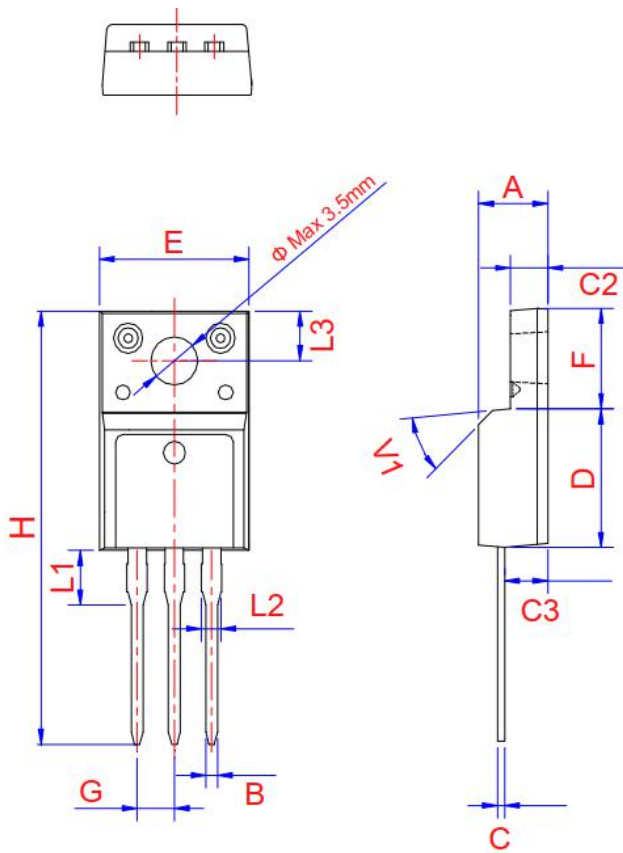

TO-220F Ins

Ref.	Dimensions					
	Millimeters			Inches		
	Min.	Typ.	Max.	Min.	Typ.	Max.
A	4.5		4.9	0.177		0.193
B	0.74	0.8	0.83	0.029	0.031	0.033
C	0.47		0.65	0.019		0.026
C2	2.45		2.75	0.096		0.108
C3	2.6		3	0.102		0.118
D	8.8		9.3	0.346		0.366
E	9.8		10.4	0.386		0.41
F	6.4		6.8	0.252		0.268
G		2.54			0.1	
H	28		29.8	1.102		1.173
L1		3.63			0.148	
L2	1.14		1.7	0.045		0.067
L3	2.65	3.3	0		0.13	0.116
V1		45°			45°	

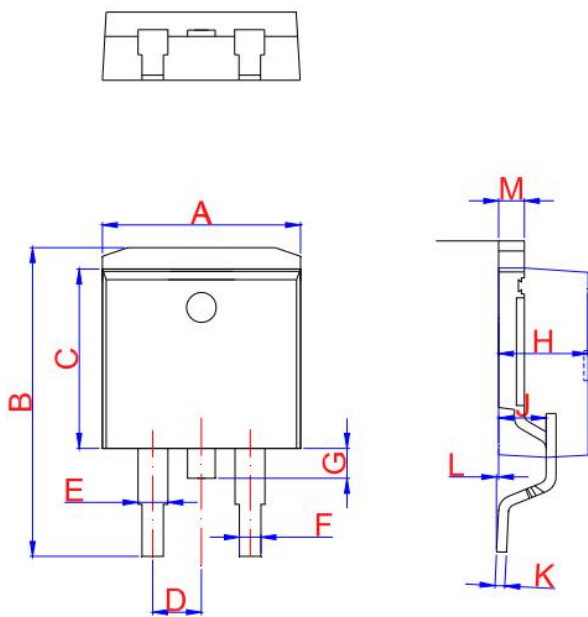

TO-263

Ref.	Dimensions					
	Millimeters			Inches		
	Min.	Typ.	Max.	Min.	Typ.	Max.
A	9.9		10.3	0.390		0.406
B	14.7		15.8	0.579		0.622
C	8.5		8.9	0.370		0.378
D		2.54			0.100	
E	1.20		1.40	0.047		0.055
F	0.75		0.85	0.029		0.033
G			1.75			0.069
H	4.40	4.60	4.80	0.173	0.181	0.189
J	2.40	2.60	2.80	0.094	0.102	0.110
L	0	0.1	0.25	0	0.004	0.010
M	1.17	1.27	1.37	0.046	0.05	0.054

BT137 Series 8A Triacs

FIG.1: Maximum power dissipation versus RMS on-state current

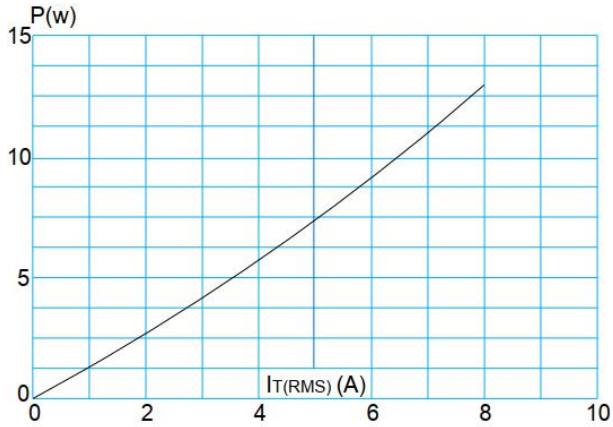

FIG.2: RMS on-state current versus case temperature

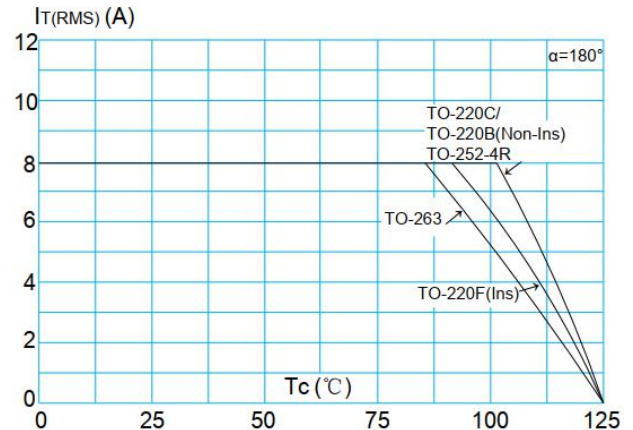

FIG.3: Surge peak on-state current versus number of cycles

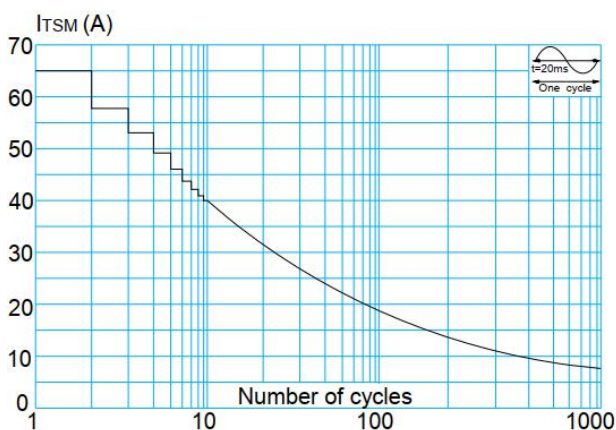

FIG.4: On-state characteristics (maximum values)

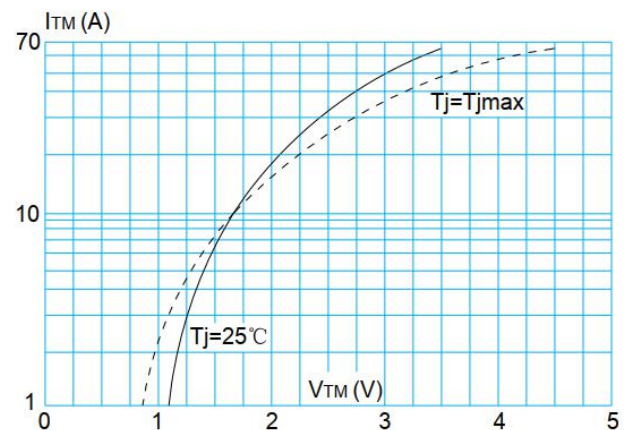

FIG.5: Non-repetitive surge peak on-state current for a sinusoidal pulse with width $t_p < 20\text{ms}$, and corresponding value of I^2t ($I - II - III: dI/dt < 50\text{A}/\mu\text{s}; IV: dI/dt < 10\text{A}/\mu\text{s}$)

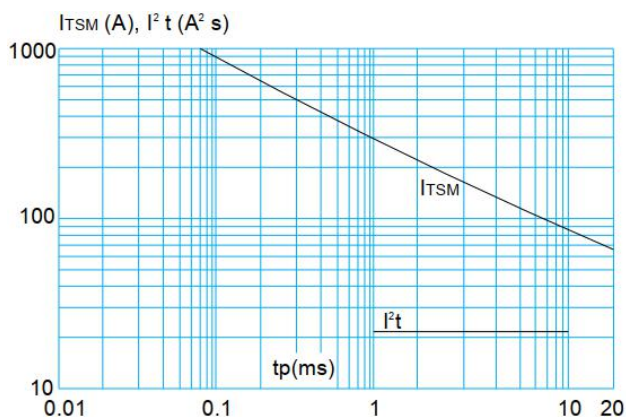
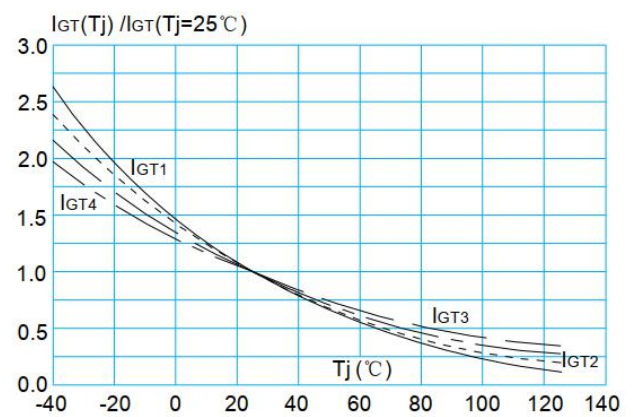

FIG.6: Relative variations of gate trigger current versus junction temperature



BT137 Series 8A Triacs

FIG.7: Relative variations of holding current versus junction temperature

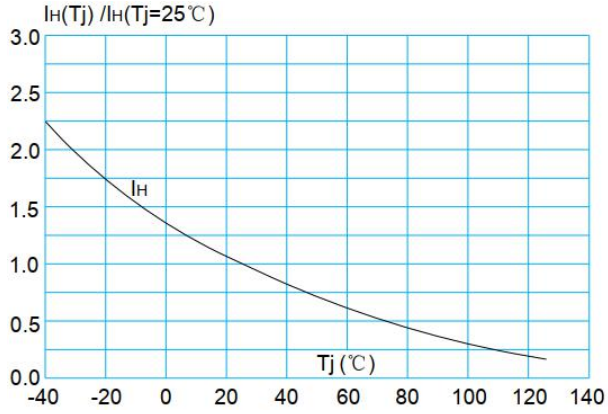

FIG.8: Relative variations of latching current versus junction temperature

