

150B120F23

IGBT Power Module

$V_{CE}=1200V$ $I_C=150A$

Applications

- Inverter for motor drive
- AC and DC servo drive amplifier
- UPS (Uninterruptible Power Supplies)
- Soft switching welding machine



Features

- Low $V_{ce(sat)}$ with Trench Field-stop technology
- $V_{ce(sat)}$ with positive temperature coefficient
- Including fast & soft recovery anti-parallel FWD
- High short circuit capability(10us)
- Low inductance module structure
- Maximum junction temperature 175°C

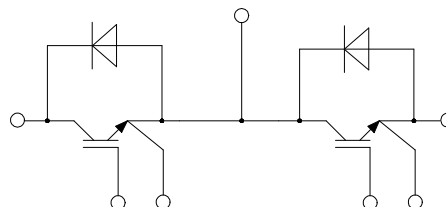

Equivalent Circuit Schematic

● Absolute Maximum Ratings

Parameter	Symbol	Conditions	Value	Unit
Collector-Emitter Voltage	V_{CES}	$V_{GE}=0V, I_C=1mA, T_{vj}=25^{\circ}C$	1200	V
Continuous Collector Current	I_C	$T_c=100^{\circ}C$	150	A
Peak Collector Current	I_{CRM}	$t_p=1ms$	300	A
Gate-Emitter Voltage	V_{GES}	$T_{vj}=25^{\circ}C$	± 20	V
Total Power Dissipation (IGBT-inverter)	P_{tot}	$T_c=25^{\circ}C$ $T_{vjmax}=175^{\circ}C$	968	W

● IGBT Characteristics

Parameter	Symbol	Conditions	Value			Unit
			Min.	Typ.	Max.	
Gate-Emitter Threshold Voltage	$V_{GE(th)}$	$V_{GE}=V_{CE}, I_C=4mA, T_{vj}=25^{\circ}C$	5.2	6.0	6.8	V
Collector-Emitter Cut-off Current	I_{CES}	$V_{CE}=1200V, V_{GE}=0V, T_{vj}=25^{\circ}C$			1.0	mA
		$V_{CE}=1200V, V_{GE}=0V, T_{vj}=125^{\circ}C$			5.0	mA
Collector-Emitter Saturation Voltage	$V_{CE(sat)}$	$I_C=150A, V_{GE}=15V, T_{vj}=25^{\circ}C$		1.80	2.10	V
		$I_C=150A, V_{GE}=15V, T_{vj}=125^{\circ}C$		2.00		V
Input Capacitance	C_{ies}	$V_{CE}=25V, V_{GE}=0V, f=1MHz, T_{vj}=25^{\circ}C$		9.80		nF
Output Capacitance	C_{oes}			0.82		nF
Reverse Transfer Capacitance	C_{res}			0.48		nF
Internal Gate Resistance	R_{gint}			2.5		Ω
Turn-on Delay Time	$t_{d(on)}$	$I_C=150A, V_{CE}=600V, V_{GE}=\pm 15V, R_G=5.1\Omega, T_{vj}=25^{\circ}C$		185		Ns
Rise Time	t_r			55		Ns
Turn-off Delay Time	$t_{d(off)}$			360		Ns
Fall Time	t_f			115		Ns
Energy Dissipation During Turn-on Time	E_{on}			15.4		mJ
Energy Dissipation During Turn-off Time	E_{off}			11.6		mJ
Turn-on Delay Time	$t_{d(on)}$	$I_C=150A, V_{CE}=600V, V_{GE}=\pm 15V, R_G=5.1\Omega, T_{vj}=125^{\circ}C$		200		Ns
Rise Time	t_r			60		Ns
Turn-off Delay Time	$t_{d(off)}$			420		Ns
Fall Time	t_f			120		Ns
Energy Dissipation During Turn-on Time	E_{on}			23.2		mJ
Energy Dissipation During Turn-off Time	E_{off}			17.0		mJ
SC Data	I_{sc}	$T_p \leq 10\mu s, V_{GE}=15V, T_{vj}=150^{\circ}C, V_{ce}=600V, V_{CEM} \leq 1200V$		500		A

● Diode Characteristics

Parameter	Symbol	Conditions	Value			Unit
			Min.	Typ.	Max.	
Diode DC Forward Current	I_F	$T_c=100^\circ\text{C}$		150		A
Diode Peak Forward Current	I_{FRM}			300		A
Forward Voltage	V_F	$I_F=150\text{A}, T_{vj}=25^\circ\text{C}$		1.80	2.30	V
		$I_F=150\text{A}, T_{vj}=125^\circ\text{C}$		1.85		V

Parameter	Symbol	Conditions	Value			Unit
			Min.	Typ.	Max.	
Recovered Charge	Q_{rr}	$I_F = 150\text{ A}$ $V_R=600\text{V}$ $-di_F/dt = 2200\text{A/us}$ $T_{vj}=25^\circ\text{C}$		13.4		μC
Peak Reverse Recovery Current	I_{rr}			143		A
Reverse Recovery Time	t_{rr}			160		ns
Reverse Recovery Energy	E_{rec}			9.1		mJ
Recovered Charge	Q_{rr}	$I_F = 150\text{ A}$ $V_R=600\text{V}$ $-di_F/dt = 2200\text{A/us}$ $T_{vj}=125^\circ\text{C}$		26.1		μC
Peak Reverse Recovery Current	I_{rr}			178		A
Reverse Recovery Time	t_{rr}			440		ns
Reverse Recovery Energy	E_{rec}			15.4		mJ

● Module Characteristics $T_C=25^{\circ}\text{C}$ unless otherwise specified

Parameter	Symbol	Conditions	Value			Unit
			Min.	Typ.	Max.	
Isolation voltage	V_{isol}	$t=1\text{min}, f=50\text{Hz}$	2500			V
Maximum Junction Temperature	T_{jmax}				150	$^{\circ}\text{C}$
Operating Junction Temperature	T_{vjop}		-40		125	$^{\circ}\text{C}$
Storage Temperature	T_{stg}		-40		125	$^{\circ}\text{C}$
Junction-to Case	$R_{\theta jc}$	per IGBT-inverter			0.155	K/W
		per Diode-inverter			0.292	K/W
Case to Sink	$R_{\theta cs}$	Conductive grease applied		0.05		K/W
Module Electrodes Torque	M_t	Recommended(M5)	2.5		5.0	N·m
Module-to-Sink Torque	M_s	Recommended(M6)	3.0		5.0	N·m
Weight of Module	G			150		g

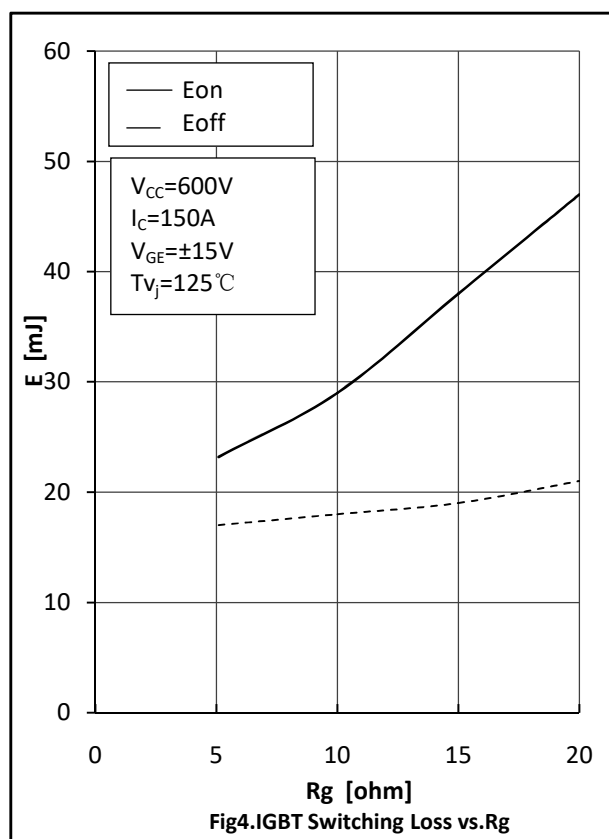
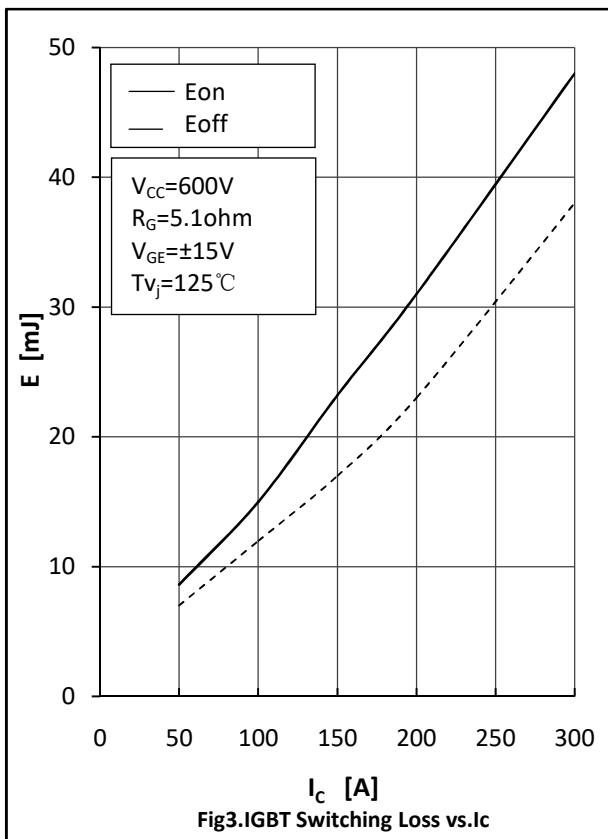
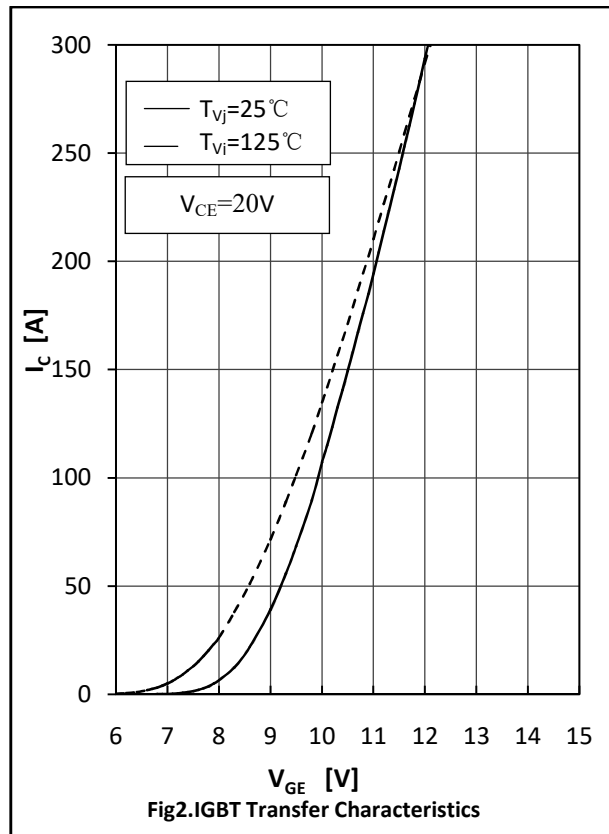
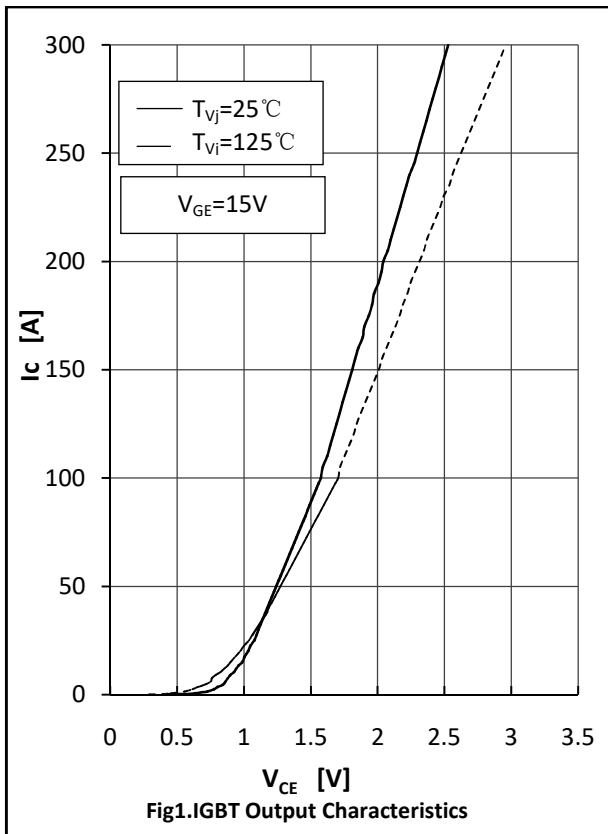

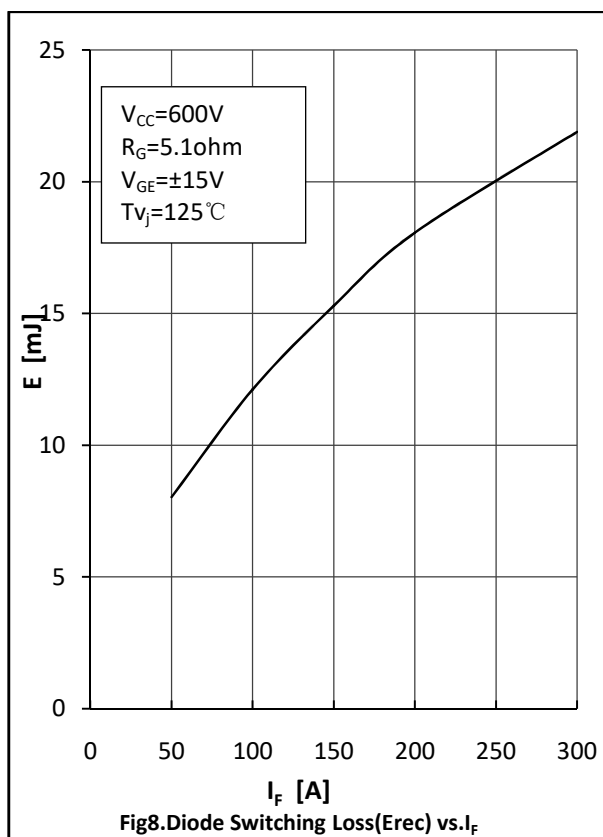
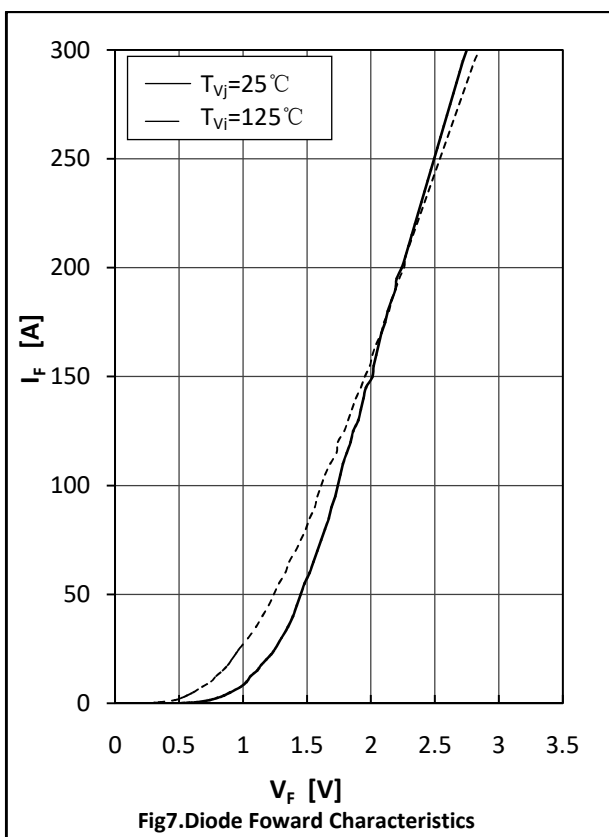
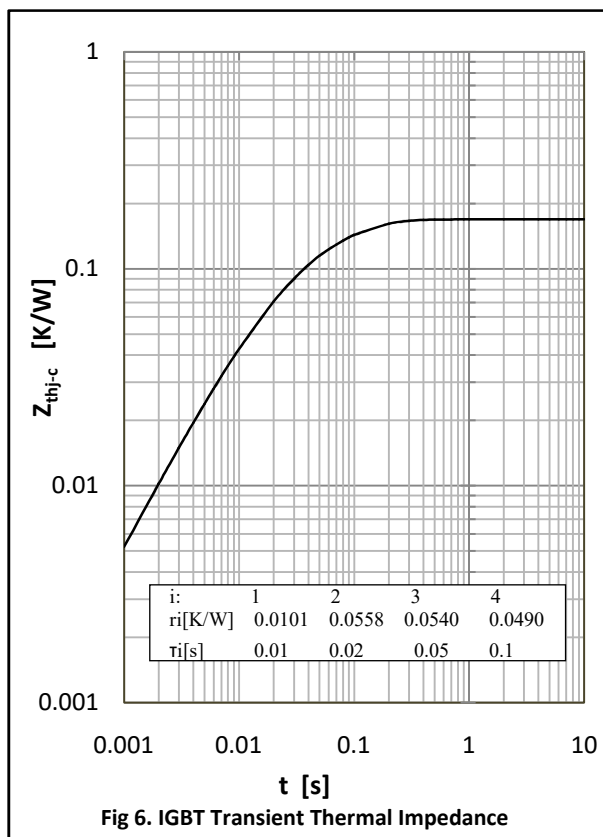
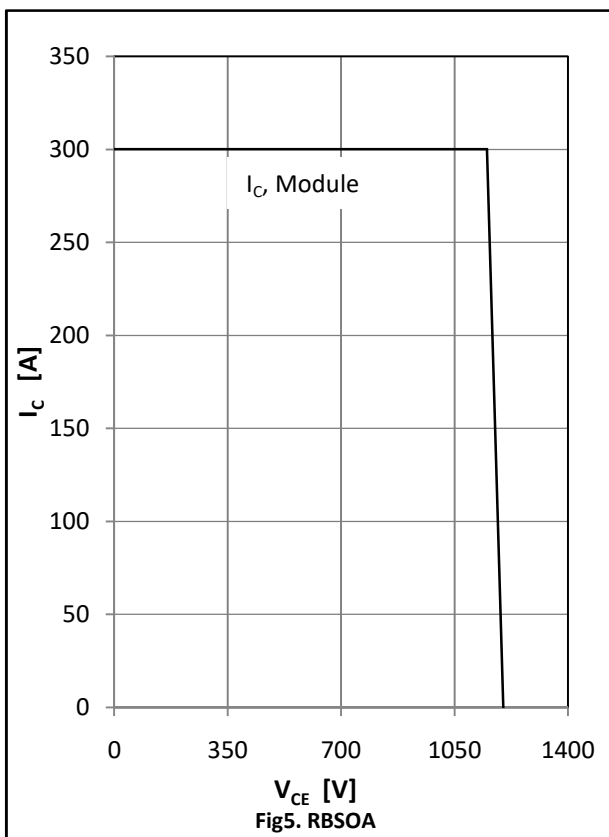

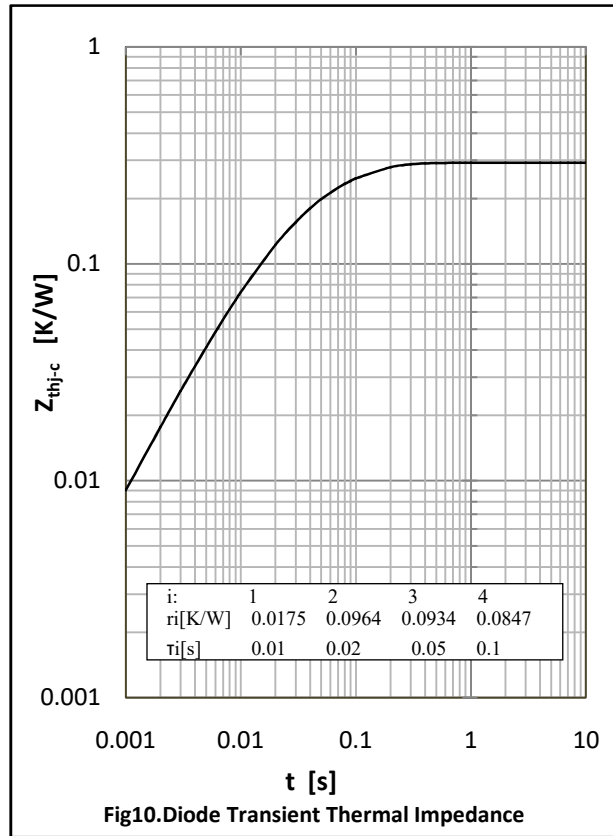
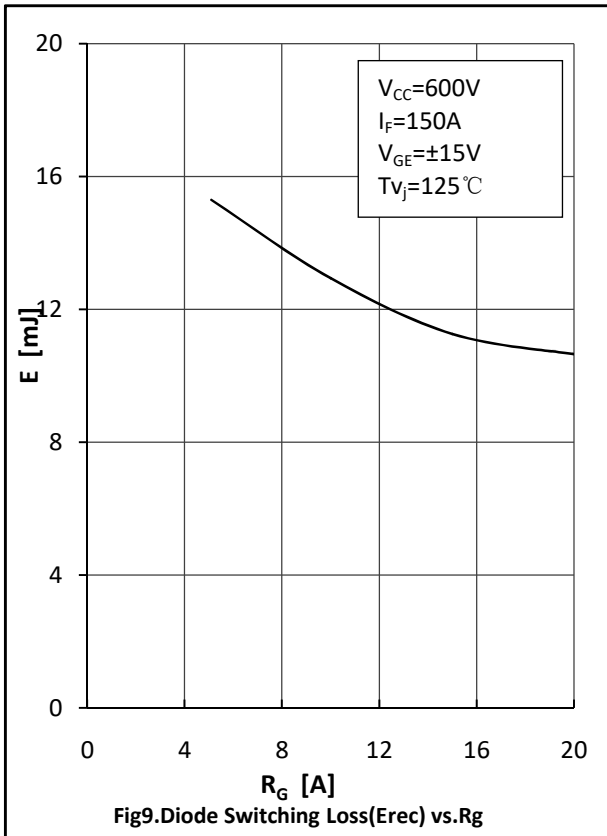

● Circuit Diagram

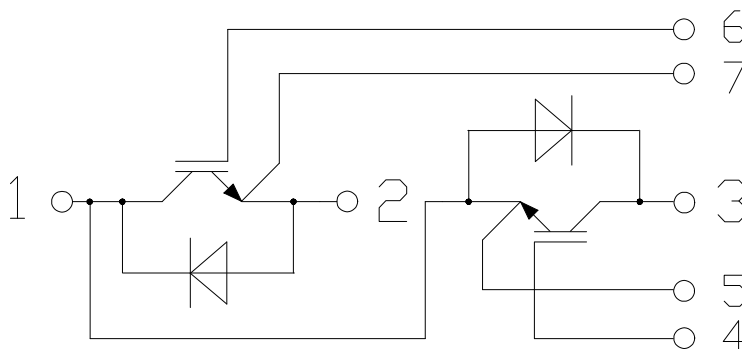

● Package Dimensions

Dimensions in Millimeters

