

伺服连接器 SERVO CONNECTOR

伺服连接器

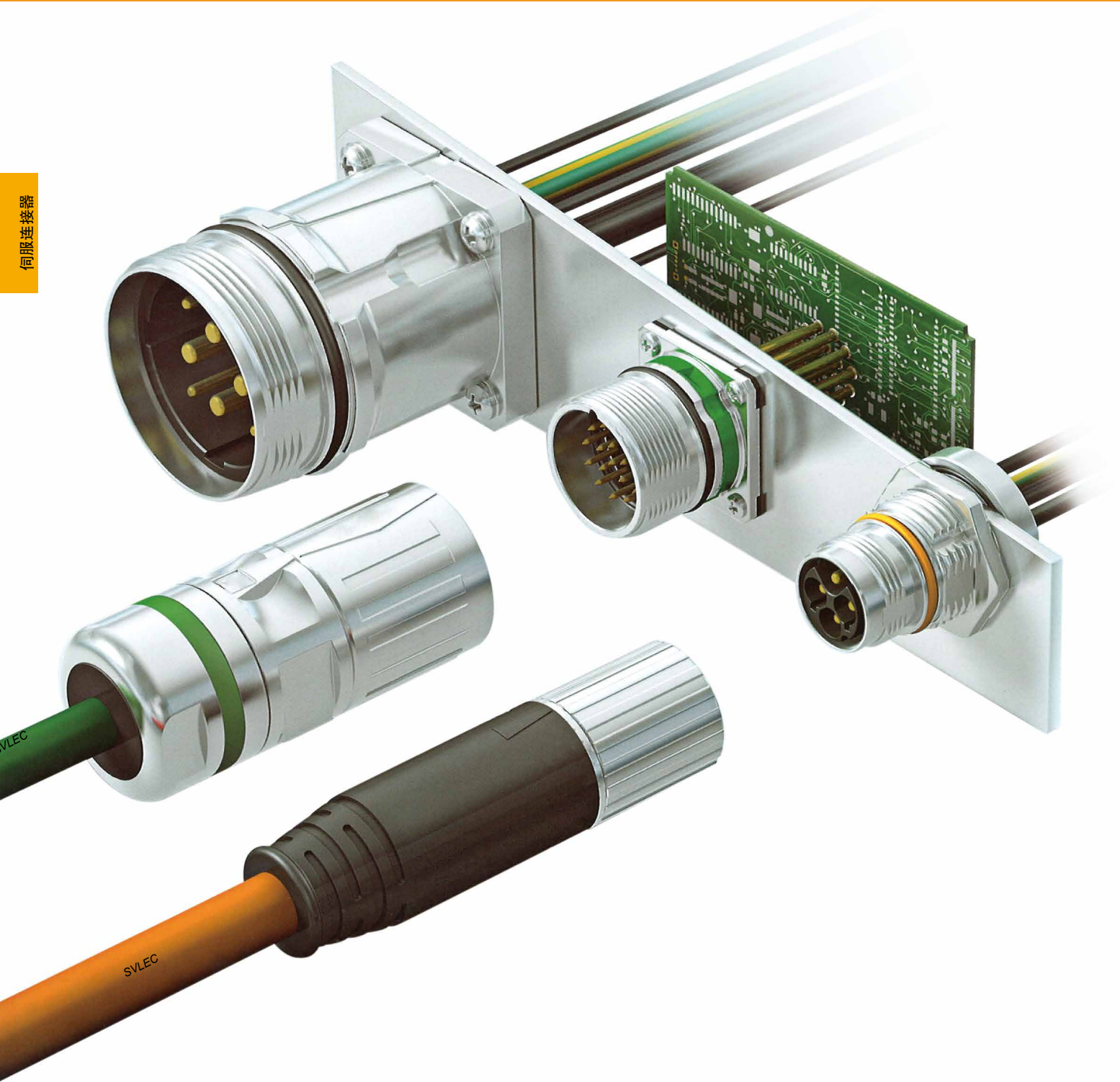

第十章 Chapter 10

M23 M40 连接器 Connect



M23 M40 接头 Connect



伺服线束
Servo applications

- 10.1 M23 信号连接器 Signal connector
- 10.2 M23 动力连接器 Power connector
- 10.3 M40 动力连接器 Power connector
- 10.4 伺服驱动连接动力线束
Servo and power drive systems
- 10.5 伺服驱动连接信号线束
Servo drive connection signal cable
- 10.6 V90 伺服线束 Servo applications

连接器定义形式 CONNECTOR DEFINITION FORM

圆形连接器型号定义 Round plug connectors

RC - M23 - S BS - 12 M - CW - A - F

系列号 Series

规格 Specification

M17
M23
M40

类型 Type

S = 信号 Signal
P = 动力 Power

出线方式 Terminations technology

PS = 插头直出 Plug straight
PR = 插头 Plug 90°
BS = 插座直出 Socket straight
BR = 插座 Socket 90°
CC = 线对线 Cable to cable

极数 Suppression

6 针 pole
8 针 pole
9 针 pole
12 针 pole
17 针 pole
19 针 pole
⋮
⋮

接口 Interface

M= 公头 Male
F= 母头 Female

固定方式 Fixed mode
(仅限于插座)
(Only for socket)

F = 法兰安装座
Flange installation
N = 螺母安装座
Nut mounting base
S = PCB 板焊接
Solder pins

电缆出线范围 (仅限于插头)
Wire diameter (Only for plug)

A = 5-10mm
B = 7-12mm
C = 9-14mm
D = 13-18mm
E = 17-24mm
F = 21-28mm

} 仅限于
Only for M23

排列顺序 (仅限于信号连接器)
Contact layout (Only for signal connectors)

CW = 顺时针 clockwise
CCW= 逆时针 counterclockwise

M23 连接器 CONNECTOR

M23 信号直型接插件安装方式 Installation Mode of Signal Direct Connector

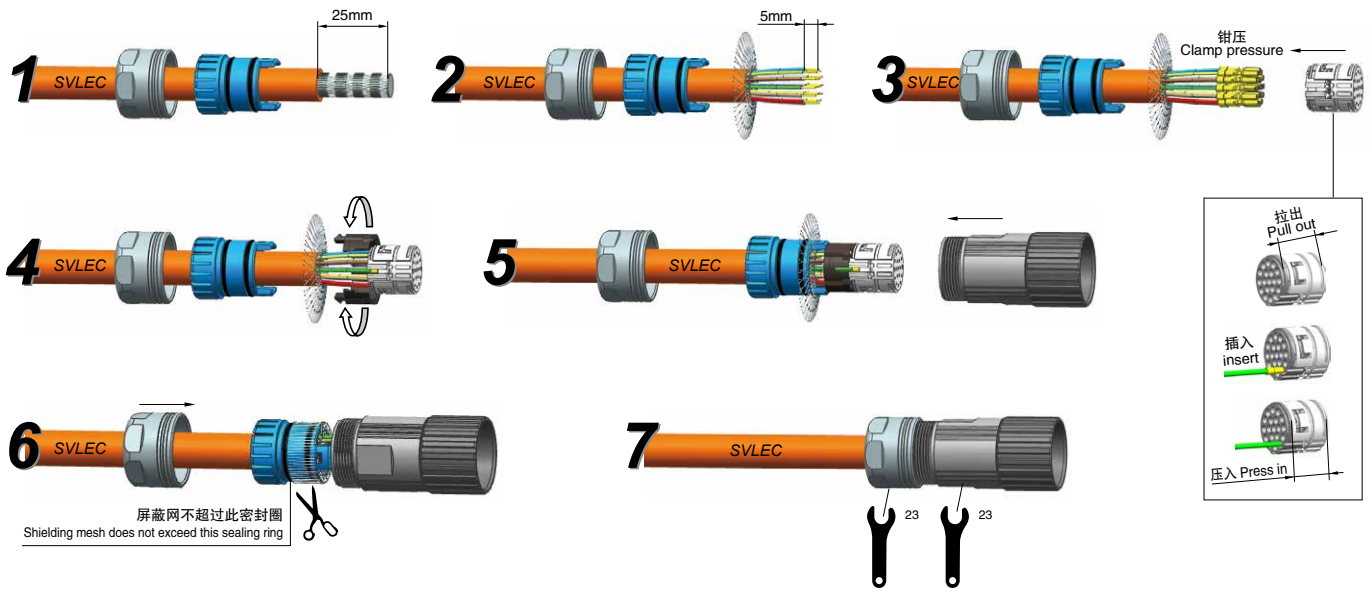

伺服连接器

M23 信号板面接插件安装方式 Installation Method of Signal Board Surface Connector

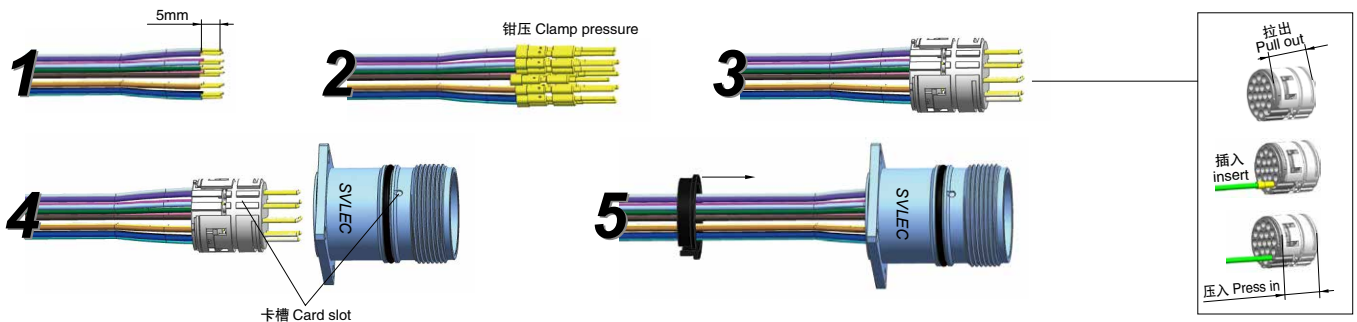

M23 动力直型接插件安装方式 Installation Mode of Power Direct Connector

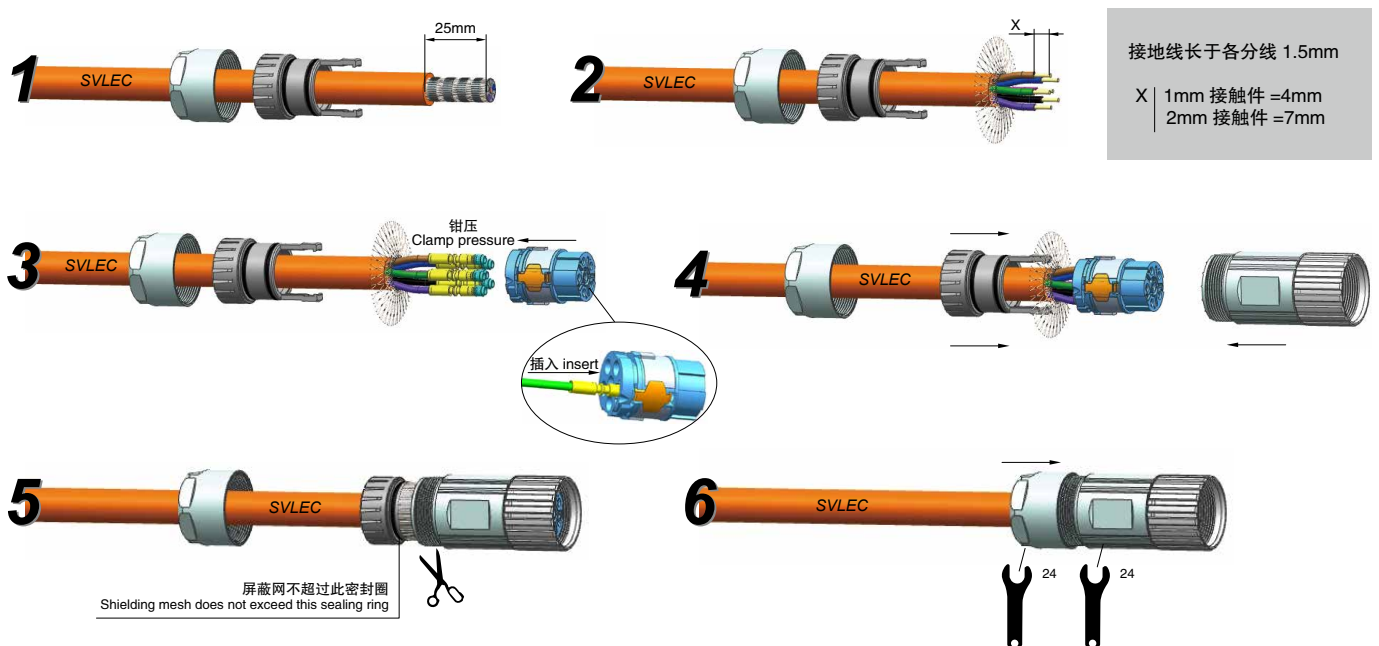

M23 连接器 CONNECTOR

现场接线
Field-wireable

M23 圆形连接器 Round plug connector (9,12)-pole
插孔 直出线 Female straight



M23 信号连接器

1	螺纹型号 Form No.	923091	923092	923093	923094	923121	923122
		RC-M23-SPS-9F-CW	RC-M23-SPS-9F-CW	RC-M23-SPS-(8+1)F-CW	RC-M23-SPS-(8+1)F-CW	RC-M23-SPS-12F-CW	RC-M23-SPS-12F-CW
	快锁型号 Form No.	923091Q	923092Q	923093Q	923094Q	923121Q	923122Q
	极数 Suppression	9xØ1mm	9xØ1mm	8x1mm+1x2mm	8x1mm+1x2mm	12xØ1mm	12xØ1mm
		9-pole	9-pole	9-pole	9-pole	12-pole	12-pole

尺寸图 Description

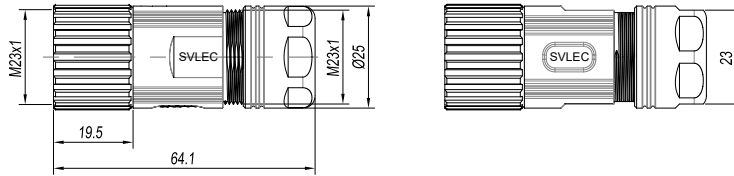

压线范围 Wire diameter

7-14mm

针脚排序
Contact layout

插孔 Female	插孔 Female	插孔 Female	插孔 Female	插孔 Female	插孔 Female	插孔 Female
逆时针 counterclockwise	顺时针 clockwise	逆时针 counterclockwise	顺时针 clockwise	逆时针 counterclockwise	顺时针 clockwise	

2 技术参数 Technical data

额定电压 Supply voltage	160 V AC/DC
额定电流 Current per contact	10A
防护等级 Protection	IP67- 插孔插针配合拧紧 When plugged and screwed down
温度范围 Temperature range	-20...+130°C
测试电压 (两插针之间) Test voltage	2500V
外壳材料 Housing material	锌合金压铸件 黄铜, 镀镍 Zinc alloy die casting Brass, nickel plating
绝缘内嵌体材料 Insulation embedded body material	PA66/PBT, UL 94/V0

接触件 (插孔)
Contact element (female)



类型 Type	压线范围 Wire diameter	订货号 Part No.
插孔 Female Ø1mm	0.03-0.34mm ²	916201
	0.14-1.00mm ²	916221
插孔 Female Ø2mm	0.50-1.50mm ²	916231
	0.50-1.50mm ²	956221

订货号 Part No.

1 型号 Form



备注 Notes

M23 连接器 CONNECTOR

现场接线
Field-wireable

M23 圆形连接器 Round plug connector (17,16+3)-pole
插孔 直出线 Female straight



1	螺纹型号 Form No.	923171	923172	923191	923192															
		RC-M23-SPS-17F-CCW	RC-M23-SPS-17F-CW	RC-M23-SPS-19F-CCW	RC-M23-SPS-19F-CW															
	快锁型号 Form	923171Q	923172Q	923191Q	923192Q															
	极数 Suppression	17xØ1mm 17-pole	17xØ1mm 17-pole	16xØ1mm+3xØ1.5mm 19-pole	16xØ1mm+3xØ1.5mm 19-pole															
尺寸图 Description																				
压线范围 Wire diameter		7-14mm																		
针脚排序 Contact layout		<p>插孔 Female 逆时针 counterclockwise</p>	<p>插孔 Female 顺时针 clockwise</p>	<p>插孔 Female 逆时针 counterclockwise</p>	<p>插孔 Female 顺时针 clockwise</p>															
2 技术参数 Technical data																				
额定电压 Supply voltage		160 V AC/DC		125 V AC/DC																
额定电流 Current per contact		8A																		
防护等级 Protection		IP67- 插孔插针配合拧紧 When plugged and screwed down																		
温度范围 Temperature range		-20...+130°C																		
测试电压 (两插针之间) Test voltage		2500V																		
外壳材料 Housing material		锌合金压铸件 黄铜, 镀镍 Zinc alloy die casting Brass, nickel plating																		
绝缘内嵌体材料 Insulation embedded body material		PA66/PBT, UL 94/V0																		
接触件 (插孔) Contact element (female)		 Ø1mm  Ø1.5mm	<table border="1"> <thead> <tr> <th>类型 Type</th> <th>压线范围 Wire diameter</th> <th>订货号 Part No.</th> </tr> </thead> <tbody> <tr> <td rowspan="3">插孔 Female Ø1mm</td> <td>0.03~0.34mm²</td> <td>916201</td> </tr> <tr> <td>0.14~1.00mm²</td> <td>916221</td> </tr> <tr> <td>0.50~1.50mm²</td> <td>916231</td> </tr> <tr> <td rowspan="2">插孔 Female Ø1.5mm</td> <td>0.24~1.00mm²</td> <td>936201</td> </tr> <tr> <td>0.50~1.50mm²</td> <td>936221</td> </tr> </tbody> </table>	类型 Type	压线范围 Wire diameter	订货号 Part No.	插孔 Female Ø1mm	0.03~0.34mm ²	916201	0.14~1.00mm ²	916221	0.50~1.50mm ²	916231	插孔 Female Ø1.5mm	0.24~1.00mm ²	936201	0.50~1.50mm ²	936221		
类型 Type	压线范围 Wire diameter	订货号 Part No.																		
插孔 Female Ø1mm	0.03~0.34mm ²	916201																		
	0.14~1.00mm ²	916221																		
	0.50~1.50mm ²	916231																		
插孔 Female Ø1.5mm	0.24~1.00mm ²	936201																		
	0.50~1.50mm ²	936221																		
订货号 Part No.		<div style="text-align: center;"> _____ - _____ - _____ </div>																		
		1 型号 Form																		
备注 Notes																				

M23 连接器 CONNECTOR

现场接线
Field-wireable

M23 圆形连接器 Round plug connector (9,12)-pole
插针 Male 90° 法兰安装 Flange installation



M23 信号连接器

1 螺纹型号 Form No.	923491	923495	923492	923497	923421	923422
	RC-M23-SBR-9M-CCW-F	RC-M23-SBR-(8+1)M-CCW-F	RC-M23-SBR-9M-CW-F	RC-M23-SBR-(8+1)M-CW-F	RC-M23-SBR-12M-CCW-F	RC-M23-SBR-12M-CW-F
极数 Suppression	9xØ1mm 9-pole	8x1mm+1x2mm 9-pole	9xØ1mm 9-pole	8x1mm+1x2mm 9-pole	12xØ1mm 12-pole	12xØ1mm 12-pole

尺寸图 Description

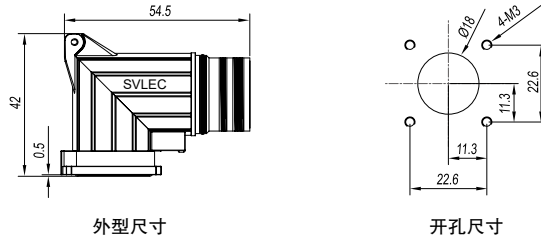

针脚排序
Contact layout

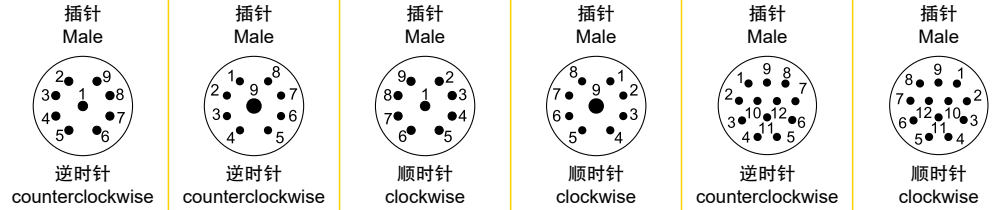

2 技术参数 Technical data

额定电压 Supply voltage	160 V AC/DC
额定电流 Current per contact	10A
防护等级 Protection	IP67- 插孔插针配合拧紧 When plugged and screwed down
温度范围 Temperature range	-20...+130°C
测试电压 (两插针之间) Test voltage	2500V
外壳材料 Housing material	锌合金压铸件 黄铜, 镀镍 Zinc alloy die casting Brass, nickel plating
绝缘内嵌体材料 Insulation embedded body material	PA66/PBT, UL 94/V0

接触件 (插针)
Contact element (male)



类型 Type	压线范围 Wire diameter	订货号 Part No.
插针 Male Ø1mm	0.03-0.34mm ²	916101
	0.14-1.00mm ²	916121
插针 Male Ø2mm	0.50-1.50mm ²	916131
	0.50-1.50mm ²	956121

订货号 Part No.

1 型号 Form

备注 Notes

M23 连接器 CONNECTOR

现场接线
Field-wireable

M23 圆形连接器 Round plug connector (17,16+3)-pole
插针 Male 90° 法兰安装 Flange installation



1	螺纹型号 Form No.	923471	923472	923493	923494
		RC-M23-SBR-17M-CCW-F	RC-M23-SBR-17M-CW-F	RC-M23-SBR-19M-CCW-F	RC-M23-SBR-19M-CW-F
	极数 Suppression	17xØ1mm 17-pole	17xØ1mm 17-pole	16xØ1mm+3xØ1.5mm 19-pole	16xØ1mm+3xØ1.5mm 19-pole

尺寸图 Description

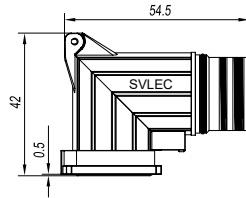

外型尺寸

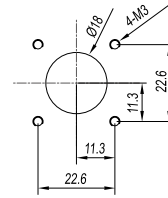

开孔尺寸

针脚排序
Contact layout

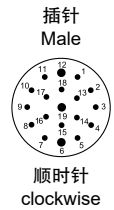
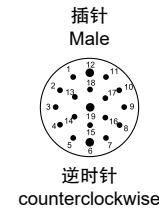
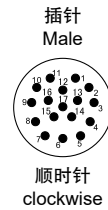
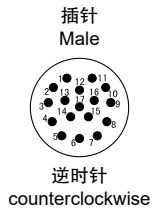

2	技术参数 Technical data		
额定电压 Supply voltage	160 V AC/DC		125 V AC/DC
额定电流 Current per contact	8A		
防护等级 Protection	IP67- 插孔插针配合拧紧 When plugged and screwed down		
温度范围 Temperature range	-20...+130°C		
测试电压 (两插针之间) Test voltage	2500V		
外壳材料 Housing material	锌合金压铸件 黄铜, 镀镍 Zinc alloy die casting Brass, nickel plating		
绝缘内嵌体材料 Insulation embedded body material	PA66/PBT, UL 94/V0		

接触件 (插针)
Contact element (male)



类型 Type	压线范围 Wire diameter	订货号 Part No.
插针 Male Ø1mm	0.03-0.34mm ²	916101
	0.14-1.00mm ²	916121
	0.50-1.50mm ²	916131
插针 Male Ø1.5mm	0.24-1.00mm ²	936101
	0.50-1.50mm ²	936121

订货号 Part No.

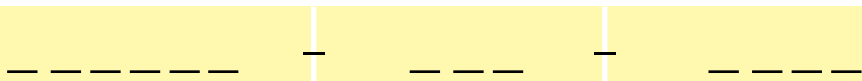

1 型号 Form

备注 Notes

M23 连接器 CONNECTOR

现场接线
Field-wireable

M23 圆形连接器 Round plug connector (9,12)-pole
插针 延长式连接器 Male Extended type connector



M23 信号连接器

1	螺纹型号 Form No.	923591	923595	923592	923597	923521	923522
		RC-M23-SCC-9M-CCW	RC-M23-SCC-(8+1)M-CCW	RC-M23-SCC-9M-CW	RC-M23-SCC-(8+1)M-CW	RC-M23-SCC-12M-CCW	RC-M23-SCC-12M-CW
	极数 Suppression	9xØ1mm 9-pole	8x1mm+1x2mm 9-pole	9xØ1mm 9-pole	8x1mm+1x2mm 9-pole	12xØ1mm 12-pole	12xØ1mm 12-pole

尺寸图 Description

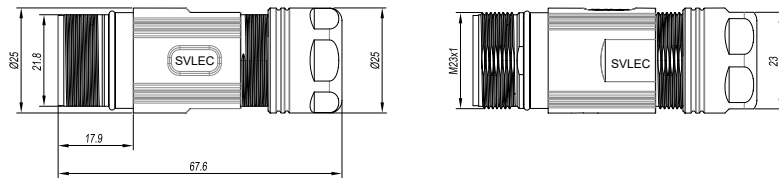

压线范围 Wire diameter

7-14mm

针脚排序
Contact layout

插针 Male	插针 Male	插针 Male	插针 Male	插针 Male	插针 Male	插针 Male
逆时针 counterclockwise	逆时针 counterclockwise	顺时针 clockwise	顺时针 clockwise	逆时针 counterclockwise	顺时针 clockwise	

2 技术参数 Technical data

额定电压 Supply voltage	160 V AC/DC
额定电流 Current per contact	10A
防护等级 Protection	IP67- 插孔插针配合拧紧 When plugged and screw down
温度范围 Temperature range	-20...+130°C
测试电压 (两插针之间) Test voltage	2500V
外壳材料 Housing material	锌合金压铸件 黄铜, 镀镍 Zinc alloy die casting Brass, nickel plating
绝缘内嵌体材料 Insulation embedded body material	PA66/PBT, UL 94/V0

接触件 (插针)
Contact element (male)



类型 Type	压线范围 Wire diameter	订货号 Part No.
插针 Male Ø1mm	0.03-0.34mm ²	916101
	0.14-1.00mm ²	916121
	0.50-1.50mm ²	916131
插针 Male Ø2mm	0.50-1.50mm ²	956121

订货号 Part No.

1 型号 Form

备注 Notes

M23 连接器 CONNECTOR

现场接线
Field-wireable

M23 圆形连接器 Round plug connector (17,19)-pole
插针 延长式连接器 Male Extended type connector



1 螺纹型号 Form No.	923571	923572	923593	923594
	RC-M23-SCC-17M-CCW	RC-M23-SCC-17M-CW	RC-M23-SCC-19M-CCW	RC-M23-SCC-19M-CW
极数 Suppression	17xØ1mm 17-pole	17xØ1mm 17-pole	16xØ1mm+3xØ1.5mm 19-pole	16xØ1mm+3xØ1.5mm 19-pole

尺寸图 Description

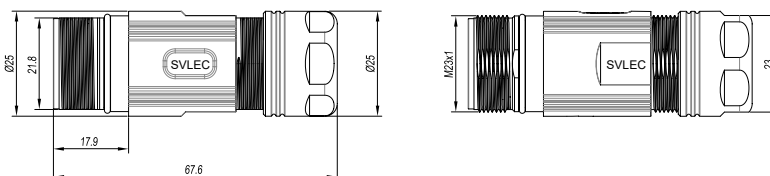

压线范围 Wire diameter 7-14mm

针脚排序
Contact layout

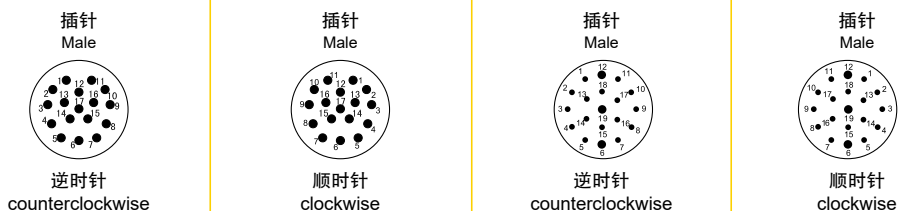

2 技术参数 Technical data

额定电压 Supply voltage	160 V AC/DC	125 V AC/DC
额定电流 Current per contact	8A	
防护等级 Protection	IP67- 插孔插针配合拧紧 When plugged and screwed down	
温度范围 Temperature range	-20...+130°C	
测试电压 (两插针之间) Test voltage	2500V	
外壳材料 Housing material	锌合金压铸件 黄铜, 镀镍 Zinc alloy die casting Brass, nickel plating	
绝缘内嵌体材料 Insulation embedded body material	PA66/PBT, UL 94/V0	

接触件 (插针)
Contact element (male)



类型 Type	压线范围 Wire diameter	订货号 Part No.
插针 Male Ø1mm	0.03-0.34mm ²	916101
	0.14-1.00mm ²	916121
	0.50-1.50mm ²	916131
插针 Male Ø1.5mm	0.24-1.00mm ²	936101
	0.50-1.50mm ²	936121

订货号 Part No.



1 型号 Form

备注 Notes

M23 连接器 CONNECTOR

现场接线
Field-wireable

M23 圆形连接器 Round plug connector (9,12)-pole
插针 中间固定式连接器 Male Fixed connector



M23 信号连接器

1	No.	923981	923983	923985	923987	923281	923283
型号 Form		RC-M23-SPF-9M-CCW	RC-M23-SPF-(8+1)M-CCW	RC-M23-SPF-9M-CW	RC-M23-SPF-(8+1)M-CW	RC-M23-SPF-12M-CCW	RC-M23-SPF-12M-CW
极数 Suppression		9xØ1mm	8x1mm+1x2mm	9xØ1mm	8x1mm+1x2mm	12xØ1mm	12xØ1mm
尺寸图 Description							
压线范围 Wire diameter		7-14mm					
针脚排序 Contact layout		<p>插针 Male 逆时针 counterclockwise</p>	<p>插针 Male 逆时针 counterclockwise</p>	<p>插针 Male 顺时针 clockwise</p>	<p>插针 Male 顺时针 clockwise</p>	<p>插针 Male 逆时针 counterclockwise</p>	<p>插针 Male 顺时针 clockwise</p>

2	技术参数 Technical data						
额定电压 Supply voltage	160 V AC/DC						
额定电流 Current per contact	10A					8A	
防护等级 Protection	IP67- 插孔插针配合拧紧 When plugged and screwed down						
温度范围 Temperature range	-20...+130°C						
测试电压 (两插针之间) Test voltage	2500V						
外壳材料 Housing material	锌合金压铸件 黄铜, 镀镍 Zinc alloy die casting Brass, nickel plating						
绝缘内嵌材料 Insulation embedded body material	PA66/PBT, UL 94/V0						

接触件 (插针)
Contact element (male)



类型 Type	压线范围 Wire diameter	订货号 Part No.
插针 Male Ø1mm	0.03-0.34mm ²	916101
	0.14-1.00mm ²	916121
	0.50-1.50mm ²	916131
插针 Male Ø2mm	0.50-1.50mm ²	956121

订货号 Part No.

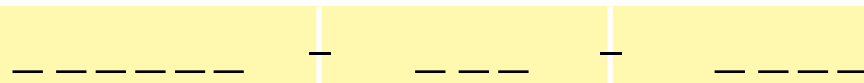

1 型号 Form







备注 Notes

M23 连接器 CONNECTOR

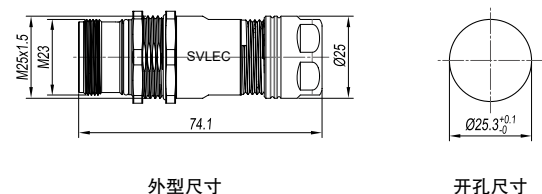
现场接线
Field-wireable

M23 圆形连接器 Round plug connector (17,19)-pole
插针 中间固定式连接器 Male Fixed connector



1	No.	923781	923783	923923	923925																					
型号 Form		RC-M23-SPF-17M-CCW	RC-M23-SPF-17M-CW	RC-M23-SPF-19M-CCW	RC-M23-SPF-19M-CW																					
极数 Suppression		17xØ1mm 17-pole	17xØ1mm 17-pole	16xØ1mm+3xØ1.5mm 19-pole	16xØ1mm+3xØ1.5mm 19-pole																					
尺寸图 Description	 <p>外形尺寸 开孔尺寸</p>																									
压线范围 Wire diameter	7-14mm																									
针脚排序 Contact layout	 <p>插针 Male 逆时针 counterclockwise</p>		 <p>插针 Male 顺时针 clockwise</p>		 <p>插针 Male 逆时针 counterclockwise</p>	 <p>插针 Male 顺时针 clockwise</p>																				
2 技术参数 Technical data	<table border="1"> <tr> <td>额定电压 Supply voltage</td> <td>160 V AC/DC</td> <td>125 V AC/DC</td> </tr> <tr> <td>额定电流 Current per contact</td> <td colspan="2">8A</td> </tr> <tr> <td>防护等级 Protection</td> <td colspan="2">IP67- 插孔插针配合拧紧 When plugged and screw down</td> </tr> <tr> <td>温度范围 Temperature range</td> <td colspan="2">-20...+130°C</td> </tr> <tr> <td>测试电压 (两插针之间) Test voltage</td> <td colspan="2">2500V</td> </tr> <tr> <td>外壳材料 Housing material</td> <td colspan="2">锌合金压铸件 黄铜, 镀镍 Zinc alloy die casting Brass, nickel plating</td> </tr> <tr> <td>绝缘内嵌体材料 Insulation embedded body material</td> <td colspan="2">PA66/PBT, UL 94/V0</td> </tr> </table>					额定电压 Supply voltage	160 V AC/DC	125 V AC/DC	额定电流 Current per contact	8A		防护等级 Protection	IP67- 插孔插针配合拧紧 When plugged and screw down		温度范围 Temperature range	-20...+130°C		测试电压 (两插针之间) Test voltage	2500V		外壳材料 Housing material	锌合金压铸件 黄铜, 镀镍 Zinc alloy die casting Brass, nickel plating		绝缘内嵌体材料 Insulation embedded body material	PA66/PBT, UL 94/V0	
额定电压 Supply voltage	160 V AC/DC	125 V AC/DC																								
额定电流 Current per contact	8A																									
防护等级 Protection	IP67- 插孔插针配合拧紧 When plugged and screw down																									
温度范围 Temperature range	-20...+130°C																									
测试电压 (两插针之间) Test voltage	2500V																									
外壳材料 Housing material	锌合金压铸件 黄铜, 镀镍 Zinc alloy die casting Brass, nickel plating																									
绝缘内嵌体材料 Insulation embedded body material	PA66/PBT, UL 94/V0																									
接触件 (插针) Contact element (male)	 <table border="1"> <thead> <tr> <th>类型 Type</th> <th>压线范围 Wire diameter</th> <th>订货号 Part No.</th> </tr> </thead> <tbody> <tr> <td rowspan="3">插针 Male Ø1mm</td> <td>0.03-0.34mm²</td> <td>916101</td> </tr> <tr> <td>0.14-1.00mm²</td> <td>916121</td> </tr> <tr> <td>0.50-1.50mm²</td> <td>916131</td> </tr> <tr> <td rowspan="2">插针 Male Ø1.5mm</td> <td>0.24-1.00mm²</td> <td>936101</td> </tr> <tr> <td>0.50-1.50mm²</td> <td>936121</td> </tr> </tbody> </table>					类型 Type	压线范围 Wire diameter	订货号 Part No.	插针 Male Ø1mm	0.03-0.34mm ²	916101	0.14-1.00mm ²	916121	0.50-1.50mm ²	916131	插针 Male Ø1.5mm	0.24-1.00mm ²	936101	0.50-1.50mm ²	936121						
类型 Type	压线范围 Wire diameter	订货号 Part No.																								
插针 Male Ø1mm	0.03-0.34mm ²	916101																								
	0.14-1.00mm ²	916121																								
	0.50-1.50mm ²	916131																								
插针 Male Ø1.5mm	0.24-1.00mm ²	936101																								
	0.50-1.50mm ²	936121																								
订货号 Part No.	<p>_____ - _____ - _____</p>																									
	<p>1 型号 Form</p>																									
备注 Notes																										

M23 信号连接器

M23 连接器 CONNECTOR

现场接线
Field-wireable
6-pole
3+PE+4-pole
3+PE+5-pole

插孔 Female
直出线 straight



1 螺纹型号 Form No.	923401	923601	923801	923901
	RC-M23-PPS-4F	RC-M23-PPS-6F	RC-M23-PPS-8F	RC-M23-PPS-9F
快锁型号 Form No.		923601Q	923801Q	
极数 Suppression	4p(4xØ2)	6p(6xØ2)	8p(4xØ2+4xØ1)	9p(4xØ2+5xØ1)

尺寸图 Description

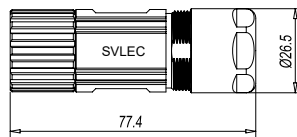

压线范围 Wire diameter 7-17mm

针脚排序 Contact layout

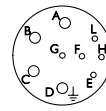
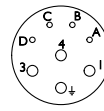
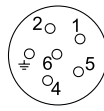
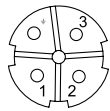

2 技术参数 Technical data

额定电压 Supply voltage	630 V AC/DC	630 V (AC/DC) / 250 V (AC/DC)
额定电流 Current per contact	28A	28A / 10A
防护等级 Protection	IP67- 插孔插针配合拧紧 When plugged and screwed down	
温度范围 Temperature range	-20...+130°C	
测试电压 (两插针之间) Test voltage	4000V	4000V / 2500V
外壳材料 Housing material	锌合金压铸件 黄铜, 镀镍 Zinc alloy die casting Brass, nickel plating	
绝缘内嵌体材料 Insulation embedded body material	PA66/PBT, UL 94/V0	

接触件 (插孔) Contact element (female)



Ø1mm



Ø2mm

类型 Type	压线范围 Wire diameter	订货号 Part No.
插孔 Female Ø1mm	0.25~1.00mm ²	916431
插孔 Female Ø2mm	1.00~2.50mm ²	926201
	2.50~4.00mm ²	926221

订货号 Part No.

1 型号 Form

备注 Notes

M23 动力连接器

M23 连接器 CONNECTOR

M23 圆形连接器
 Round plug connector

现场接线
 Field-wireable

6-pole

3+PE+4-pole



3+PE+5-pole

插针 Male 0°
 法兰安装 Flange installation



插针 Male 90°
 法兰安装 Flange installation

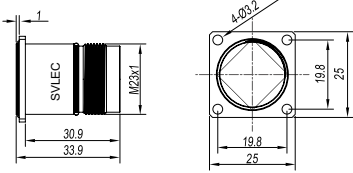
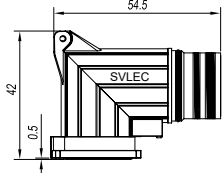
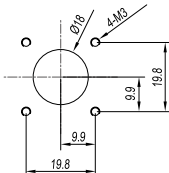
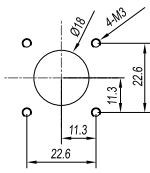
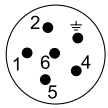
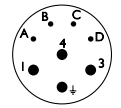
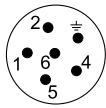
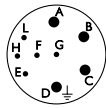

1	螺纹型号 Form No.	923621	923821	923921	923641	923841	923941											
		RC-M23-PBS-6M-F	RC-M23-PBS-8M-F	RC-M23-PBS-9M-F	RC-M23-PBR-6M-F	RC-M23-PBR-8M-F	RC-M23-PBR-9M-F											
极数 Suppression		6p(6xØ2)	8p(4xØ2+4xØ1)	9p(4xØ2+5xØ1)	6p(6xØ2)	8p(4xØ2+4xØ1)	9p(4xØ2+5xØ1)											
尺寸图 Description																		
开孔尺寸																		
针脚排序 Contact layout																		
2 技术参数 Technical data	6p(6xØ2)		8p(4xØ2+4xØ1)		9p(4xØ2+5xØ1)													
额定电压 Supply voltage	630 V AC/DC		630 V (AC/DC) / 250 V (AC/DC)		630 V (AC/DC) / 250 V (AC/DC)													
额定电流 Current per contact	30A		30A / 10A		30A / 10A													
防护等级 Protection	IP67- 插孔插针配合拧紧 When plugged and screw down																	
温度范围 Temperature range	-20...+130°C																	
测试电压 (两插针之间) Test voltage	6000V		6000V / 2500V		6000V / 2500V													
外壳材料 Housing material	锌合金压铸件 黄铜, 镀镍 Zinc alloy die casting Brass, nickel plating																	
绝缘内嵌体材料 Insulation embedded body material	PA66/PBT, UL 94/V0																	
接触件 (插针) Contact element (male)	 Ø1mm		 Ø2mm		<table border="1"> <thead> <tr> <th>类型 Type</th> <th>压线范围 Wire diameter</th> <th>订货号 Part No.</th> </tr> </thead> <tbody> <tr> <td>插针 Male Ø1mm</td> <td>0.25~1.00mm²</td> <td>916331</td> </tr> <tr> <td rowspan="2">插针 Male Ø2mm</td> <td>1.00~2.50mm²</td> <td>926101</td> </tr> <tr> <td>2.50~4.00mm²</td> <td>926121</td> </tr> </tbody> </table>			类型 Type	压线范围 Wire diameter	订货号 Part No.	插针 Male Ø1mm	0.25~1.00mm ²	916331	插针 Male Ø2mm	1.00~2.50mm ²	926101	2.50~4.00mm ²	926121
类型 Type	压线范围 Wire diameter	订货号 Part No.																
插针 Male Ø1mm	0.25~1.00mm ²	916331																
插针 Male Ø2mm	1.00~2.50mm ²	926101																
	2.50~4.00mm ²	926121																
订货号 Part No.	<div style="display: flex; justify-content: space-between; align-items: center;"> _____ _____ _____ </div>																	
	1 型号 Form																	
备注 Notes																		

M23 动力连接器

M23 连接器 CONNECTOR

现场接线
Field-wireable
6-pole
3+PE+4-pole
3+PE+5-pole

插针 延长式连接器 Male Extended type connector



1 螺纹型号 Form No.	923661	923881	923991
	RC-M23-PCC-6M-B	RC-M23-PCC-8M-B	RC-M23-PCC-9M-B
极数 Suppression	6p(6xØ2)	8p(4xØ2+4xØ1)	9p(4xØ2+5xØ1)

尺寸图 Description

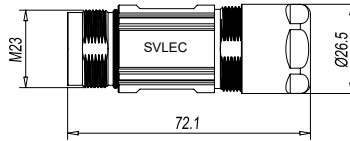

压线范围 Wire diameter 7-17mm

针脚排序
Contact layout

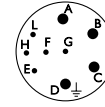
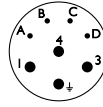
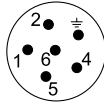

2 技术参数 Technical data

额定电压 Supply voltage	630 V AC/DC	630 V (AC/DC) / 250 V (AC/DC)
额定电流 Current per contact	28A	28A / 10A
防护等级 Protection	IP67- 插孔插针配合拧紧 When plugged and screwed down	
温度范围 Temperature range	-20...+130°C	
测试电压 (两插针之间) Test voltage	4000V	4000V / 2500V
外壳材料 Housing material	锌合金压铸件 黄铜, 镀镍 Zinc alloy die casting Brass, nickel plating	
绝缘内嵌体材料 Insulation embedded body material	PA66/PBT, UL 94/V0	

接触件 (插针)
Contact element (male)



类型 Type	压线范围 Wire diameter	订货号 Part No.
插针 Male Ø1mm	0.25~1.00mm ²	916331
插针 Male Ø2mm	1.00~2.50mm ²	926101
	2.50~4.00mm ²	926121

订货号 Part No.

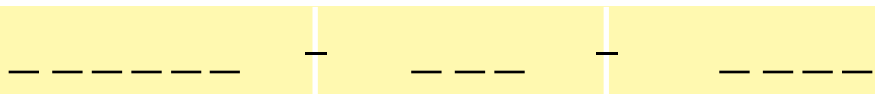

1 型号 Form

备注 Notes

M23 连接器 CONNECTOR

现场接线
Field-wireable

插针 Male
直出线 straight



1	No.	923688	923888													
	型号 Form	RC-M23-PPT-6M	RC-M23-PPT-8M													
	极数 Suppression	6-pole	8-pole													
	尺寸图 Description	<p>外型尺寸</p>														
	针脚排序 Contact layout															
2	技术参数 Technical data															
	额定电压 Supply voltage	630 V AC/DC														
	额定电流 Current per contact	30A														
	防护等级 Protection	IP67- 插孔插针配合拧紧 When plugged and screwed down														
	温度范围 Temperature range	-20...+130°C														
	测试电压 (两插针之间) Test voltage	2500V														
	外壳材料 Housing material	铜镀镍														
	绝缘内嵌体材料 Insulation embedded body material	PA66/PBT, UL 94/V0														
	接触件 (插针) Contact element (male)	<table border="1" style="width: 100%;"> <thead> <tr> <th>类型 Type</th> <th>压线范围 Wire diameter</th> <th>订货号 Part No.</th> </tr> </thead> <tbody> <tr> <td rowspan="3"> 插针 Male $\phi 1\text{mm}$ </td> <td>0.03-0.34mm²</td> <td>916101</td> </tr> <tr> <td>0.14-1.00mm²</td> <td>916121</td> </tr> <tr> <td>0.50-1.50mm²</td> <td>916131</td> </tr> <tr> <td> 插针 Male $\phi 2\text{mm}$ </td> <td>0.50-1.50mm²</td> <td>956121</td> </tr> </tbody> </table>		类型 Type	压线范围 Wire diameter	订货号 Part No.	 插针 Male $\phi 1\text{mm}$	0.03-0.34mm ²	916101	0.14-1.00mm ²	916121	0.50-1.50mm ²	916131	 插针 Male $\phi 2\text{mm}$	0.50-1.50mm ²	956121
类型 Type	压线范围 Wire diameter	订货号 Part No.														
 插针 Male $\phi 1\text{mm}$	0.03-0.34mm ²	916101														
	0.14-1.00mm ²	916121														
	0.50-1.50mm ²	916131														
 插针 Male $\phi 2\text{mm}$	0.50-1.50mm ²	956121														
	订货号 Part No.	<div style="display: flex; justify-content: space-around; align-items: center;"> <div style="border-bottom: 1px dashed black; width: 100px; height: 10px;"></div> <div style="border-bottom: 1px dashed black; width: 100px; height: 10px;"></div> <div style="border-bottom: 1px dashed black; width: 100px; height: 10px;"></div> </div>														
		1	型号 Form													
	备注 Notes															

M23 动力连接器

M40 连接器 CONNECTOR

M40 圆形连接器
Round plug connector

现场接线
Field-wireable

3+PE+2-pole

3+PE+4-pole

插孔 Female
直线 Straight



插孔 Female
直线 Straight



1 螺纹型号 Form No. **940661** **940681**

RC-M40-PPS-6F

RC-M40-PPS-8F

快锁型号 Form No. **940661Q** **940681Q**

极数 Suppression 6p(4 × Ø3.6+2 × Ø2) 8p(4 × Ø3.6+4 × Ø2)

尺寸图 Description

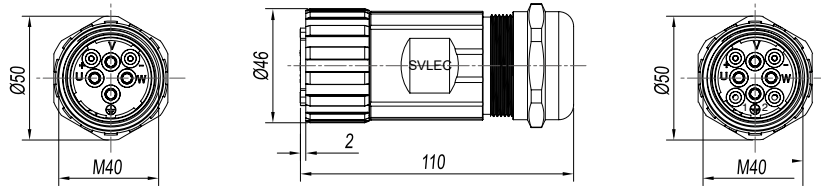

压线范围 Wire diameter 13-28mm

针脚排序
Contact layout

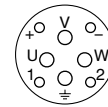
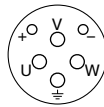

2 技术参数 Technical data

额定电压 Supply voltage	630 V (AC/DC) / 250 V (AC/DC)
额定电流 Current per contact	65A / 28A
防护等级 Protection	IP67- 插孔插针配合拧紧 When plugged and screwed down
温度范围 Temperature range	-20...+130°C
测试电压 (两插针之间) Test voltage	4000V / 2500V
外壳材料 Housing material	锌合金压铸件 黄铜, 镀镍 Zinc alloy die casting Brass, nickel plating
绝缘内嵌体材料 Insulation embedded body material	PA66/PBT, UL 94/V0

接触件 (插孔)
Contact element (female)



类型 Type	压线范围 Wire diameter	订货号 Part No.
插孔 Female Ø2mm	1.00-2.50mm ²	906201
	2.50-4.00mm ²	906221
插孔 Female Ø3.6mm	1.50-4.00mm ²	936241
	6.00mm ²	936261
	10.00mm ²	936281

订货号 Part No.

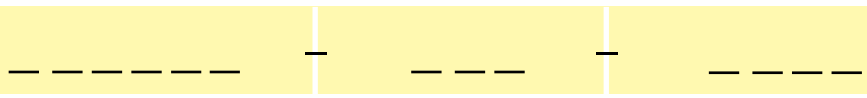

1 型号 Form

备注 Notes

M40 连接器 CONNECTOR



M40 圆形连接器
 Round plug connector M40
 现场接线
 Field-wireable
 3+PE+2-pole

插针 Male 0°
 法兰安装 Flange installation



插针 Male 90°
 法兰安装 Flange installation

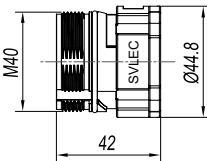
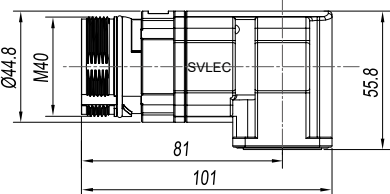
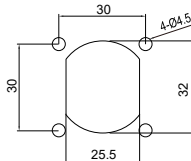
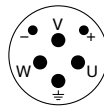

1	No.	940631	940651															
型号 Form		RC-M40-PBS-6M-F	RC-M40-PBR-6M-F															
极数 Suppression		6p(4 × Ø3.6+2 × Ø2)	6p(4 × Ø3.6+2 × Ø2)															
尺寸图 Description																		
开孔尺寸																		
针脚排序 Contact layout																		
2	技术参数 Technical data																	
额定电压 Supply voltage	630 V (AC/DC) / 250 V (AC/DC)																	
额定电流 Current per contact	65A / 28A																	
防护等级 Protection	IP67- 插孔插针配合拧紧 When plugged and screwed down																	
温度范围 Temperature range	-20...+130°C																	
测试电压 (两插针之间) Test voltage	4000V / 2500V																	
外壳材料 Housing material	锌合金压铸件 黄铜, 镀镍 Zinc alloy die casting Brass, nickel plating																	
绝缘内嵌体材料 Insulation embedded body material	PA66/PBT, UL 94/V0																	
接触件 (插针) Contact element (male)	 Ø2mm  Ø3.6mm	<table border="1"> <thead> <tr> <th>类型 Type</th> <th>压线范围 Wire diameter</th> <th>订货号 Part No.</th> </tr> </thead> <tbody> <tr> <td rowspan="2">插针 Male Ø2mm</td> <td>1.00-2.50mm²</td> <td>906101</td> </tr> <tr> <td>2.50-4.00mm²</td> <td>906121</td> </tr> <tr> <td rowspan="3">插针 Male Ø3.6mm</td> <td>1.50-4.00mm²</td> <td>936141</td> </tr> <tr> <td>6.00mm²</td> <td>936161</td> </tr> <tr> <td>10.00mm²</td> <td>936181</td> </tr> </tbody> </table>	类型 Type	压线范围 Wire diameter	订货号 Part No.	插针 Male Ø2mm	1.00-2.50mm ²	906101	2.50-4.00mm ²	906121	插针 Male Ø3.6mm	1.50-4.00mm ²	936141	6.00mm ²	936161	10.00mm ²	936181	
类型 Type	压线范围 Wire diameter	订货号 Part No.																
插针 Male Ø2mm	1.00-2.50mm ²	906101																
	2.50-4.00mm ²	906121																
插针 Male Ø3.6mm	1.50-4.00mm ²	936141																
	6.00mm ²	936161																
	10.00mm ²	936181																
订货号 Part No.	_____ - _____ - _____																	
	1	型号 Form																
备注 Notes																		

M40 连接器 CONNECTOR



M40 圆形连接器
Round plug connector M40
现场接线
Field-wireable
3+PE+4-pole

插针 Male 0°
法兰安装 Flange installation



插针 Male 90°
法兰安装 Flange installation

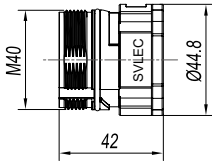
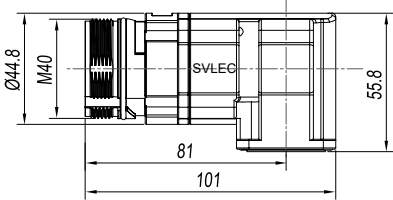
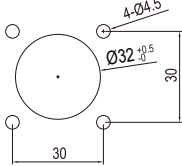
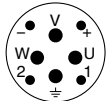

1	No.	940851	940871															
型号 Form	RC-M40-PBS-8M-F	RC-M40-PBR-8M-F																
极数 Suppression	8p(4 × Ø3.6+4 × Ø2)	8p(4 × Ø3.6+4 × Ø2)																
尺寸图 Description																		
开孔尺寸																		
针脚排序 Contact layout																		
2	技术参数 Technical data																	
额定电压 Supply voltage	630 V (AC/DC) / 250 V (AC/DC)																	
额定电流 Current per contact	65A / 28A																	
防护等级 Protection	IP67- 插孔插针配合拧紧 When plugged and screwed down																	
温度范围 Temperature range	-20...+130°C																	
测试电压 (两插针之间) Test voltage	4000V / 2500V																	
外壳材料 Housing material	锌合金压铸件 黄铜, 镀镍 Zinc alloy die casting Brass, nickel plating																	
绝缘内嵌体材料 Insulation embedded body material	PA66/PBT, UL 94/V0																	
接触件 (插针) Contact element (male)	 Ø2mm  Ø3.6mm	<table border="1"> <thead> <tr> <th>类型 Type</th> <th>压线范围 Wire diameter</th> <th>订货号 Part No.</th> </tr> </thead> <tbody> <tr> <td rowspan="2">插针 Male Ø2mm</td> <td>1.00-2.50mm²</td> <td>906101</td> </tr> <tr> <td>2.50-4.00mm²</td> <td>906121</td> </tr> <tr> <td rowspan="3">插针 Male Ø3.6mm</td> <td>1.50-4.00mm²</td> <td>936141</td> </tr> <tr> <td>6.00mm²</td> <td>936161</td> </tr> <tr> <td>10.00mm²</td> <td>936181</td> </tr> </tbody> </table>	类型 Type	压线范围 Wire diameter	订货号 Part No.	插针 Male Ø2mm	1.00-2.50mm ²	906101	2.50-4.00mm ²	906121	插针 Male Ø3.6mm	1.50-4.00mm ²	936141	6.00mm ²	936161	10.00mm ²	936181	
类型 Type	压线范围 Wire diameter	订货号 Part No.																
插针 Male Ø2mm	1.00-2.50mm ²	906101																
	2.50-4.00mm ²	906121																
插针 Male Ø3.6mm	1.50-4.00mm ²	936141																
	6.00mm ²	936161																
	10.00mm ²	936181																
订货号 Part No.	<div style="border: 1px dashed black; height: 40px; width: 100%;"></div>																	
	1	型号 Form																
备注 Notes																		

M40 连接器

M40 圆形电源连接器 CONNECTOR

M40 圆形连接器
 Round plug connector M40







现场接线
 Field-wireable

3+PE+2-pole

3+PE+4-pole

插针 Male
 延长式 Extended type connector

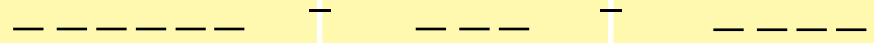

1	No.	940611	940811															
型号 Form		RC-M40-PCC-6M-B	RC-M40-PCC-8M-B															
极数 Suppression		6p(4 × Ø3.6+2 × Ø2)	8p(4 × Ø3.6+4 × Ø2)															
尺寸图 Description																		
压线范围 Wire diameter		13-28mm																
针脚排序 Contact layout																		
2	技术参数 Technical data																	
额定电压 Supply voltage		630 V (AC/DC) / 250 V (AC/DC)																
额定电流 Current per contact		75A / 30A																
防护等级 Protection		IP67- 插孔插针配合拧紧 When plugged and screwd down																
温度范围 Temperature range		-20...+130°C																
测试电压 (两插针之间) Test voltage		4000V / 2500V																
外壳材料 Housing material		锌合金压铸件 黄铜, 镀镍 Zinc alloy die casting Brass, nickel plating																
绝缘内嵌体材料 Insulation embedded body material		PA66/PBT, UL 94/V0																
接触件 (插针) Contact element (male)		<table border="1"> <thead> <tr> <th>类型 Type</th> <th>压线范围 Wire diameter</th> <th>订货号 Part No.</th> </tr> </thead> <tbody> <tr> <td rowspan="2">  Ø2mm 插针 Male Ø2mm </td> <td>1.00-2.50mm²</td> <td>926101</td> </tr> <tr> <td>2.50-4.00mm²</td> <td>926121</td> </tr> <tr> <td rowspan="3">  Ø3.6mm 插针 Male Ø3.6mm </td> <td>1.50-4.00mm²</td> <td>936141</td> </tr> <tr> <td>6.00mm²</td> <td>936161</td> </tr> <tr> <td>10.00mm²</td> <td>936181</td> </tr> </tbody> </table>		类型 Type	压线范围 Wire diameter	订货号 Part No.	 Ø2mm 插针 Male Ø2mm	1.00-2.50mm ²	926101	2.50-4.00mm ²	926121	 Ø3.6mm 插针 Male Ø3.6mm	1.50-4.00mm ²	936141	6.00mm ²	936161	10.00mm ²	936181
类型 Type	压线范围 Wire diameter	订货号 Part No.																
 Ø2mm 插针 Male Ø2mm	1.00-2.50mm ²	926101																
	2.50-4.00mm ²	926121																
 Ø3.6mm 插针 Male Ø3.6mm	1.50-4.00mm ²	936141																
	6.00mm ²	936161																
	10.00mm ²	936181																
订货号 Part No.		<div style="text-align: center;">  </div>																
		1	型号 Form															
备注 Notes																		

M23 伺服线束 SERVO APPLICATIONS

Siemens 标准
6FX5002 / 6 FX8002
系列动力控制电缆
Servo cable



1 螺纹型号 Form No. 923609																													
快锁型号 Form 923609Q																													
极数 Suppression	6-pole																												
Siemens 标准 6FX5002-5DN06-1BF																													
																													
2 螺纹型号 Form No. 923602																													
快锁型号 Form 923602Q																													
极数 Suppression	6-pole																												
2 电缆类型 Cable type	<table border="1"> <thead> <tr> <th>芯数 pole x 标称截面 mm² Number of cores and mm² per conductor</th> <th>高柔性电缆 Highly flexible</th> <th>固定安装电缆 Fixed installation</th> <th>外径 O.D</th> </tr> </thead> <tbody> <tr> <td>(4x1.5)C</td> <td>901</td> <td>902</td> <td>9.7</td> </tr> <tr> <td>(4x2.5)C</td> <td>903</td> <td>904</td> <td>11.1</td> </tr> <tr> <td>(4x4.0)C</td> <td>905</td> <td>906</td> <td>12.9</td> </tr> <tr> <td>(4x1.5+(2x1.0))C</td> <td>911</td> <td>912</td> <td>11.1</td> </tr> <tr> <td>(4x2.5+(2x0.75))C</td> <td>913</td> <td>914</td> <td>13.6</td> </tr> <tr> <td>(4x4.0+(2x1.0))C</td> <td>915</td> <td>916</td> <td>14.2</td> </tr> </tbody> </table>	芯数 pole x 标称截面 mm ² Number of cores and mm ² per conductor	高柔性电缆 Highly flexible	固定安装电缆 Fixed installation	外径 O.D	(4x1.5)C	901	902	9.7	(4x2.5)C	903	904	11.1	(4x4.0)C	905	906	12.9	(4x1.5+(2x1.0))C	911	912	11.1	(4x2.5+(2x0.75))C	913	914	13.6	(4x4.0+(2x1.0))C	915	916	14.2
芯数 pole x 标称截面 mm ² Number of cores and mm ² per conductor	高柔性电缆 Highly flexible	固定安装电缆 Fixed installation	外径 O.D																										
(4x1.5)C	901	902	9.7																										
(4x2.5)C	903	904	11.1																										
(4x4.0)C	905	906	12.9																										
(4x1.5+(2x1.0))C	911	912	11.1																										
(4x2.5+(2x0.75))C	913	914	13.6																										
(4x4.0+(2x1.0))C	915	916	14.2																										
动力线缆技术参数 Power cable technical data																													
符合 UL AWM style 20235 CSA																													
温度范围 Temperature range																													
挠曲 Flexing : -40°C to +80°C																													
静态 Fixed installation : -50°C to +90°C																													
额定电压 Nominal voltage																													
UL / CSA 1000V																													
VDE																													
动力线 Supply cores : U ₀ / U 600 / 1000V																													
控制线 Control cores : U ₀ / U 300 / 500V																													
3 电缆长度 Cable length																													
1.5m	0150																												
3.0m	0300																												
5.0m	0500																												
7.5m	0750																												
10.0m	1000																												
订货号 Part No.																													
例: 923609 - 901 - 0500																													
1 型号 Form	2 电缆类型 Cable type 3 电缆长度 Cable length																												
备注 Notes																													
电缆参数 Cable parameter: 10.6.6 配件及技术页面 Accessories and technical page: 10.6.4 不同的电缆长度可根据实际需要, 在订货号的第三部分自行修改, 电缆长度单位: cm																													

伺服动力线束

M40 伺服线束 SERVO APPLICATIONS

系列动力控制电缆
Servo cable



1	螺纹型号 Form No.	940609
	快锁型号 Form	940609Q
	极数 Suppression	6-pole



	螺纹型号 Form No.	940602
	快锁型号 Form	940602Q
	极数 Suppression	6-pole

2	电缆类型 Cable type	芯数 pole x 标称截面 mm ² Number of cores and mm ² per conductor	高柔性电缆 Highly flexible	固定安装电缆 Fixed installation	外径 O.D
		动力线缆技术参数 Power cable technical data 符合 UL AWM style 20235 CSA	(4x1.5)C	901	902
温度范围 Temperature range 挠曲 Flexing : -40°C to +80°C 静态 Fixed installation : -50°C to +90°C	(4x2.5)C	903	904	11.1	
额定电压 Nominal voltage UL / CSA 1000V VDE	(4x4.0)C	905	906	12.9	
动力线 Supply cores : U ₀ / U 600 / 1000V 控制线 Control cores : U ₀ / U 300 / 500V	(4x6.0)C	907	908	15.2	
	(4x1.5+(2x1.0))C	911	912	11.1	
	(4x2.5+(2x0.75))C	913	914	13.6	
	(4x4.0+(2x1.0))C	915	916	14.2	
	(4x6.0+(2x1.0))C	917	918	16.5	

3	电缆长度 Cable length	
	1.5m	0150
	3.0m	0300
	5.0m	0500
	7.5m	0750
	10.0m	1000

	订货号 Part No.	
	例: <u> 940609 </u> <u> 901 </u> <u> 0500 </u>	

1 型号 Form **2** 电缆类型 Cable type **3** 电缆长度 Cable length

备注 Notes
 电缆参数 Cable parameter: 10.6.6 配件及技术页面 Accessories and technical page: 10.6.4
 不同的电缆长度可根据实际需要, 在订货号的第三部分自行修改, 电缆长度单位: cm

伺服动力线束

M40 伺服线束 SERVO APPLICATIONS

主轴动力电缆
Spindle power cable



1 连接方式 The connection method **O 型端带金属接头**

2 电缆类型 Cable type	型号 Form	芯数 pole x 标称截面 mm ² Number of cores and mm ² per conductor	金属接头 Cable glands	高柔性电缆 Highly flexible	固定安装电缆 Fixed installation	外径 O.D
动力线缆技术参数 Power cable technical data 符合 UL AWM style 20235 CSA	942525	(4 x 2.5) C	M25x1.5	903	904	11.1
温度范围 Temperature range 挠曲 Flexing : -40°C to +80°C 静态 Fixed installation : -50°C to +90°C	942540	(4 x 4.0) C	M25x1.5	905	906	12.9
额定电压 Nominal voltage UL / CSA 1000V VDE	943225	(4 x 2.5) C	M32x1.5	903	904	11.1
动力线 Supply cores : U ₀ / U 600 / 1000V 控制线 Control cores : U ₀ / U 300 / 500V	943240	(4 x 4.0) C	M32x1.5	905	906	12.9
电缆结构 Design 镀锡铜丝编织屏蔽 Tinned copper screen braiding 橙色护套 Orange jacket (RAL 2003) 符合 In according with DESINA [®]	944060	(4 x 6.0) C	M40x1.5	907	908	15.2

3 电缆长度 Cable length	
1.5m	0150
3.0m	0300
5.0m	0500
7.5m	0750
10.0m	1000

订货号 Part No.

例: 942525 — 903 — 0500

1 型号 Form **2** 电缆类型 Cable type **3** 电缆长度 Cable length

备注 Notes

电缆参数 Cable parameter: 10.6.6 配件及技术页面 Accessories and technical page: 10.6.4
不同的电缆长度可根据实际需要, 在订货号的第三部分自行修改, 电缆长度单位: cm

SINAMICS S120 信号电缆

Siemens 标准
 6FX5002 / 6 FX8002
 系列信号控制电缆
 Series of signal control cable
 (DRIVE-CLiQ)

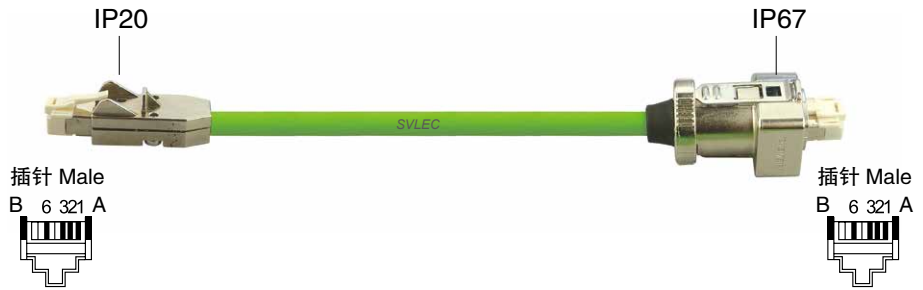

1	型号 Form	No.	IP 20/IP 20	IP 20/IP67	IP 67/IP 67
	两端插头均为金属屏蔽壳体 极数 Suppression		945101	945121	945161
			4(Ethernet)+2(Power)		

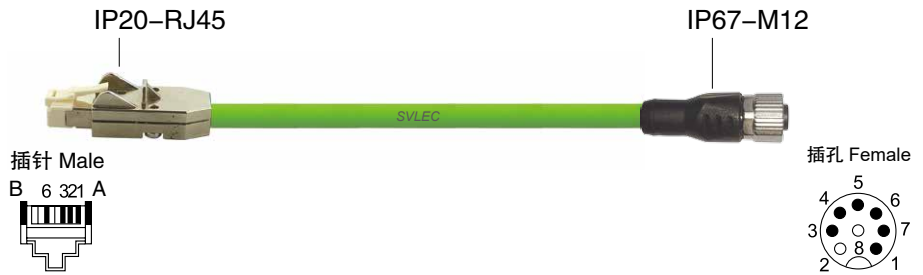

1	型号 Form	No.	IP 20-RJ45/IP67-M12		
	极数 Suppression		945181		
			4(Ethernet)+2(Power)		

2	电缆类型 Cable type	芯数 pole x 标称截面 mm ² Number of cores and mm ² per conductor	电缆 Cable	外径 O.D	应用 Application
		(2 × (2 × 0.2)+2 × 0.38)C PVC	952	7	西门子 Simodrive
		(2 × (2 × 0.2)+2 × 0.38)C PUR	932	7	西门子 Simodrive

	连接器可单独订购 The connector can be ordered separately	No.	IP 20	IP 67
	屏蔽外壳 Shielding enclosure		945010	945020

3	1.5m	0150
	3.0m	0300
	5.0m	0500
	7.5m	0750
	10.0m	1000

订货号 Part No.

例: 945101 - 952 - 0500

1 型号 Form **2** 电缆类型 Cable type **3** 电缆长度 Cable length

备注 Notes

电缆参数 Cable parameter: 10.6.6 配件及技术页面 Accessories and technical page: 10.6.4
 不同的电缆长度可根据实际需要, 在订货号的第三部分自行修改, 电缆长度单位: cm

M23 伺服线束 SERVO APPLICATIONS

伺服标准信号电缆
The servo signal cable standard



1	螺纹型号 Form No.	923149	923147	923279	923276
	快锁型号 Form	923149Q	923147Q	923279Q	923276Q
	极数 Suppression	12-pole / D-SUB 15	12-pole / D-SUB 25	17-pole / D-SUB 15	17-pole / D-SUB 25

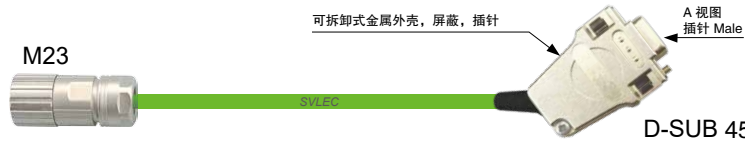

	螺纹型号 Form No.	923129	923127	923179	923176
	快锁型号 Form	923129Q	923127Q	923179Q	923176Q
	极数 Suppression	12-pole / D-SUB 15	12-pole / D-SUB 25	17-pole / D-SUB 15	17-pole / D-SUB 25

M23-M23



	螺纹型号 Form No.	923919	923120	923170
	快锁型号 Form	923919Q	923120Q	923170Q
	极数 Suppression	9-pole	12-pole	17-pole

2	电缆类型 Cable type	芯数 pole x 标称截面 mm ² Number of cores and mm ² per conductor	高柔性电缆 Highly flexible	固定安装电缆 Fixed installation	外径 O.D
电缆结构 Design 导体: 裸铜束绞线和镀锡铜丝束符合 IEC 60228 cl.5 和 cl.6, 改良聚丙烯绝缘, 根据颜色识别芯线。 芯线: 部分对绞, 镀锡铜丝编织层 (覆盖率 ≥ 90%) 镀锡铜排绕线, 薄膜包覆, PE 绝缘层; 线对和芯线绞合薄膜包覆 屏蔽层: 镀锡铜丝编织层 (覆盖率 ≥ 85%) 技术参数 Technical data 额定电压 Nominal voltage: 30V 测试电压 The test voltage: 500V	(2x0.38+3x2x0.22)C	508	/	7.5	
	(2x0.38+4x2x0.22)C	510	/	7.5	
	(2x0.38+5x2x0.22)C	512	/	7.5	
	(4x0.75+(5x0.15)+2x4x0.15)C	716	/	8.9	
	(4x2x0.18)C	930	931	6.4	
	(3x(2x0.14)+(4x0.14)+(4x0.22)+(2x0.5))C	942	939	10.2	
	(4x(2x0.34)+4x0.5)C	944	941	9.6	
	(12x0.22)C	946	945	7.2	
	(4x2x0.14+4x0.5)C	948	955	8.1	
	(3x2x0.25+2x0.5)C	950	958	7.5	
	(10x0.14+2x0.5)C	956	959	7.2	

3	电缆长度 Cable length	
	1.5m	0150
	3.0m	0300
	5.0m	0500
	7.5m	0750
	10.0m	1000

订货号 Part No.

例: 923149 - 508 - 0500

1 型号 Form **2** 电缆类型 Cable type **3** 电缆长度 Cable length

备注 Notes

电缆参数 Cable parameter: 10.6.6 配件及技术页面 Accessories and technical page: 10.6.4
不同的电缆长度可根据实际需要, 在订货号的第三部分自行修改, 电缆长度单位: cm

M23 伺服线束 SERVO APPLICATIONS

伺服标准信号电缆
 Servo signal cable standard



1	型号 Form	No.	990009	990015	990025
	极数 Suppression		D-SUB 9	D-SUB 15	D-SUB 25



	型号 Form	No.	990109	990115	990125
	极数 Suppression		D-SUB 9	D-SUB 15	D-SUB 25

2	电缆类型 Cable type	芯数 pole x 标称截面 mm² Number of cores and mm² per conductor	高柔性电缆 Highly flexible	固定安装电缆 Fixed installation	外径 O.D
	电缆结构 Design				
	导体: 裸铜束绞线和镀锡铜丝束符合 IEC 60228 cl.5 和 cl.6, 改良聚丙烯绝缘, 根据颜色识别芯线。	(2x0.38+3x2x0.22)C	508	/	7.5
		(2x0.38+4x2x0.22)C	510	/	7.5
		(2x0.38+5x2x0.22)C	512	/	7.5
	芯线: 部分对绞, 镀锡铜丝编织层 (覆盖率 ≥ 90%) 镀锡铜排绕线, 薄膜包覆, PE 绝缘层; 线对和芯线绞合薄膜包覆	(4x0.75+(5x0.15)+2x4x0.15)C	716	/	8.9
		(4x2x0.18)C	930	931	6.4
		(3x(2x0.14)+(4x0.14)+(4x0.22)+(2x0.5))C	942	939	10.2
		(4x(2x0.34)+4x0.5)C	944	941	9.6
	屏蔽层: 镀锡铜丝编织层 (覆盖率 ≥ 85%)	(12x0.22)C	946	945	7.2
		(4x2x0.14+4x0.5)C	948	955	8.1
	技术参数 Technical data	(3x2x0.25+2x0.5)C	950	958	7.5
	额定电压 Nominal voltage: 30V	(10x0.14+2x0.5)C	956	959	7.2
	测试电压 The test voltage: 500V				

3	电缆长度 Cable length	
	1.5m	0150
	3.0m	0300
	5.0m	0500
	7.5m	0750
	10.0m	1000

订货号 Part No.

例: 990009 - 508 - 0500

1 型号 Form **2** 电缆类型 Cable type **3** 电缆长度 Cable length

备注 Notes

电缆参数 Cable parameter: 10.6.6 配件及技术页面 Accessories and technical page: 10.6.4
 不同的电缆长度可根据实际需要, 在订货号的第三部分自行修改, 电缆长度单位: cm

伺服信号线束

伺服线束 SERVO APPLICATIONS

Siemens V90

6FX3002 系列

动力控制电缆

Servo harnessing according



1	芯数 pole x 标称截面 mm ² Number of cores and mm ² per conductor	型号 Form	固定安装电缆 Fixed installation	高柔性电缆 Highly flexible	外径 O.D	西门子型号 Siemens type	轴高
	(4x0.75)C	904001	407	417	7.0	6FX3002-5CK01-XXXX	低惯量, 轴高 (20-40mm)



	芯数 pole x 标称截面 mm ² Number of cores and mm ² per conductor	型号 Form	固定安装电缆 Fixed installation	高柔性电缆 Highly flexible	外径 O.D	西门子型号 Siemens type	轴高
	(4x2.5)C	904002	904	903	11.1	6FX3002-5CK31-XXXX	低惯量, 轴高 (50mm)
	(4x1.5)C	904002	902	901	9.7	6FX3002-5CL01-XXXX	高惯量, 轴高 (45-90mm)
	(4x2.5)C	904003	904	903	11.1	6FX3002-5CL11-XXXX	



	芯数 pole x 标称截面 mm ² Number of cores and mm ² per conductor	型号 Form	固定安装电缆 Fixed installation	高柔性电缆 Highly flexible	外径 O.D	西门子型号 Siemens type	轴高
	(4x2.5)C	904002N	904	903	11.1	6FX3002-5CK32-XXXX	低惯量, 轴高 (50mm)
	(4x1.5) C	904002N	902	901	9.7	6FX3002-5CL02-XXXX	高惯量, 轴高 (45-90mm)
	(4x2.5)C	904003N	904	903	11.1	6FX3002-5CL12-XXXX	

电缆长度 Cable length

1.5m	0150
3.0m	0300
5.0m	0500
7.5m	0750
10.0m	1000

订货号 Part No.

例: 904001 - 407 - 0500

1 型号 Form **2** 电缆类型 Cable type **3** 电缆长度 Cable length

备注 Notes

电缆参数 Cable parameter: 10.6.6 配件及技术页面 Accessories and technical page: 10.6.4
不同的电缆长度可根据实际需要, 在订货号的第三部分自行修改, 电缆长度单位: cm

伺服线束 SERVO APPLICATIONS

Siemens V90
 6FX3002 系列
 编码器线缆
 The encoder cables



1	芯数 pole x 标称截面 mm ² Number of cores and mm ² per conductor	型号 Form	固定安装电缆 Fixed installation	高柔性电缆 Highly flexible	外径 O.D	西门子型号 Siemens type	轴高
	(3x(2x0.22)+2x2x0.25)C	904010	102	112	7.0	6FX3002-2CT20-XXXX	低惯量 (20-40mm) 增量式编码器
							
	(3x(2x0.22)+2x2x0.25)C	904040	102	112	7.0	6FX3002-2DB20-XXXX	低惯量 (20-40mm) 绝对值编码器
							
	(3x(2x0.22)+2x2x0.25)C	904020N	102	112	7.0	6FX3002-2CT12-XXXX	低惯量 (50mm) / 高惯量 增量式编码器
	(3x(2x0.22)+2x2x0.25)C	904030N	102	112	7.0	6FX3002-2DB12-XXXX	低惯量 (50mm) 绝对值编码器
							
	(3x(2x0.22)+2x2x0.25)C	904020	102	112	7.0	6FX3002-2CT10-XXXX	低惯量 (50mm) / 高惯量 增量式编码器
	(3x(2x0.22)+2x2x0.25)C	904030	102	112	7.0	6FX3002-2DB10-XXXX	高惯量 (45-90mm) 绝对值编码器
电缆长度 Cable length							
	1.5m	0150					
	3.0m	0300					
	5.0m	0500					
	7.5m	0750					
	10.0m	1000					
订货号 Part No.							
	例:	904010	102	0500			
		1 型号 Form	2 电缆类型 Cable type	3 电缆长度 Cable length			
备注 Notes							
电缆参数 Cable parameter: 10.6.6 配件及技术页面 Accessories and technical page: 10.6.4 不同的电缆长度可根据实际需要, 在订货号的第三部分自行修改, 电缆长度单位: cm							

伺服线束 SERVO APPLICATIONS

Siemens V90
6FX3002 系列
抱闸电缆
Brake cable



1	芯数 pole x 标称截面 mm ² Number of cores and mm ² per conductor	型号 Form	固定安装电缆 Fixed installation	高柔性电缆 Highly flexible	外径 O.D	西门子型号 Siemens type	轴高
	(2x0.75)C	904004	207	267	6.0	6FX3002-5BK02-XXXX	低惯量, 轴高 (20-40mm)



	芯数 pole x 标称截面 mm ² Number of cores and mm ² per conductor	型号 Form	固定安装电缆 Fixed installation	高柔性电缆 Highly flexible	外径 O.D	西门子型号 Siemens type	轴高
	(2x0.75)C	904005	207	267	6.0	6FX3002-5BL02-XXXX	低惯量 (50mm) 高惯量 (45-90mm)



	芯数 pole x 标称截面 mm ² Number of cores and mm ² per conductor	型号 Form	固定安装电缆 Fixed installation	高柔性电缆 Highly flexible	外径 O.D	西门子型号 Siemens type	轴高
	(2x0.75)C	904005N	207	267	6.0	6FX3002-5BL03-XXXX	低惯量 (50mm) 高惯量 (45-90mm)



	芯数 pole x 标称截面 mm ² Number of cores and mm ² per conductor	高柔性电缆 Highly flexible	西门子型号 Siemens type	数据线
	12 x 0.14mm ²	706	6SL3260-4MA00-XXXX	20 芯 I/O 电缆
	50 x 0.08mm ²	550	6SL3260-4NA00-XXXX	50 芯设定值电缆

电缆长度 Cable length	
1.5m	0150
3.0m	0300
5.0m	0500
7.5m	0750
10.0m	1000

订货号 Part No.

例: 904004 - 207 - 0500

1 型号 Form **2** 电缆类型 Cable type **3** 电缆长度 Cable length

备注 Notes

电缆参数 Cable parameter: 10.6.6 配件及技术页面 Accessories and technical page: 10.6.4
不同的电缆长度可根据实际需要, 在订货号的第三部分自行修改, 电缆长度单位: cm

连接器附件 ACCESORIES

配件 Accessories	型号 Type	订货号 Part No.	
	V90 控制电缆 14 芯连接器, 驱动侧 6FX2003-0SB14	990014	
	V90 控制电缆 20 芯连接器, 驱动侧 6SL3260-2MA00-0VA0	990021	
	V90 控制电缆 50 芯连接器, 驱动侧 6SL3260-2NA00-0VA0	990051	
	V90 控制电缆 12 芯连接器, 电机侧 6FX2003-0SL12	990012	
	V90 动力 4 芯连接器, 电机侧 (含针) 6FX2003-0LL13	923401T	
	Ø2 mm 插孔 Female 1.00 - 2.50 mm ²	926201	
	V90 抱闸 2 芯连接器, 电机侧 (含针) 6FX2003-0LL53	917202T	
	V90 增量编码器 8 芯连接器 (3 个卡槽), 电机侧 (含针) 6FX2003-0SL13	917803T	
	Ø1 mm 插孔 Female 0.14 - 1.00 mm ²	916221	
	驱动器侧插头 (动力) 西门子 Drive side plug (power) of Siemens	999148	
	伺服插头公针 Male		
	线径 Wire	1.5mm ² CPM - 1.5	999148-15
		2.5mm ² CPM - 2.5	999148-25
		4.0mm ² CPM - 4.0	999148-40
		6.0mm ² CPM - 6.0	999148-60

连接器附件 ACCESORIES

名称 Designation		型号 Form	订货号 Part No.
	带有适用于 C/D 型电机模块的螺钉式接线端子的电源连接器	6SL3162-2MA00-0ACO	963162
	驱动器侧插头 (编码器) 西门子 IP20 Drive side plug (encoder) of Siemens		945010
	驱动器侧插头 (编码器) 西门子 IP65 Drive side plug (encoder) of Siemens		945020
保护盖 Blind plug 	M23 信号插孔保护盖 (金属) The signal jack protection cover (metal)	RC-S-PMC	996030
保护盖 Blind plug 	M23 信号插针保护盖 (塑料) The signal pin protection cover (plastic)	RC-S-BPC	996010
保护盖 Blind plug 	M23 动力插针保护盖 (塑料) Power pin protection cover (plastic)	RC-P-BPC	996110
保护盖 Blind plug 	M23 信号插针保护盖 (金属) The signal pin protection cover (metal)	RC-S-BMC	996020
安装环 Install the ring 	M23 信号安装环 Signal installation ring	RC-S-M	999231
	M23 动力安装环 Power installation ring	RC-P-M	999232
工具 Tool			
	信号插针压线钳 The signal pin wire clamp	CPT-S	999991
	M23 动力插针压线钳 Power pin pressing line clamp	CPT-P	999992
	M40 动力插针压线钳 Power pin pressing line clamp	CRIMVBOX-6.0/10.0	600001002

电缆技术参数 TECHNICAL PARAMETERS FOR CABLES



伺服 servo	导线直径 wires diameter	拖链安装 Suitable for C-track	护套 Jacket	外径 mm Outer-Ø	弯曲半径 Bend radius mobile	温度范围 Temperature range 静态 Fixed °C 动态 Mobile °C
417	(4×0.75)C	适合 Yes	PUR	approx. 7.5	8 × outer-Ø	-40...+80 -25...+80
407	(4×0.75)C	不适合 No	PVC	approx. 7.5	10 × outer-Ø	-40...+80 -25...+80
901	(4×1.5)C	适合 Yes	PUR	approx. 9.5	8 × outer-Ø	-40...+80 -25...+80
902	(4×1.5)C	不适合 No	PVC	approx. 9.5	10 × outer-Ø	-40...+80 -25...+80
903	(4×2.5)C	适合 Yes	PUR	approx. 10.0	8 × outer-Ø	-40...+80 -25...+80
904	(4×2.5)C	不适合 No	PVC	approx. 10.0	10 × outer-Ø	-40...+80 -25...+80
905	(4×4.0)C	适合 Yes	PUR	approx. 12.1	8 × outer-Ø	-40...+80 -25...+80
906	(4×4.0)C	不适合 No	PVC	approx. 12.1	10 × outer-Ø	-40...+80 -25...+80
907	(4×6.0)C	适合 Yes	PUR	approx. 15.2	8 × outer-Ø	-40...+80 -25...+80
908	(4×6.0)C	不适合 No	PVC	approx. 15.2	10 × outer-Ø	-40...+80 -25...+80
911	(4×1.5+(2×1.0))C	适合 Yes	PUR	approx. 11.1	8 × outer-Ø	-40...+80 -25...+80
912	(4×1.5+(2×1.0))C	不适合 No	PVC	approx. 11.1	10 × outer-Ø	-40...+80 -25...+80
913	(4×2.5+(2×1.0))C	适合 Yes	PUR	approx. 13.6	8 × outer-Ø	-40...+80 -25...+80
914	(4×2.5+(2×0.75))C	不适合 No	PVC	approx. 13.6	10 × outer-Ø	-40...+80 -25...+80
915	(4×4.0+(2×1.0))C	适合 Yes	PUR	approx. 14.2	8 × outer-Ø	-40...+80 -25...+80
916	(4×4.0+(2×1.0))C	不适合 No	PVC	approx. 14.2	10 × outer-Ø	-40...+80 -25...+80
917	(4×6.0+(2×1.0))C	适合 Yes	PUR	approx. 16.5	8 × outer-Ø	-40...+80 -25...+80
918	(4×6.0+(2×1.0))C	不适合 No	PVC	approx. 16.5	10 × outer-Ø	-40...+80 -25...+80
921	(4×1.5+2×(2×1.0))C	适合 Yes	PUR	approx. 14.5	8 × outer-Ø	-40...+80 -25...+80
922	(4×1.5+2×(2×1.0))C	不适合 No	PVC	approx. 14.0	10 × outer-Ø	-40...+80 -25...+80
923	(4×2.5+2×(2×1.0))C	适合 Yes	PUR	approx. 15.5	8 × outer-Ø	-40...+80 -25...+80
924	(4×2.5+2×(2×1.0))C	不适合 No	PVC	approx. 14.6	10 × outer-Ø	-40...+80 -25...+80
925	(4×4.0+2×(2×1.0))C	适合 Yes	PUR	approx. 16.8	8 × outer-Ø	-40...+80 -25...+80
926	(4×4.0+2×(2×1.0))C	不适合 No	PVC	approx. 16.0	10 × outer-Ø	-40...+80 -25...+80
927	(4×6.0+2×(2×1.0))C	适合 Yes	PUR	approx. 19.2	8 × outer-Ø	-40...+80 -25...+80
928	(4×6.0+2×(2×1.0))C	不适合 No	PVC	approx. 19.2	10 × outer-Ø	-40...+80 -25...+80
930	(4×2×0.18)C	适合 Yes	PUR	approx.6.4	8 × outer-Ø	-40...+80 -25...+80
931	(4×2×0.18)C	不适合 No	PVC	approx.6.4	10 × outer-Ø	-40...+80 -25...+80
932	(2×(2×0.2)+2×0.38)C	适合 Yes	PUR	approx.7.0	8 × outer-Ø	-40...+80 -25...+80
939	(3×(2×0.14)+(4×0.14)+(4×0.22)+(2×0.5))C	不适合 No	PVC	approx.10.2	10 × outer-Ø	-40...+80 -25...+80
941	(4×(2×0.34)+4×0.5)C	不适合 No	PVC	approx.9.6	10 × outer-Ø	-40...+80 -25...+80
942	(3×(2×0.14)+(4×0.14)+(4×0.22)+(2×0.5))C	适合 Yes	PUR	approx.10.2	8 × outer-Ø	-40...+80 -25...+80
944	(4×(2×0.34)+4×0.5)C	适合 Yes	PUR	approx.9.6	8 × outer-Ø	-40...+80 -25...+80
945	(12×0.22)C	不适合 No	PVC	approx.7.2	10 × outer-Ø	-40...+80 -25...+80
946	(12×0.22)C	适合 Yes	PUR	approx.7.2	8 × outer-Ø	-40...+80 -25...+80
948	(4×2×0.14+4×0.5)C	适合 Yes	PUR	approx.8.1	8 × outer-Ø	-40...+80 -25...+80
950	(3×2×0.25+2×0.5)C	适合 Yes	PUR	approx.7.5	8 × outer-Ø	-40...+80 -25...+80
952	(2×(2×0.2)+2×0.38)C	不适合 No	PVC	approx.7.0	10 × outer-Ø	-40...+80 -25...+80
955	(4×2×0.14+4×0.5)C	不适合 No	PVC	approx.7.2	10 × outer-Ø	-40...+80 -25...+80
956	(10×0.14+2×0.5)C	适合 Yes	PUR	approx.8.1	8 × outer-Ø	-40...+80 -25...+80
958	(3×2×0.25+2×0.5)C	不适合 No	PVC	approx.7.5	10 × outer-Ø	-40...+80 -25...+80
959	(10×0.14+2×0.5)C	不适合 No	PVC	approx.7.2	10 × outer-Ø	-40...+80 -25...+80
102	(3×(2×0.22)+2×2×0.25)C	不适合 No	PVC	approx.7.0	10 × outer-Ø	-40...+80 -25...+80
112	(3×(2×0.22)+2×2×0.25)C	适合 Yes	PUR	approx. 7.0	8 × outer-Ø	-40...+80 -25...+80
508	1P×0.38+3P×0.22	适合 Yes	PUR	approx. 7.5	8 × outer-Ø	-40...+80 -25...+80
510	1P×0.38+4P×0.22	适合 Yes	PUR	approx. 7.5	8 × outer-Ø	-40...+80 -25...+80
512	1P×0.38+5P×0.22	适合 Yes	PUR	approx. 7.5	8 × outer-Ø	-40...+80 -25...+80
716	4×0.75+(4×0.15)+2×4×0.15	不适合 No	PUR	approx. 8.9	8 × outer-Ø	-40...+80 -25...+80
207	(2×0.75)C	不适合 No	PVC	approx. 6.0	10 × outer-Ø	-40...+85 -25...+80
267	(2×0.75)C	适合 Yes	PUR	approx. 6.0	8 × outer-Ø	-40...+85 -25...+80
550	50 x 28AWG	不适合 No	PVC		10 × outer-Ø	-40...+80 -25...+80