

**ARKLED** 无锡市方舟科技电子有限公司

WUXI ARK TECHNOLOGY ELECTRONIC CO., LTD

## 规格(承认)书

Specification for approval

※ 方舟 P/N (ARKLED P/N): SR420563N

※ 客户 P/N (CUSTOMER P/N): \_\_\_\_\_

※ 产品说明 (DESCRIPTION):

1、

2、

3、

※ 日期 (DATE): 2011 年 10 月 20 日

地址: 江苏省宜兴市张渚镇金张渚工业区宇龙路 6 号

ADD: NO.6 Yulong Road, ZHANGZHU TOWN, YIXING CITY, JIANGSU PROVINCE,  
P.R.CHINA

电话 (TEL): 0086-510-87341161 87345700

传真(FAX): 0086-510-87342800

E-mail: [arkled@arkch.com](mailto:arkled@arkch.com)

网址(http) : [www.arkch.com](http://www.arkch.com)

型号 Type :

SR420563N



■ 产品特征 FEATURES:

- 高可靠性和高稳定性

**High intensity and reliability**

- 高品质、和低功耗、低成本

**High quality, Low power requirement and low cost**

- IC 易兼容、易装配

**IC compatible , Easy assembly**

- 符合 RoHS 指令要求

**Meet RoHS EU Directive**

- 静电承受能力 2000V

**ESD 2000V**

■ 产品描述 DESCRIPTION:

- 0.56 英寸四位数码管

**0.56 Inch Four Digits Display**

- 极性共阴

**Common Cathode**

- 黑面, 白胶

**Black face, white segment**

- 发光颜色

**Lighting Color:**

1、红色 RED

2、

3、

4、

5、

- 晶片材质

1、AlGaInP

2、

3、

4、

5、

型号 Type :

SR420563N



■ 产品最大绝对参数值 (Ta: 25℃) ABSOLUTE MAXIMUM RATINGS AT Ta=25℃:

PARAMETER 项目	SYMBOL 符号	RED 红色	UNIT 单位
Power Dissipation Per Segment 功耗	PAD	50	mw
Reverse Voltage Per Segment 反向耐压	VR	5	V
Continuous Forward Current Per Segment 最大使用电流	IAF	20	mA
Peak Forward Current Per Segment(Duty-0.1,1KHz) 最大峰值电流	IPF	60	mA
Operating Temperature Range 工作温度	TOPr	-20℃ to 80℃	
Storage Temperature Range 贮藏温度	Tstg	-30℃ to 85℃	
Lead Soldering Temperature 260℃ at 1.6mm From Body for 3 second 焊接温度 260℃/3秒 距离胶体 1.6mm 以上			

■ 产品光电参数值 (Ta: 25℃) ELECTRICAL/OPTICAL CHARACTERISTICS AT Ta=25℃:

PARAMETER 项目	SYMBOL 符号	TEST CONDITION 测试条件	Color 颜色	MIN 最小值	TYP 标准值	MAX 最大值	UNIT 单位
Forward Voltage ,Per Segment 正向压降	VF	IF=20mA	红色 RED	1.9	2	2.5	V
Reverse Current , Per Segment 反向漏电流	IR	VR=5V	红色 RED			50	μA
Peak Emission Wavelength 峰值波长	λp	IF=20mA	红色 RED	630	633	637	nm
Luminous Intensity Per Segment 法向光强	IV	IF=20mA	红色 RED	23	25	28	mcd

型号 Type :  
SR420563N



Fig 1. Forward Current vs. Forward Voltage

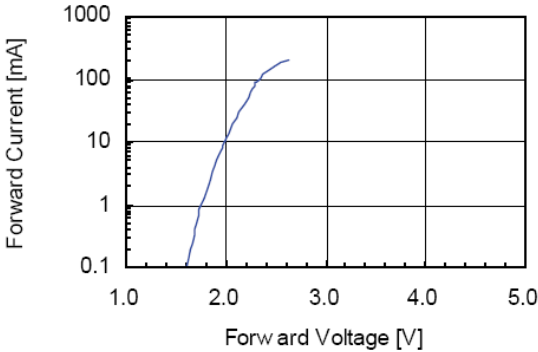

Fig 2. Relative Intensity vs. Forward Current

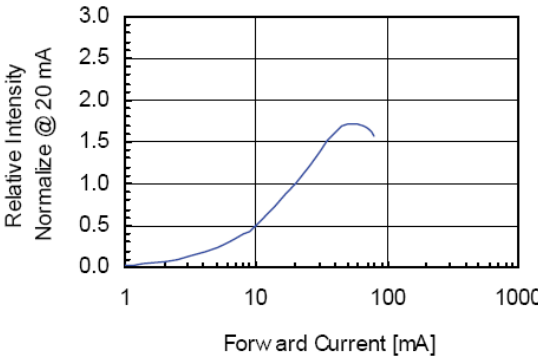

Fig 3. Forward Voltage vs. Temperature

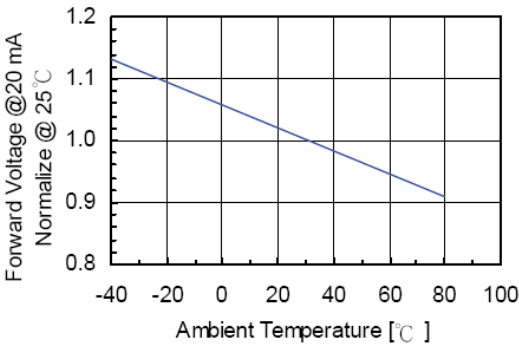

Fig 4. Relative Intensity vs. Temperature

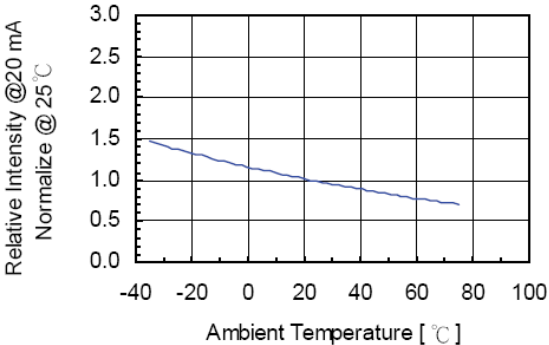
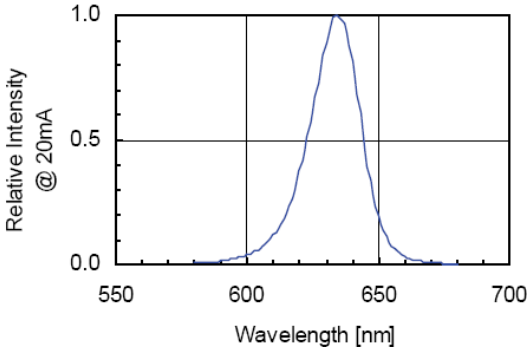
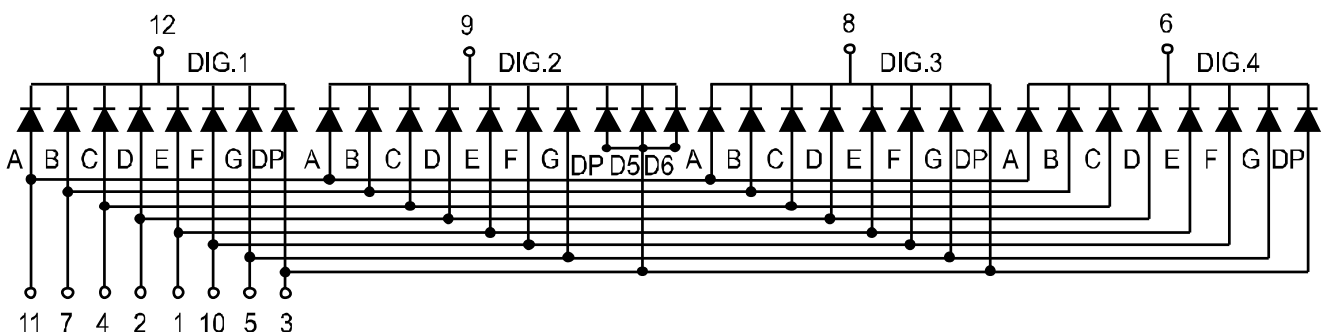
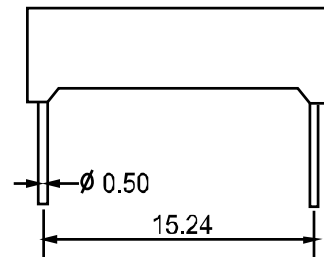
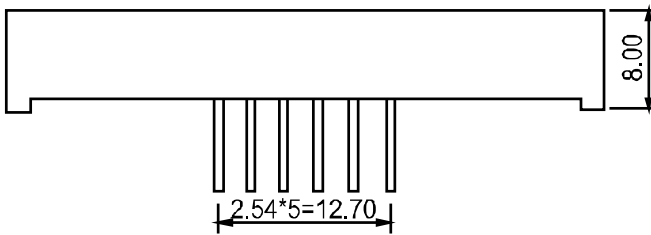
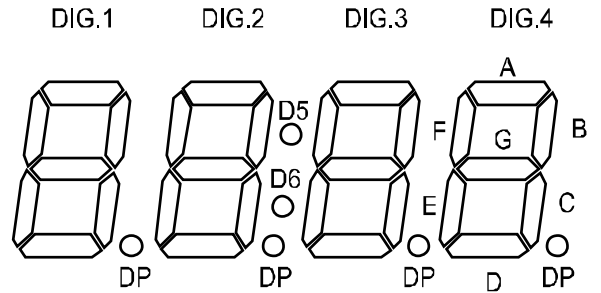
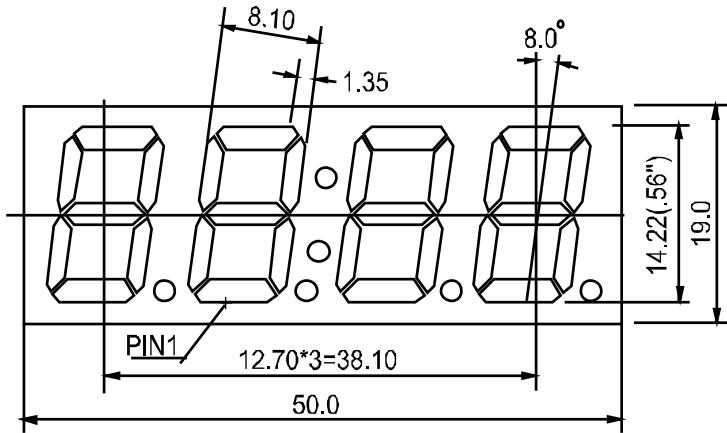

Fig 5. Relative Intensity vs. Wavelength



型号 Type :

SR420563N



NOTES : 1. All dimensions are in millimeters. (inches)

2. Tolerance is  $\pm 0.25(0.010)$  unless otherwise specified.